

Ինքն շնորհիվ Ի Ե՞ն Կրթական Գործառն

Principles of Educational Administration and Management

EDM 2351

Գրքի Այն Գրքի Կրթական



Երևանի Կրթական Գործառնի Կրթական



This book is licensed under a
Creative Commons Attribution 4.0 International License.

ikÿv cËvmb I e'e`tcbvi gj-bwiz

EDM 2351

GgGw tcÜMg

cËvkKvj

cËg gÿY: Wtm±†, 2000

cb: gÿY: 2004, 2005

cb: gÿY: Rvbgmi, 2012

cb: gÿY: Gicj, 2014

cÜ`

KvRx mvBdžxb&AveŸm

KvúDUvi K±úvR Ges WwUvc

tgw: RvKi trvmb

© eisj v`k D>gÿ nekte`vj q

ISBN 984-34-0060-7

cËvkbvq

cËvkbv, gÿY I weZiY wefvM

eisj v`k D>gÿ nekte`vj q

MvRxcj- 1705|

gÿY

eisj v evRvi tcn GÜ cvevj †Kkb

53 b_@K nj tivW, eisj v evRvi

XvKv- 1100|

tKvmeB AbyiY Kivi KuhRi ciqk©

icq ikyvLx©

Dgy ikLb cxwZ wbfP GgGW ikyv tcmMgti fuzqI qvi Rb" **ġ Ae GwKkb** AvcbtK Avšhi K Awfb`b Rvbt"Q| ikŋv ckvmb I e"vcvri gj-bmZ (EDM 2351) tKvmeBw GgGW tcmMgti wZxq chŋqi wekIvqb tytI GKwU tKvmeB| GB tKvmp Df'k" nj ikŋv ckvmb I e"vcvri mautK"cwK avi Yv jvf AvcbtK mnvqZv Kiv| Avkv Kiv hvq, Avcvb GB eBtq Dc"mCZ cvV,tj vi gva'tg weliU mautK"mVK avi Yv jvf KiZ myg nteb Ges ikyv ckvmb I e"vcvri tytI bZb wPšlariv I wofwz ARšb myg nteb|

G tKvmeBwU ciw" weliq gj-Z: ikyv ckvmb I e"vcvri tytI ,iazcy© cŋqvRbxq etj wewPZ KtqKwU tytI tK" Kti wewfbacvtVi gva'tg Dc"vcvri Kivi tPov Kiv ntqtQ| Avkv Kiv ntqtQ Avcvb hw" G,tj v gtbvthw mnkvti cv Kti b Zte GZ" weliq GKwU mvgwMK I "Q avi Yv jvf mg_nteb|

EDM 2351 tKvmeB

ciw I Abyj tbi tytI Avcbt`i KiYq ik?

- "ikLb cxwZi gj- K_vB nj wbtR wbtR cto tklv Ges wbtRi tPovq tklv| Ab" K_vq, G cxwZi gva'tg ikyv_r"bR` wqtZj wbtRi mjevav gtZv mgtq tklvi Kvtr wbtqvmRZ nb| e"ġ G Df'k"tK mvgtb tiLB **ġ Ae GwKkb**-Gi wewfbacvtVimP eB,tj v iwPZ| GtZ fveMZ HK" iyv Kti cvtVi weliq tK KZ,tj v BDwbU fvm Kiv ntqtQ| Avevi BDwbU,tj tK KZ,tj v cvtV fvm Kiv ntqtQ| cŋZwU cv cŋwKfite GKevi cotZ Avcbvi 40-45 wgvbu mgq jvmte etj ati tklv ntqtQ| cŋZwU BDwbUi tktI Avcvb wbtRB wbtRi cv AMwZ gj"vqb KiZ cvi teb| G Rb" cvtVi tktI cvtVvEi ckgvjv iqtQ|
- tKvmeB covi mgq wK wK KvtrI I ci ,iazjw tZ nte?
 - cvtVi gj"vqtb ckg,tj vi DEi wbtR wbtR Kiab| Avcbvi DEi,tj v mVK nj wK bv, Zv cvtVi weliq **"chŋyY Kti wbtRB wvavPY Kiab**|
 - cvtVvEi gj"vqtb me,tj v cŋk" mVK ntj cieZrBDwbU GwMtg hvb|
 - Avcbvi DEi,tj v mVK bv ntjv cvV,tj v cob| cov tkl ntj cvtVvEi gj"vqb ckg,tj vi DEi Kiab| DEi mVK ntj ci ci cvtV GwMtg hvb|
 - tKv cvtV me,tj v cŋk" DEi mVK bv ntj tm cvtVi wv" Ask Avevi cob| Gfite cŋZwU BDwbUi cvV,tj v tkl Kiab|

eBwU tZ th mg`wbt`Rbvj-K wPy e"eyZ ntqtQ tm,tj v nj :

	DxwZ		cvtVvEi gj"vqb
	cvw wewwZ		mVK DEi

- cvV-mnvqK KgmPv
 - GB eBwU Qvovl **ġ Ae GwKkb**-Gi mmeR ZEjearv AvtqvmRZ`vbxq GgGW ÷wW tmUvti Avcbvi Rb" cŋZ gvtm (2q-4`A_ev 1g-3q iµevi) `BwU wDwtUwv qj tmktbi e"v MhY Kti tQ| Gme tmktb thw w tq Avcvb eBwU tKv Ask ev cvV cotZ wMtg tKv mgm"vq cotj tm weliq cŋqvRbxq ciqk" wbt`Rbv MhY KiZ cvtI b|
 - tiwW I wvftZ cŋZ mBvtn Avcbvi Rb" cvw weliq wvfwEK mnvqK tmktbi e"v iqtQ| Avcvb wvavw Z mgtq Nti efm Gme tmktb AskMhY Kti mskw tytI Avcbvi mgx KiZ cvtI b|

miPcĪ

	cĪW	cĪU
BDĪBU 1	Īkĳŷ cĳumb I e'e-Īcbvi gj bwiZ I avi Yv	01
1	cĳumb I e'e-Īcbvi avi Yv I msÁv	02
2	Īkĳŷ cĳumb I e'e-Īcbvi A_, msÁv I gj bwiZ	06
3	Īkĳŷ cĳumb I e'e-Īcbvi msμvšĪ Kŷhvewj	10
4	Īe`ĳ q cwi Pĳj bĳq Īkĳŷ cĳumb I e'e-Īcbvi ĳ i æZĳ	14
BDĪBU 2	Īkĳŷ cĳumb I e'e-Īcbvi HĳZnumK cĪUfĳg	17
1	ĪPĳvqZ msMv ZĒĳ	18
2	mĳgmiRK msMv ZĒĳ	22
3	Dĳg ³ Īmĳ÷g ZĒĳ	26
BDĪBU 3	Īkĳŷ cĳumb I e'e-Īcbvi AMÖZ	29
1	g'v- ĳfĳei (1864-1920): Avgj vZšĳAMÖZ	30
2	ĳdWwi K DBŷĳj v tUj i (1856-1915): eÁvmbK e'e-Īcbvi RbK	33
3	ĳnbix d'vqj (1841-1925) Ges j yvi ĳuj K: cĳumbK cĳμqvi cĒ ³ v	37
4	Gj Ub tgĳqv (1880-1949): gvbwēK m=úK ZĳĒĳi cĒ ³ v	41
BDĪBU 4	mĳMvmbK Kwiĳgv: ĳcĳŷZ eisj vĳ ĳki gva'ĳgK Īkĳŷ	45
1	Īkĳŷ gšĳŷj q: msMv, ĳwqZĳ I Kŷhvewj	46
2	gva'ĳgK I D'Pĳkĳŷ Aĳa`Bi	50
3	AvÁĳj K Īkĳŷ cwi `Bi I ĳRj v Īkĳŷ Avdĳmi ĳwqZĳ I Kŷhvewj	54
BDĪBU 5	Kgx^ēe-Īcbv	57
1	Kgx ^ē e-Īcbvi A_, ĳ i æZĳ I cĳqviRbĳqZv	58
2	Īkĳŷ_ĳ ^ē ĪkĳŷK I mĳvqK Kgx ^ē i e'e-Īcbv	61
3	Kgx ^ē e-Īcbvi nĳZqvi I ĳKšĳj	64
BDĪBU 6	cĳumb ĳbZZĳ	67
1	ĳbZĳZĳi A_, msÁv I avi Yv	68
2	ĳbZĳZĳi UĳBc ev ai b	71
3	`ĳj i ĳbZv ĳmĳĳe cĳZōvb cĳvĳbi ĳwqZĳ KZ ^ē I ĳ Yvewj	76

cW 1

cġvmb I e'e`vcbv aviYv I msÁv

Dt'ik

GB cW tkfI Avcib—

- cġvmb Ges e'e`vcbv kã `vbi A_@j tZ Ges e'vL'v I wektY Ki tZ cvi teb;
- kã `vbi e'rcuE m'úK@j tZ cvi teb Ges
- cġvmb I e'e`vcbv cvi `úwi K m'úK@bifcY Ki tZ cvi teb|

cġvmb- A_@ msÁv

cġvmb kãu eú c@pib| hLb t_#K gvby `j ex ntq emevm Ki tZ wklj, ZLb t_#KB cġvmbi c@qvRbxqZv cwi j wŷZ nj | thLvfbB tKvb `j ev mSMVb we`gvb, tmLvfbB cġvmbi Dcu`wZ j ŷ Kiv hvq| cġvmbi BstiwR c@Zkã Administration| Ad t_#K we'ObæKti Ministration kãu e'rcuE MZ A_@ w_#K ZvKvtj Avgiv t`L tZ cve Gi A_@n`Q 0Kv'iv Rb` gtbvthvM t`qv0 ev 0hZæKiv0| GB A_@cġvmbtK Avgiv tmevgj-K KvR ev c@pqr ej tZ cwi | tKvb c@Z0vb ev mSMVtbi j ŷ ev Dt'ik` AR#bi Rb` KvR KivtK tevSvq| Aciw`#K, evsjv cġvmb ktãi A_@Kitj `wvq c0+ kvmb| GLvfb kvmb kãu kvw`c0v'bi BwZ enb Kti | hv I cġvmb wbgg, bwiZ I k;Ljvi cġe RiwZ, Z_wic AvaybK A_@cġvmbi tmevgj-K w KivB c@v' tctq Avm'Q| mSMVb gv'IB Dt'ik`g'x| c@Zw mSMVb wKQybw`0 j t'ŷi w_#K avegib| j ŷ ev Dt'ik` AR#bi Rb` MpxZ m'p'wšZ I m'w'w Pw'j Z e'e`vi bvgB cġvmb|

e'e`vcbv- A_@ msÁv

The International Encyclopedia of Higher Education Vol-6 G e'e`vcbv th msÁv t`qv ntqtQ Zv'j, "Management may be defined as the process of activating and integrating the capacities of an enterprise to attain optimum results with a minimum expenditure of resources."¹ A_@ `fZg m'ú`i m'v'vth` mte'EG dj v'j cvevi j t'ŷ tKvb c@Z0v'bi m'v_#K Ktg'wB I m'g'wšZ Kiv| e'e`vcbv g'tj i'qtQ e'w³ ev personnel Ges Dt'ik` n`Q mte'EG e'w³ ev Kg' wbtqvm Ges mte'EG e'w³ ev Kg' wBKU t_#K me'wK dj j v'f| The World Book Encyclopedia, Vol- 8 G ejv ntqtQ, "Management is the art and practice of managing a business or industry It may be described as "making do" or making the best of available resources."² e`Zctŷ e'emv, emYR` Ges wki t'ŷt'IB e'e`vcbv kãu e' c0g Awef'f|

¹ The International Encyclopedia of Higher Education, Vol-6. p-1692

² The World Book Encyclopedia, Vol-8, P-73

čkymb I e'e-vcbv

čkymb I e'e-vcbv i avi Yv m³útk³KLbI KLbI *uk*ḡ³me` Ges gbxl³ i gta` cv³ R`
t`Lv hvq| *evsj* vq *eýrc*EMZ A³č³čkymb n³Q KivD³K čkó.*ev DrKó.i,fc KivR KižZ*
eva` Kiv Ges člqvRtb kv³l³weavb Kiv| GLv³tb kvmb káiU AwaKZi čl³avb` čv³Q|
*Bst³i³R Administration káiU eýrc*EMZ A³č³tmev *ev Kj`vYg³-K D³t³k`³ vbtq tKvb*
*ukQ³j mýze`e-vcbv³t³ tevSvq| GLv³tb tmev *ev Kj`vY káiUi čl³avb` AwaK| Aa³v**
eú³tḡ³t³B čkymb A³č³ḡ³v e'e-vcbv káiU e`en³ti i čl³Z čl³Y³Zv j ḡ³ Kiv hv³t³Q| tKvb
tKvb ukḡ³me` čkvmK káiUi čvi e³t³Z³tmeK káiU e`en³ti i čḡ³cv³Z|

avi Yv *inm³te čkymb káiU A³tbK čl³P³xb| mý³- AZxZ t³čKB i vó³ čvi P³vj bv, tmb³ev³mbx*
ev ag³ḡ čl³Z³ovb čvi P³vj bvi tḡ³t³ káiU e`eüZ n³tq Av³m³Qj | Ac³i³v³čK e'e-vcbv
káiUi D³me n³tq³Q uk³í-³ve³tei č³i | GB káiU uk³í čl³Z³ovb, e`emv Ges Private
Sector ev temi K³vix ms³-vi m³t³½ AwaKZi m³ú³,³ | ḡ³ž³e`emvqx ev ewYK m³ú³ú³tq³ v³bR
v³bR e`emv čvi P³vj bv c³x³vZ t³čK e'e-vcbv káiUi Av³ve³f³e| "The methods of
management have developed from the comparatively simple, direct way of
running a business that merchants and owners of small factories practised in
the 1700's".³

e'e-vcbv káiU *Drc³v³bg³yx* (Production Oriented) *Ges Kg³ḡ³yx* (Activity
Oriented)| *Ac³i³v³čK čk³vm³t³bi`³ v³ḡ³ v³eva v³bq³ ev Av³Bb K³vby čl³qv³t³Mi v³čK AwaKZi*
v³bex (Application of Rules and Regulations)| *čk³vm³t³bi KivR b³m³Z v³ba³f³Y,*
čvi K³íbv čl³qb, v³m³x³v³š³ M³ḡ³Y, čvi P³vj b Ges v³bq³š³| e'e-vcbv³ KivR v³be³f³ix`³ v³q³Z;
č³v³j b| čk³ymb tKvb v³ḡ³ j ḡ³ AR³bi Rb` b³m³Z v³ba³f³Y I čvi K³íbv čl³qb K³ti,
e'e-vcbv³ KivR t³m³B b³m³Z I čvi K³íbv ev³é³vq³ Kiv| e³-Z³č³ḡ³ čk³ymb I e'e-vcbv ká
`³ v³ḡ³ G³t³K Act³i i m³v³č³ N³v³ô³f³v³te m³ú³,³ | čk³vm³t³ thgb čvi K³íbv čl³qb, v³m³x³v³š³ M³ḡ³Y,
v³ḡ³č³ Rbv, v³bq³š³ I m³g³š³q m³vab KižZ nq; e'e-vcbv³t³KI tZ³gvb GB GKB čl³qv³q³ KivR
KižZ nq| čk³ymb nj čvi K³íbv I v³m³x³v³š³ M³ḡ³Y K³ti uk³ KižZ n³te Ges e'e-vcbv nj
čvi K³íbv I v³m³x³v³š³ M³ḡ³Y K³ti uk³f³v³te Zv m³ú³v³ b ev ev³é³vq³ KižZ n³te| uk³ḡ³v³t³ḡ³t³ ZvB
KLbI i³ayč³čk³ymb, KLbI i³aye`e-vcbv Av³evi KLbI čk³ymb I e'e-vcbv GK³m³t³½
e`eüZ n³tq Av³m³t³Q|

evsj v³t³č³ki *gva`³vgK ukḡ³vi tḡ³t³ m³te³P b³m³Z v³ba³f³Yx A³½ in³t³te ukḡ³v gš³v³j tqi*
Ae³-vb| Gici č³h³ḡ³μ³t³g gva`³vgK I D³ḡ³ukḡ³v Awa`³Bi, Av³Á³v³j K čvi`³Bi, tR³v³ ukḡ³v
A³vdm I ukḡ³v čl³Z³ovb, v³v³ i³tq³Q| ukḡ³v gš³v³j q th b³m³Z I čvi K³íbv M³ḡ³Y K³ti ukḡ³v
Awa`³Bi, čvi`³Bi, tR³v³ A³vdm Ges me³f³KI av³č³ ukḡ³v čl³Z³ovb, v³v³ t³m³B b³m³Z I čvi K³íbv
ev³é³vq³t³bi`³ v³q³t³Z; v³ḡ³t³qv³RZ| t³m³B v³K t³čK v³eteP³bv Ki³t³ ukḡ³v gš³v³j tqi KivR³t³K
čk³vm³ubK Ges Awa`³Bi, čvi`³Bi, tR³v³ ukḡ³v A³vdm Ges v³e`³v³j q, v³v³ i`³ v³q³Z³t³K
e'e-vcbv³ KivR in³t³te Av³L³v³q³Z Kiv hvq| uk³š³ GK³v³ v³ḡ³ v³e`³v³j tqi čl³avb hLb Z³v³
v³bR v³e`³v³j q čvi P³vj bvi Rb` čvi K³íbv čl³qb I v³m³x³v³š³ M³ḡ³Y K³ti b, ZLb v³Zv³ čk³vm³ubK

³ The World Book Encyclopedia, Vol-8, p-73.

`vqZB cvj b Kti _vtKb| GZŋŋi Avtj vPbv t_ŋK cŹxqgvb nq th, cŹŌvŋbi D"PZi
chŋq cŋvmb AwakZi , iazcŸŸ Aciw ŋK, cŹŌvŋbi wbgrechŋq e'e`vcbv AwakZi
, iazcŸŸ we`'ij ŋqi GKRB wŋŋK hLb avtc avtc cŋ`vbŋZ cŸŌ nŋq cŋvb wŋŋK cŋ`
AwawŌZ nb, ZLb Zwi cŋvmbK `vq`vqZ; AŋbK teŋo hvq| wKŠ' cwi Kí bv Ges wmxvš
ev`évtŋbi tŋŋŋ wŋŋKMYB , iazcŸŸŋgKv cvj b Kti _vtKb|

divmx wíciwZ I cŋvmbK tnbŋx tdqj (1841-1925) Zwi MŠ' Administration
Industrielle et Generale (1916) MŠ' Dŋŋ KŋŋŋQb "Management process
consists of planning, organisation, command, co-ordination and control."
e'e`vcbv mŋvš Awakvsk cŋŋK tdqŋi G avi Yv Abŋŋi Y Kiv nŋ"Q| tdqŋi gŋZ
cwi Kí bv, mŋMb, wŋŋ`R, mgšŋ Ges wŋqšŋ e'e`vcbv cŋŋvŋi AŠMŋ| cŋvmb mŋvš
Avtj vPbv t_ŋKI `úóZ cŋvŋYZ nq th, cŋvmbK KgŋvŌI GKB cŋŋvŋq AvewZŋ|



cV#VĒi gj`iqb: 1

A) eū ubePbx cĕæ

m#WK DĒi ũb#`Rgj-K Aŋi#U#K eĒv#qZ Kiab| (D`vniY: Avcbvi ũbe#PZ DĒi#U K ntj G#K (K) eĒv#qZ Kiab)

1. ũb#Pi tKvb `e#kó#U cĕv#t#bi tŋ#Ī A#KZi c#hvR`?
 K. cĕv#b GK#U Kg#y# c#u#v
 L. cĕv#b GK#U Drcv`bg#y# c#u#v
 M. cĕv#b GK#U e`#3#K#`K c#u#v
 N. cĕv#b GK#U D#Ī k`g#y# c#u#v|

2. ũe`vj q c#i P#j b#i tKvb ch#q cĕv#b A#KZi , i#z#y#?
 K. D`PZi ch#q
 L. ũbg#Zi ch#q
 M. g# ch#q
 N. mKj ch#q|

3. e`e`vc#vi gj# ũb#Pi tKvb ũR#b#i#U ũe`g#b?
 K. Drcv`b
 L. k#
 M. e`#3 ev Personnel
 N. m#M#b|

Av) iPb#q#-K cĕæ

1. Avcbvi ũe`vj #qi c#i P#j b#i m#m#š#`b#`b K#h#e#j mg#ni m#ŋ#B ũe#i Y ũ`b| G mKj K#h#e#j i tK#b#U cĕv#b Ges tK#b#U e`e`vc#vi m#½ A#KZi m#ú#3? m#y#ú#f#te ũP#y#Z Kiab|



m#WK DĒi

- A) 1| N, 2| K, 3| M|

cW 2

ւկղյւ շկմբ I ԷԷ՛ւՅբւի A_©msÁv I գյ-բմՆ

Dřİk

GB cW řkřI Avııb—

- **ւկղյւ շկմբ I ԷԷ՛ւՅբւի msÁv cŃvb KiřZ cvi řeb;**
- **ւկղյւřřřİ ւկղյւ շկմբի Avıefře mıúřKıvi Yv cŃvřb mřřg nřeb;**
- **ւկղյւ շկմբ I ԷԷ՛ւՅբւի ԷւկŃmğř DřjŁceŘ Ab`vb` շկմբի mř½ ւկղյւ շկմբի cv_Ř` ıbiřY KiřZ cvi řeb Ges**
- **ւկղյւ շկմբի գյ-բմՆ_ıj DřjŁ KiřZ cvi řeb|**

ւկղյւ շկմբ I ԷԷ՛ւՅբւի A_©

ceŃZř cıřV շկմբ I ԷԷ՛ւՅբւ mıúıKŹ AvřjıPbvi řcŃřřřZ ւկղյւ շկմբ I ԷԷ՛ւՅբւիK mgAř_©enri Kiv AvıKZi hıŸMŃh`| Ávřbi GKıU c_ıK kvLv ııřmře ւկղյւ շկմբ I ԷԷ՛ւՅբւի weKıvKıj Ly řeık ı řbi bq| Ebıesk kZıvıxi řkI ı řK GKıU ˆqsmıúYıelq ıııře ւկղյւ շկմբի Avıefře NřUřQ| ԷԷ՛emv շկմբի mıdj` I AMŃııZ wek kZıvıxi ıııřř hıŸıřŃŃı ւկղյւe`řı DrmıııZ Křı řZřj | Zıııv ԷԷ՛emv շկմբի řřřİ cŃıj Z ZĒ; a`vb-avi Yv I bııZgıj vřK ւկղյւřřřİ cŃqıřM mřPŃ nb|

ւկղյւ շկմբ I ԷԷ՛ւՅբւ ej řZ ւկղյւLvřZ cŃB mıúř`ı mřefřeg ԷԷ՛enřııı mıııřh` ւկղյւ j řř` I Dřİk` ARřbi cŃıqıřK řevSıq| A_ř ւկղյւ j řř` I Dřİk` ev`Ēvqřbi Rb` mıııeŘ th Kıvřeg ZıřKB ւկղյւ շկմբ I ԷԷ՛ւՅբւ ej v nq| th řKıv cŃZŃvřbi gĒ` Dřİk` nř`Q cŃZŃvřbi m`m`ııı`ı ııqZ; I Kıvřeıj ı mğzıngŹq mıvab Kıv hıřZ cŃZŃvřbıU Zıı BıııZ j řř` řcŃŃıřZ cıřı| ւկղյւ cŃZŃvřbi řřřİ GB gĒ` Dřİk` ւկLb-řkLvřbv cŃıqıřK ıNřı AvııZř| AZGe ւկղյւ cŃZŃvřbi řřřİ ւկղյւ շկմբ I ԷԷ՛ւՅբւի գյ-DcRıe` nj, ւկLb-řkLvřbv cŃıqıřı Dbqřb| "The central purpose of administration in any organization is that of coordinating the efforts of people toward the achievement of its goals. In education these goals have to do with teaching and learning. Thus, administration in an educational organization has as its central purpose the enhancement of teaching and learning."⁴

ւկLb I řkLvřbı KıvR Z_ı cŃZŃvřbi ւկղյւ Dbqřbi j řř` GKRB cŃZŃvřb cııřbi hv KıYıq Zı nj :

1. cŃZŃvřbi Rb` j řř` I bııZ ıbıřıY Kıv,
2. j řř` I Dřİk` ARřbi Rb` mııK KğeıııZ ıbYq,

⁴ Introduction to Educational Administration, 5th Edition, Roald F. Campbell, Edwin M. Bridges, Raphael O. Nystrand, chapter 4, Page 102.

- 3. cwi Kí bv cŕqb I ev-évqb Kv#Ri mgšq mvab Kiv,
- 4. A#_P ms-#b Kiv Ges
- 5. Dc#iv³ Kv#eij m#úv`#bi t#t# cŕZóv#bi `#Zv I Kv#Rvvi Zv gj-#qb Kiv|

tKvb GKRB uk#me`#i g#Z, "The purpose of educational administration is to enable the right pupils to receive right education from the right teachers at a cost within the means of the state, under conditions which will enable the pupils to profit from their training." A_# ivóiq A_#bZK mvg#_P g#a` Dch# uk#t#Ki #v#v GKRB Dch# uk#v_#Ggb GK#U Ae-# ev cwi #ek Dch# uk#v M#t#Y mg_#te th Ae-# ev cwi #ek Zvi uk#v M#t#Yi Rb` m#e#Eg nte Ges th uk#vi gva`tg tm Zvi R#e#bi m#e#Eg dj jvf Ki#e|

uk#v c#vm#bi gj- DcR#e` gvb#| e-#³ gvb#| i D#vzi ga` w`#q mg#ó i D#vZ Z_# mgMó t`k I R#vzi D#vZ uk#v c#vm# I e`e-#cbvi j#`| `# uk#v c#vm# I e`e-#cbv m#p uk#v e`e-#i m#v#th` t`#ki Rb#M#v#t#K Rb#v#t#Z i#v#šhi Z Ki#Z c#i, th Rb#v# mei Kg D#q# KgR#v#Úi #bqv#K|

G hver Av#j vPbvq -úóZB tevSv tMj uk#vi j#` I D#i`k` ev-évq#bi Rb` m#e#R th Kv#e#g Z#t#KB uk#v c#vm# ev e`e-#cbv ejv th#Z c#i | uk#v c#vm# gj-Z #e`ij q msM#b, cwi P#j bv I #b# R#vi m#t# m#úv³ | Gi D#i`k` RvZ#q ch#q t_#K i i#K#i gv# ch#q ch#S uk#vi D#q#b, c#vi I #e#v#k m#vab| uk#vi gva`tg gvb#t#K Zvi m#g#v#Zv t_#K gv# t`I qv uk#v c#vm#bi KvR|

t`Lv hvq, Kv#i c#v#n mg#qi cwi eZ#bi av#vq D#v#sk kZv#xi tkl w`#k GK#U c_#K kv`#n#v#te uk#v c#vm#bi Av#e#e#| t#v#K c#vm#, e`emv c#vm# I uk#i c#vm# t_#K D#vZ uk#v c#vm#bi `e#kó`v#v#t#Z G m#Kj c#vm#bi uk#Qy#v#e #e`g#v _#Kv #e#P#i bq| GZ`m#E#i #elq #n#v#te uk#v c#vm# GK#U `Z#; `e#kó` `e#kó`g#ÚZ| uk#v c#vm#b jvf#v#Zi c#v# tM#Y| Aciv#t#K e`emv ev uk#i c#vm#b jvf#v#Zi c#v# g#e`| uk#v c#vm#bi j#` AR# m#y#j#c#v#x| e`emv c#vm#bi b#vq Zv#v#v#YK dj #e#P#i uk#v c#vm#bi _i#Z; Ab#v#b m#e bq|

uk#v c#vm# I e`e-#cbvi gj-b#vZ

th tKvb Kg#m#úv`#bi Rb` uk#Qy#v#q Kv#t#bi c#qv#Rb i#t#Q| m#P#v#šZ I ms#v#e# GB #b#q#v#v#y Kg#m#úv`#b#K Zj#v#šZ K#i Ges w`K #b# #Kv #n#v#te KvR K#i | uk#v c#vm# I e`e-#cbvi t#t#I tZg#v uk#Qy#v#q#b#v#Z i#t#Q| G m#Kj #b#q# b#v#t#K uk#v c#vm# I e`e-#cbvi gj-b#vZ #n#v#te #e#e#P#v Kiv hvq| GB gj-b#vZ, vj uk#v c#vm# I e`e-#cbvi Kv#R M#Z c#v# K#i Ges cŕZóv#bi j#` I D#i`k` AR#bi #b#q#k #n#v#te KvR K#i | GKRB uk#v c#vm#K ev e`e-#cb#K#i Rb` G m#Kj #b#q# b#v#Z R#v#v Acv#v#v#q gj-b#v#Zi m#v#K Ab#v#i Y c#vm#bi KvR#K m#R K#i Ges msM#b ev cŕZóv#t#K B#vZ j#t#`i w`#k #b#q hvq| #b#P Gi#c uk#Qy#v#b#v#Z Z#j aiv nj :

1. cġvmġKi Rb` Rvbr AZ`vek`K th cġvmb GKU Dġġk`gġx cġuqv| mslMVġbi Dġġk` ARġbi Rb` mslMVb ev cġZōvb msukō m`mġi `vqZj| Kg[©]mġbō ō Kiv Ges cġZōvġbi e`MZ Dcv`vġbi cġŲ I mteġĒg e`envi ubōōZ Kiv cġqvRb|
2. cġvmb GKU AZ`vek`Kxq mġvġRK Ges gvbġeK cġuqv| KvġRB cġZōvġbi gvbġ Z_v `j m[©]ġġK[©]Rvbr cġvmġKi Ab`Zg KvR| gvbġġK KvġR jvMġġbvi KvRġUġK mnR Kivi Rb` gvbġġK Rvbr Z_v `ġj i gvbġġ i e`w[©]Zj; AvPiY I Pwv`v m[©]ġġK[©] mRvM ġġK cġvmb Kvġ[©]vi Pj br Kiv DĒg|
3. thġnZzġkġv cġZōvb GKU mġvġRK Bbġ=UDkb, GLġġb Superordinate-Subordinate Relationship ev EaZb Aa`b m[©]ġġK[©] cġġġ weivRgub| cġZġU Mġc ev `ġj i Kg[©]ev m`mġi Rb` mġbō ō Kg[©]xġZ Ges bġZgġj v_vKv evĀbġq|
4. Dchŷ e`w[©]ġġK Dchŷ `vqZj;cġvb DĒg e`e`vcbvi `enkō`|
5. cġZġU Kg[©]ev m`ġm`i Rb` KvġRi h_vh_gġ` ubġfcY ev ,Y wePvġi i e`e`v_vKv cġvmġbK bġZgġj vi Aweġ`Q` A½|
6. cġZōvġbi mKj m`ġm`i Rb` Kg[©]ZġBi e`e`v KvġR Avb` t`q Ges KvġRi ,YMZ gvb ew[©]ġġZ mġvqZv Kġi |
7. ġġKġ`iġK GKvġWġK `vaxbZv cġvb ġġvi gġbġbġġbi mġvqK|
8. cġZōvġbi Rb` Dchŷ I mġġġ ġġK ubġqm cġvmġbi Ab`Zg KvR| mteġ[©]vi,
9. cġZōvġbi Kg[©]ġvġ GKU mġbō ō ubqg I e`e`v ōvivi cġvPwġj Z nI qv evĀbġq| GġZ j ġġ` ARġ mnR nq| "The management must lay down an efficient system for getting the work done."⁵

⁵ The World Book Encyclopedia, Vol-8, P-73.



ci#Vēi gj`iqb: 2

A) eū ibePbx cĕæ

m#WK DĒi ubt`Rgj-K AŋiuU#K eĒv#qZ Kiab| (D`vniY: Avcbri ube#PZ DĒiuU K ntj G#K (K) eĒv#qZ Kiab)

1. ukŋv cĕv#mbi gj- DcRxe` tKvbiU?
 - K. we`ij q
 - L. gvby
 - M. ukŋvμg
 - N. ukŋK|

2. ukŋv cĕv#mb I e`e`vcbri hveZxq KgRvŪ tKvbiU#K #N#i Ave#Z` nq?
 - K. ukŋv_#
 - L. ukŋK
 - M. ukLb-tkLv#bv cĕμqv
 - N. ukLb mvgM#|

3. ukŋv cĕv#mb I e`e`vcbri gj-b#vZ ej #Z tKvbiU#K tevSvq?
 - K. `b#`b Kvk i#U#b cĕv#b
 - L. m#P#S#Z I m#v#e#x #bqg Kivly Abyri Y
 - M. Av#`k ubt`R Rvix
 - N. ci#ŋv M#Y|

Av) iPbv#j-K cĕæ

1. we`ij q c#i Pvj b#i tŋ#t ukŋv cĕv#mb I e`e`vcbri m#μ#s#l th mKj gj-b#vZ Avc#b Abyri Y K#i _v#Kb, Zvi GK#U m#vŋ#B c#i #P#Z c#vb Kiab| GB m#½ gj-b#vZ m#k# th mKj `v#qZ; Ges Kiv#e#j Avc#b cij b K#i b Zvi weei Y # b|



m#WK DĒi

- A) 1| L, 2| M, 3| L|

cW 3

ukŋv cġvmb I e`e`vcbv mspvšġ Kvhŋej

Dġġk

GB cW tkġl Avġvb—

- weifbankŋve` Ges gbxlx KZR.c0Ē ukŋv cġvmb cġvqv weifbav` K Dġġ KġZ cviġeb;
- ukŋve` ev gbxlx`i c0Ē ukŋv cġvmb cġvqv mspvšġ Kvhŋej e`vL`v KġZ cviġeb;
- ukŋv cġvmb mspvšġ Kvhŋej i msvŋB cvi vPvZ c0vb KġZ mŋg nġeb|
- ukŋv cġvmb mspvšġ Kvhŋej i e`vBx ev cvi mi Dġġ KġZ cviġeb|

ukŋv cġvmb I e`e`vcbv mspvšġ Kvhŋej

e`vck Aġ`Ab`vb` cġvmtbi mġ½ ukŋv cġvmb mspvšġ Kvhŋej i tZgb tkvb cv`R` tbB| 1916 mġġ tnbix tdqj "Elements of Management" ejġZ th KqW cġvqv K_v Dġġ KġġQb, tgvUvgvġfġte cġvmb RMġZ AvRI tm avivB Ae`vnZ iġġQ| tdqj Zui wkġ c0Z0vġbi Avf`AZv t_ġK th cġvqv, vj i K_v Dġġ KġġQb, tm, vj nġ`Q cvi Kġbv, msvMb, vb`R, mgšġ Ges vbqšġ (Planning, Organizing, Commanding, Co-ordinating and Controlling) | GB cġvqv, vj ġK vZvb cġvmbK `vqZ; ev KvR vnmġte AvL`vqZ KġġQb| Zui gġZ, "Together these activities constituted the administrative function."

tdqjġK AbyiY Kġ cieZġZ j_yvi MġġK (Luther Gulick) th dġskb ev KvġRi Dġġ KġġQb tm, vj i Av`vŋi vbġq vZvb `Zui KġġQb POSDCORB| hŋivġof tġmġWġUi `vqZ; m`úġK`vZvb cġvġġġLġQb, "What is the work of the chief executive?0 ZviB DEġi POSDCORB Gi Avvefġe| POSDCORB e`vL`v Kġġ `vq Planning, Organizing, Staffing, Directing, Co-ordinating, Reporting, Budgeting.

Gi AvU eQi ci mġBgb (Aerbert A. Simon) tdqj Ges MġġġKi KvġRi m`úġviY Kġib Ges Zvġ`i DġġġZ Kvhŋej ġK v`všġMġY KvVġgvi gġa` vetePbvġ cġvm civ| msvMġbi v`všġ MġY cġvqvġ veteKġYKġġ tdqj Ges MġġġKi b`vq mġBgb| Planning, Budgeting, Controlling Ges Co-ordinating ġK vetePbvq Avġbb| e`Ztġġ tdqj Ges MġġK c0Ē c0ZvU dġskbġKB vZvb v`všġ MġġYi AvL`vq veteKġġYi tP0v KġġQb|

cieZġZ vj Pvdġ (Edward H. Litchfield) tdqj, MġġK Ges mġBġbi KvġġK AbyiY Kġ cġvmbK cġvqvġ GKvU aviYv `Zui c0P0v tbb| GB cġvqvġK vZvb `vq Pġµ Zġġ aġib| Gġ`i GKvU nj mveġ ev epr Pµ (Administrative Process as a

should see that there is no unnecessary encroachment of their academic rights and personal liberty.”⁷

- **ukŋK Ges ukŋv_ŋ Dfŋi Rb** mŋzCode of Conduct ev AvPiY wewa _vKv evĀbxq|
- **ukŋvμŋgi mdj ev`ėvqb GKiu AvZ ,iaZcŸ©cŋvmmbK KvR| tkŋYKŋŋi cVb-cvVb cŋμqvi Dci m`v RvMZ `wó tiŋL we`ij q cĀvb G `vŋqZjU m`úbrKiŋeb|**
- **ukŋvμŋgi mdj ev`ėvqŋbi Rb** GKivŋvŋgK Kvŋŋeij thgb ,iaZcŸ©tZgub mn-cvμŋgK Kvŋŋeij i mdj ev`ėvqbl Acwi nvhŋ
- **we`ijŋi Rb** Aŋ_ŋ ms`vb Ges we`ijŋi Avq-e`ŋi mŋzvmveiŋŋŋi tŋŋĀ we`ij q cĀvbŋK Aek`B mRvM Ges mZK©_vKv evĀbxq|
- **ukŋvi e`vŋb thgb e`vcK I wekvj , ukŋv cŋvmb mŋμvŋŋ Kvŋŋeij i e`vŋBl tZgub mŋjŋ we`Z| GKiu vbw`ŋ vŋqŋgi evvŋŋi I GKRb ukŋv cŋvmKŋK wevfbœAcZ`vŋkZ `vŋqZjcvj b KiŋZ nq|**

Dctiv³ AvŋvPbvi tċŋŋŋZ we`ij q cŋvmb I e`ėvcbv mŋμvŋŋ Kvŋŋeij i GKiu mri-msŋŋc cŋvb Kiv thŋZ cvŋi :

- we`ij q cwi Pvj bv mŋμvŋŋwevfbœeI q m`úŋK©bŋZ vbaŋŋ Y I cwi Kí bv cŋqb|
- vŋxvŋŋMŋY I vŋxvŋŋev`ėvqbKŋŋi c`ŋŋc MŋY|
- Avŋ_ŋ e`ėvcbv mŋμvŋŋ `vŋqZjcvj b/Avq-e`ŋi vŋvŋe i vLv/cŋŋ m`úŋ`i h_vh_e`envi vbwŋZKiY|
- KgŋukŋŋK vŋŋqŋM I Ziv`i tckvMZ Dbŋŋb mŋŋvM Ges mŋvqZv cŋvb|
- GKivŋvŋgK e`ėvcbv Z_v ukŋv Kvŋŋeij Dbŋŋb I ev`ėvqŋbi Rb` hveZŋq c`ŋŋc MŋY|
- ukŋv_ŋ`i Pvv`v ci-Y I Ziv`i tj Lvcovi mŋvqK cwiŋek `Zwi |
- EaŋZb KgŋZŋŋmsŋkŋ `Bi I mŋvŋRi gvŋŋi i mŋ½ thvMŋŋvM I m`úK©`vcb|

eZŋvb cwi evZŋ mŋgŋRK tċŋŋŋŋU GKiv ŋK thgb wevfbœmŋvŋi D^me nŋ`Q, tZgub ukŋvŋŋŋĀ Dŋbŋ NUŋQ be be fveavi vi | we`ij q cĀvbŋi `vŋqZj I KZŋe`i gvŋv e`vcK t_ŋK e`vcKZi nŋ`Q| G ,ia`vŋqZj cvj bKŋŋi cŋvmmbK Avb I `ŋZv Acwi nvhŋ we`ijŋi j ŋŋ I Dŋŋk` ev`ėvqŋbi gvŋŋg t_ŋki mŋveŋ ukŋv e`ėvi j ŋŋ I Dŋŋk` ev`ėvqŋbi tŋŋĀ GKRb cŋZŋvb cĀvbŋi `vŋqZj I KZŋe`i ,iaZj Acwi mŋg| G mZ`vU gŋb tiŋL cŋZvU we`ij q cĀvbŋK `^`^`vŋqZjcvj ŋbi e`vcŋŋi mŋPó nŋZ nŋe|

⁷ L.D. Gupta, Educational Administration, Oxford and IBH Publishing Co Pvt Ltd, Delhi, Bombay, Calcutta, P-39.



cv#VĒi gj`vqb: 3

A) eū ubePbx cĕæ

m#WK DĒi ubt`Rgj-K AŋiuU#K eĒv#qZ Kiab| (D`vniY: Avcbvi ube#PZ DĒi#U K ntj G#K (K) eĒv#qZ Kiab)

1. cĕv#mbK cĕ#qv# tŋ#T POSDCORB-Gi cĕ^{3v} tK?
K. j y#i M#y# K
L. tdqj
M. m#Bgb
N. #j P#d# |
2. cĕv#mbK cĕ#qv#tK tK#b #t#k# Ā P#v#K#i Dc`vcb K#i#Ob?
K. j y#i M#y# K
L. tdqj
M. m#Bgb
N. #j P#d#

Av) iPb#qj-K cĕæ

1. #kŋ#v cĕv#mb I e`e`vcb# m#p#vš# K#v#e#y# m#ú#v`#bi gva`tg #Kf#v#e #e`v#j #qi j ŋ# I D#i`k` ev`é#vqb K#v h#q# D`vni Y#m#K#i #j L#y|



m#WK DĒi

A) 1| K, 2| L|

cW 4

we`ij q cwi Pvj bvg ukʻŋv ckwmb I e`e`vcbvi , iaz;

Dʻi`k`

GB cW tkʻl Avcb—

- we`ij q cawtbi `vqZ; I KZʻe`i cwi na mʻutKʻAvtj vKcvZ KiʻZ cvi teb Ges
- ukʻŋv ckwmb I e`e`vcbvi Avb ukʻfite GKRb ukʻŋv ckwmb KʻK w`K ubʻRbv cʻvb Kʻi Zv meʻkʻY KiʻZ cvi teb|

we`ij q cwi Pvj bvg ukʻŋv ckwmb I e`e`vcbvi , iaz; Avtj vPbvi cʻvʻtj GKRb we`ij q cawtbi `vqZ; I KZʻe`i cwi na Dci mvgub` Avtj vKcvZ Kiv thʻZ cvʻi | we`ij q cawtbi `vqZ; I KZʻe`i cwi na tKej gvʻl we`ij q cʻvʻtʻi i gʻa`B mvgvex bq, we`ij q PZʻi i enntʻi l Zui KZʻe`i cwi na we`Z | GB `vqZ; I KZʻe`i cwi gʻUjʻK vbgvj ulZfite t`Lvʻbv thʻZ cvʻi :

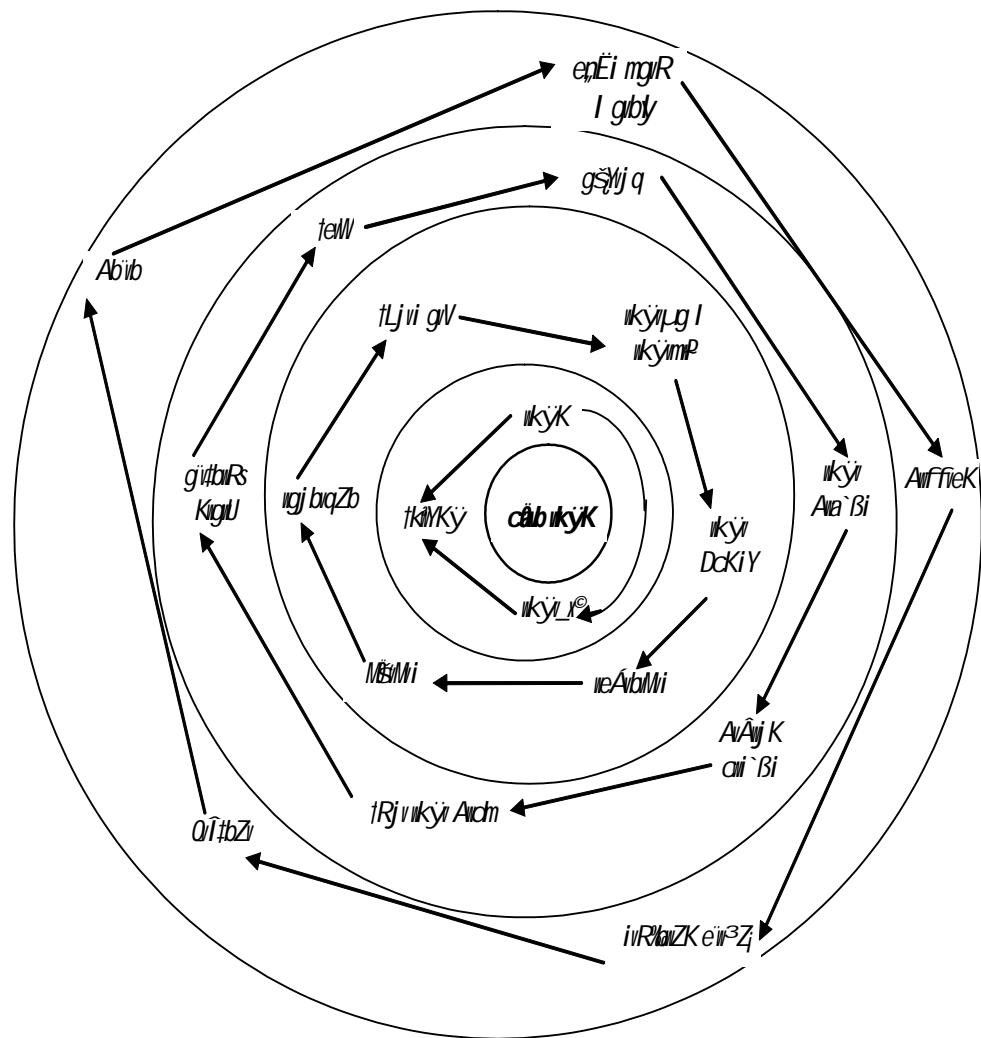

ḡ Ae GW#Kkb

c0E wPḤ t_#K GKRb we`ij q cāv#bi `wqZ;I KZ#e`i cwi wai tgvUvgnj GKwU avi Yv
civI qv hvq| we`ij q cāv#bi `wqZ;ev Kv#Ri cwi gU#j weiwRZ i#qtQ-

- we`ij #qi ewntcwi tek Z_v ewnt#i mgvR Ges mgv#Ri m`m`e, AwffveK, QvḤ#bZv, ivR%bWZK e`w³Z;BZ`w` |
- gšYij q, Aw`Bi, cwi`Bi, tRj v Awdm, tevW, g`v#bW#Rs KvgwU BZ`w` |
- Af`š#xY cwi tek Z_v tk#YK#q, wK#qK Ges wK#qV_#q
- wK#qV_#g, wK#qV_#mP, wK#qV DcKiY|
- t#šZ KvV#tgv Z_v K#j R feb, wqj b#qZb, weAvb#Mvi, MšvMvi, tLj vi gvV|
- we`ij #qi Ab`vb` KgPvi#e,` |

we`ij q cāv#bi cāvb wnmv#te GKRb cāvb wK#qK#K GB cwi gUj m#ú#K#mRwM_vK#Z
n#e| GKRb cāvb wK#q#Ki KvR wK? G c0k# DEi c0vb L# mnR bq| we`ij #qi
cwi`vi cwi`Qb#v I k;Lj v i#qV t_#K i#æ K#i ewnt#i mgv#Ri m#½ thvM#thvM eRvq
ivLv I wewfba#Pvc Ges mgm`vi tgvKv#ej v A_# we`ij #qi w#Zi I ewni GB Dfq w`K
m#ú#KB Zv#K mRwM I Zrci_vK#Z nq| cāvb wK#q#Ki me#c#qV , i#z#p# wqZ; n#`Q
we`ij #qi GKv#WwqK gvb eRv#qi e`vcv#i m`v Zrci_vKv| wK#q#Ki cv`vb, wK#qV_#q
civ M#Y, wK#qV_#g I wK#qV_#mPi mdj ev`#vqb, civ#qV M#Y I cwi Pvj bv, MšvMvi Ges
weAvb#Mv#i h#_vch# e`envi wbu#ZKiY, mncvW#wqK Kvh#ej i mdj ev`#vqb BZ`w`
cāZwU t#q#TB cāvb wK#q#Ki m`v RvM#Z `w#_vKv ev#b#q| AZGe t`Lv hv#`Q, `wqZ; I
KZ#e`i e`vck I wekvj cwi gU#j mv_# I mdj fv#te wePiYK#i we`ij q cāv#bi Rb`
wK#qV cāvmb I e`e`vcv#i Avb Acwi nvh#

wK#qV cāvmb I e`e`vcv#i Avb GKRb cāvb wK#qK#K we`ij q cwi Pvj b#q h_vh_ w`K
w#t`Rbv c0vb Ki#e| wK#qV cāvmb I e`e`vcv#q Awf# GKRb we`ij q cāvb wba#j wLZ
t#qḤ mg#n Zui Avb I c#Av#K Kv#R j wM#q mdj Kvq n#Z cv#i b t

- K. cwi Kí bv c0#qb|
- L. wmxvš#M#Y|
- M. c0qvRb#q Ges Ki Y#q Kvh#ej wPw#ZKiY|
- N. Kvh#ej#qi tk#Yw#b`im|
- O. mgm` mbv³KiY I mgvavb wby#q|
- P. we`ij #qi GKv#WwqK gv#bv#q#bi j #q` Kvh#ej M#Y|
- Q. we`ij #qi mwe# gv#bv#q#bi j #q` Kvh#ej M#Y|
- R. Kvh#ej gj`vqb|
- S. gj`vqb cieZ#e`e`v M#Y|

ukŋv RvZiq Dbq̄tbi ceRZ[⊗] th RmZ hZ teuk ukwŋZ, Zvi Av_ŋmvgvRK wfZI ZZ gReZ| ukŋvi Dbq̄b ubf[⊗] Kti mŷzl ewj ô ukŋv cġvmb I e`e`rcbvi Dci| ukŋvi Dbq̄tbi j tŋ` cġ_xi Dbz I Dbq̄bkxj t`k_s,ij ukŋv e`e`rcbvtK weÁvb wfiEK I MYgubŷi Kj`vYwfiEK Kivi j tŋ` Avšhi Kfite mŷPó| Avgvt`i we`ij q_s,ij i cġvmb I e`e`rcbvi gj-j ŋ` nte ukŋv_ŋ, ukŋK, ukŋv cġZôvb Z_v t`tki mmeR ukŋv e`e`ri Dbq̄b mvab|

t`tki ukŋv e`e`ri gvV chŋq Avgvt`i we`ij q_s,ij i Ae`vb| GB cġvmb I e`e`rcbvi mteP chŋq itqtQ ukŋv gšYij q Ges Gici chŋqμŋKfite itqtQ Awa`Bi, cwi`Bi, tRjv Avdm BZ`w | ukŋv gšYij q t`tk i iæ Kti we`ij q chŋq chš cġZw tŋtĪB mŷwi Pvj bvi Rb` wv` ŋ AvBb Kvbly I ubqgbmZ itqtQ| G mKj AvBb Kvbly I ubqg bwiZi h_vh_ AbyiY, mdj cġqvM Ges ev`evqtbi gta` weÁvb wfiEK e`e`rcbvi wfZ wbinZ|



cġVvEi gj`vqb: 4

A) eú ubePbx cġæ

mŷWK DĒi ubt`Rgj-K AŋiŋWtK eĒmŋZ Kiab| (D`vniY: Avcbvi ubePZ DĒiŋW K ntj GtK eĒmŋZ Kiab)

1. we`ij tqi emtcwi tek ej tZ tKvb aitbi cwi tek tK teiSvq?
 - K. we`ij tqi AvZ ubKtUi cwi tek
 - L. we`ij tqi Pvi t`qvtj i emntii cwi tek
 - M. tkŷKtŋi emntii cwi tek
 - N. we`ij tqi tLjvi gvV|

2. we`ij q cġvtbi meŋcŋv_s iæZcY[⊗] vŋqZ; tKvbŋW?
 - K. QvTukŋK mŷúKŋRvi`vi Kiv
 - L. cġZôvtbi e`MZ mŷt`i e`envi wvŋZKiY
 - M. we`ij tqi GKvŷŋqK gvb eRvq ivLvi e`vcvti mŷPó_vKv
 - N. ukŋKt`i mŷ½ mŷŷúKŋRvq ivLv|

Av) iPbŋj-K cġæ

1. we`ij q cwi Pvj bvq ukŋv cġvmb I e`e`rcbvi_s iæZ; e`vL`v Kiab| ukŋv cġvmb I e`e`rcbvi Ávb ukfite GKRB we`ij q cġvtK mrvh` Ki tZ cvti?



mŷWK DĒi

A) 1| L, 2| M|

fygKv

we`ij q mgvŋRi B A½| mgvŋRi Ab`vb` A½ ev mSMVtbi Zj bviq we`ij q mæZ meŋPtq teik RiUj cwi teŋk cwi Pvi Z nq| we`ij tqi KgrvU cwi Pvi bvi Rb` gube mæú` I e-MZ mæúŋ` i GK RiUj mgštqi cŋqvRb nq Ges Ab` th tKvb AvbŋmbK cŋZŋtbi gZB Gmŋei KvŋVŋgv ueb`im, e'e-vcbvi I ubŋ`Rbv mæúŋKŋ KvR mæúŋ`b KiŋZ nq| we`ij tqi gj-j`ŋ` nj gvbemæú` mŋŋ Kiv| Gw`K t_ŋK we`ij q mgvŋRi Ab`vb` msMVb t_ŋK `Zš;`enkö`gŋUŋ Ges Gi cġvmbK I e'e-vcbvi mæúŋKŋ mgm`vej I wfbæŋŋ KviY we`ij tqi j`ŋ, Dŋk` I mmeŋ KgrvU i e'e-vcbvi mŋŋ mgvŋRi mKj RbmvariY RiOZ| ikŋK, AwffveK, ivRbmZwe` Ges mKj tkŋvi kŋ I tckvRme gvbŋ i Avkv Avkv-Lv I `ŋ_P cŋZdj b NŋUŋtq we`ij q cwi Pvi bvi KiŋZ nq| GRb` ikŋv cġvmbK, ikŋK, MŋelK cŋŋ mKŋj iB cġvmb e'e-vcbvi wefwbæZĒ; I avi Yv mæúŋKŋ qmKenvj _vKv cŋqvRb| wefwbæZĒ; mgšŋ I mŋŋkŋ Y wbfŋ avi Yvi Avŋj vŋK Zuiv we`ij tqi A_ŋwZK, ivRŋwZK, mvgvRK I gŋvŋAvmbK wbgvgKmgŋ chŋŋ vPbv Kiŋeb Ges mŋ_R I MŋZkŋ cġvmb e'e-vcbvi `ŋ_Gme wbgvgK A_ŋYŋte mSMVZ KiŋZ mŋŋg nŋeb|

msMVb I e'e-vcbvi mæúŋKŋ DbZ` t`kmgŋŋ cŋŋ cŋŋqwmK Mŋel Yv I tj Lvŋ wL nŋŋŋQ| Gme Mŋel Yv I wbeŋŋi avi YvMZ wfwŋ cŋvbZ wZbŋU ZvŋĒK gj-avi vi tKvb bvi tKvb GKŋU i Mŋŋŋi tŋw_Z iŋŋŋQ| Gme ZvŋĒK gj-avi vŋK e'e-vcbvi mŋŋŋZ` (K) wPivqZ msMVb ZĒ; (Classical Organisation Theory), (L) mvgvRK msMVb ZĒ; (Social System Theory) Ges Dŋgŋ` msMVb ZĒ; (Open System Theory) wŋŋŋŋ AwfŋZ Kiv nŋŋŋQ| KLb KLb G_ŋj vŋK School of Thought ev Tradition wŋŋŋŋ AwfŋZ Kiv nŋŋŋQ| gj-Z Gme ZĒ; tKvb msMVb wKfvŋe KvR Kŋi ev wKfvŋe KvR Kiv DŋPZ ŋm mæúŋKŋ e`vL`v cŋvb Kiv nŋŋŋQ| AŋbK mgvŋj vPK ZĒ; ŋj vŋK Holistic eŋŋ weŋPbv KŋiŋQb| KviY G_ŋj v e`vcK we`Z. `ŋvŋŋŋ i e`vL`v cŋvb Kŋi Ges mŋSMVbK Nŋvvej i ŋgweb`ŋŋ HKmŋ I AŋŋbŋZ thŋv`KZv cŋkŋ Kŋi | e`w` ci`ŋŋi cŋZ tKb AvKó.nq Ges GKmŋ`_vŋK, wKfvŋe e`w` `úó ev A`úó j`ŋ` ARŋbi Rb` Kg ev teik thŋ` cŋPŋvq wŋŋŋRZ nq Gme mæúŋKŋ ZĒ; ŋj v Aek` wfbæ wfbæ Abŋv ev Assumption Gi Dci cŋZwŋZ| GB BDŋŋŋ ZĒ; ŋj v mæúŋKŋ wŋŋŋ wZbŋU cŋv Dc`vcb Kiv nŋŋŋQ|

cŋv- 1: wPivqZ msMVb ZĒ;
 cŋv- 2: mvgvRK msMVb ZĒ;
 cŋv- 3: Dŋgŋ` wŋŋŋ g ZĒ;

Միջնադարից հետո Երևանում 1930 թվականին հիմնադրվել է Հայկական համալսարանը՝ որտեղ սովորել են բազմաթիվ հայտնի գիտնականներ, արվեստագետներ, ասպետներ և պրոֆեսորներ։ Երևանի համալսարանը հիմնադրվել է 1930 թվականին և այժմ համալսարանը հասնում է իր 90-ամյակին։ Երևանի համալսարանը հիմնադրվել է 1930 թվականին և այժմ համալսարանը հասնում է իր 90-ամյակին։

Միջնադարից հետո

Երևանի համալսարանը հիմնադրվել է 1930 թվականին և այժմ համալսարանը հասնում է իր 90-ամյակին։

Միջնադարից հետո

Երևանի համալսարանը

- | | |
|---|--|
| 1. Հայաստանի Հանրապետության Հանրային կրթության նախարարություն | 1. Օրվա Դոկտրինա ՀՀ-ի և յուրաքանչյուր հայտնի Դոկտրինա ՀՀ-ի մեջ |
| 2. Կրթության նախարարություն | 2. Երևանի համալսարանը հիմնադրվել է 1930 թվականին և այժմ համալսարանը հասնում է իր 90-ամյակին։ |
| 3. Դոկտրինա (Երևանի համալսարան) | 3. Երևանի համալսարանը հիմնադրվել է 1930 թվականին և այժմ համալսարանը հասնում է իր 90-ամյակին։ |
| 4. Երևանի համալսարանի կրթության նախարարություն | 4. ՀՀ-ի կրթության նախարարությունը հիմնադրվել է 1930 թվականին և այժմ համալսարանը հասնում է իր 90-ամյակին։ |
| 5. Կրթության նախարարություն | 5. Երևանի համալսարանը հիմնադրվել է 1930 թվականին և այժմ համալսարանը հասնում է իր 90-ամյակին։ |
| 6. ՀՀ-ի կրթության նախարարություն | 6. ՀՀ-ի կրթության նախարարությունը հիմնադրվել է 1930 թվականին և այժմ համալսարանը հասնում է իր 90-ամյակին։ |

- 7. KZŹj; k•Lj (Chain of 7. cāvb ukŷŷKi ubKU hvlqvi cte©
Command) gvb`Ki Y| ukŷŷKiv Aek`B mnKvix cāvb
ukŷŷKi mvt_ K_v ej te|
- 8. AvPi Y wewa cŷqb| 8. ukŷŷKi n`vŪeŷ: ŪmKj ukŷŷK
mKvj 8:00 Uvi gta` -ŷj Avmteb
Ges weKvj 3:30 Uv chŷl -ŷj
_vKteb| Kvk iia Kivi cte©Qvŷŷi
Assembly tZ mKj ukŷŷK Dcw`Z
_vKteb...|Ū
- 9. Kgŷ`i gta` k•Lj v cŷZŷvKi Y| 9. Qvŷŷiv -ŷji ubqg bmvZ Ges
m`vPiŷYi Av`k© tgtb Pj te|
ukŷŷKMY tckvi Av`k©mgŷŷZ ivLteb
Ges ukŷŷv Awa`Bŷii ubt`R tgtb
Pj teb|
- 10. Kvi Mix Ávb I `ŷZvi wfvŷŷZ 10. ubtqvŷMi Rb` weGW/GgGW
ubtqvM cŷvb| Ges/A_ev ukŷŷK wntmte AwfÁZv
_vKtZ nte|
- 11. KvR m`úv`ŷbi Rb` GKwU mteŷŷg 11. MwYZ, weÁvb, BwZnm BZ`w`
Dciq ubaŷŷ Y| ukŷŷv vŷbi Rb` mteŷŷg c×wZ ev
Dciq ubaŷŷYi j ŷŷŷ` ubi ew`QbaMteI Yv
cwi Pvj bvKi Y|



cv#VvEi gj`vqb: 1

A) eú ubePbx c#æ

m#WK DËi ub#`Rgj-K A¶i#U#K eËv#qZ Kiab | (D`vniY: Avcbri ube#PZ DËi#U K ntj G#K **(K)** eËv#qZ Kiab)

1. #PivqZ Zv#E#K#M#Yi #bKU tKvb #elqu# #bQK AcPq etj g#b ntq#Qj ?
 - K. c#h#y#i `#Z c#h#i
 - L. e`e`vcbv c#x#Zi A`¶jZv
 - M. e`e`vcbv i#x#Zi m#t_ c#h#y#i msNvZ
 - N. Drcv`b tK#`#tj vi mgm`vej x |

2. #PivqZ Zv#E#K#M#Yi g#Z msMV#b Kg#e#v#n m#j# Ges m#e#P `¶jZv AR# KLb m#e n#e?
 - K. #e#k#l#Á #b#t#q#t#Mi gva`tg
 - L. Kg#i`i `j #efi#t#Mi gva`tg
 - M. #e#l#-#e#ar#b c#l#q#t#bi gva`tg
 - N. h#y#m#s#Z Kiv#t#gv I Kiv#e#x#Zi gva`tg |

3. ¶jgZv tKv_vq b`iK#i#Z n#e?
 - K. #e#k#l#Á Kg# Dci
 - L. `¶j Kg# Dci
 - M. KZ#j;k#L#t#j i k#l#e#t`i Dci
 - N. Kg#i`i `j #efi#M_#t#j#vi Dci |

Av) ms#¶j#B DËi c#æ

1. tKvb t#e#¶j#v#c#t#U #PivqZ Zv#E#K#M#Y Z#t`i `#f#w#Z Z#j a#t#b?
2. #PivqZ msMV#b ZË#K m#e#R#b#b `e#Á#v#b#K ZË#i#n#t#m#e Av#f#v#Z Kivi `c#t#¶j h#y# Kx?
3. #PivqZ ZË#A#b#y#t#i `¶jZv e#x#i Rb` #K #K Kiv c#l#q#v#Rb?
4. #PivqZ Z#t#Ë#i Av#K#I#¶ tKb n#m c#v#q?



m#WK DËi

A) 1 | L, 2 | N, 3 | M |

cW 2

mıgıwRK msMVb ZĚj

Dřĩk

GB cıW řkřĩ Aırcıb—

- mıgıwRK msMVb ZĚj Dřĩk cıUfıg Dřj Ľ KıtZ cıřeb;
- mıgıwRK msMVb ZřĚj `eıřkó` řjı eYřv KıtZ cıřeb;
- ĩe`ıj řq mıgıwRK msMVb ĩKfıře KıR Křĩ Zı eYřv KıtZ cıřeb Ges
- mıgıwRK msMVb ZĚj ĩ PıvqZ msMVb ZřĚj gřa` cı_ř` ĩbıřcY KıtZ cıřeb|

fıgKı

ıPıvqZ msMVb ZřĚj křgK ev KgřK ĩbQK GKıı e`ı Zj` gřb Kıv nq, AvgjıZıřK hřřj řm GKıı Ask gıř| G ZřĚj křgKř`ı e`ıřZı, `Zı ĩ AvřeM AbıřıZřK Dřcřıv Kıv nq Ges křıeřıRb, ĩeřkıřqY ĩ KZř; k;Lřj ĩ ĩřıĚřZ Drcı`řbı řřřř mřeřP `řřZı ARřbı Dci `ıāZı Avřıvc Kıv nq| G mKj řııı KřıřYB e`e`ıřcřı řřřř AvPııYK ĩeAvřbı ĩřıĚřZ gıbe mıúřKř ĩelqıı ĩeřePbı K_v AřbřKı gřb Dı`Z nq| Elton Mayo ĩ Zıı mıKgřMY KZř. 1920 Gı `křK cıı Pııj Z n_Y`mgıřıv (Hawthorne Studies) Gřřřřř AMřx řıgKı cıj b Křı|

n_Y`mgıřıv cřııbZ nq řh Drcı`řbı řřřř křgKř`ı řcřYı mıřı Rb` gRıř Ges KřřRı kZřejx GKgıř gE` ĩbqıřK bq| křgKř`ı ĩbKU Gme `ıāZcY`ıeřeıPZ nřj ĩ Gř`ı `ıř ĩřZıq`ıřb| `ıāZcY`ıelq ĩnřmře cř_g`ıřb ĩřqřQ mıgıwRK mıúřKř ĩelqıı ĩvřK Mayo-Gı K_vq ejv ĩvq "A method of living in a social relationship". křgKř`ı `řj ĩ Af`řřı ĩeıvRgıv mıgıwRK-gřbıřeAvıřK Drcı`ıbmgıř Drcı` b cřııřıřK cřřZ cıı gıřY ĩbqřř Křı, GB `ıāZcY`ıAııe`ııı ıPıvqZ e`e`ıřcřı ZřĚj AřbK řgřıj K a`ıv aıvYřK Přgıı Křı ř`q Ges GKıı bZb msMVb ZřĚj mřcıvZ Křı| cřııb ĩ e`e`ıřcřı mıııřZ` GB bZb ıPřřıııřıřK mıgıwRK msMVb ZĚj (Social Systems Theory) eřj AıřıııZ Kıv nq| KLřbı KLřbı G ZĚřK gıbıeK mıúřK`ZĚj (Human Relations Theory) eřj ĩ AıřıııZ Kıv nq|

mıgıwRK msMVb ZřĚj `eıřkó

mıgıwRK msMVb ZřĚj křgK ev Kgř`ı řK msMVřbı mř`_ GKıvZıv řeřřa Dřıy Kıvı Dci `ıāZı Avřıvc Kıv nq| GLıřb křgKıv ĩbRř`ı msMVřbı Ask ĩnřmře gřb Křı Ges msMVřbı j řř` ARřb ĩbřRř`ı Ae`ıv ĩvLřZ Meřeva Křı| GRb` msMVřbı Dřĩk`ıeıřj Aek`B Ggb nřq`ıřK řh e`e`ıřcřı MıZ cřKııZı Dci křgKř`ı cY`Av`ıı mıř nq Ges Zřř`ı gřa` Ggb ĩekřım RıMř nq řh Dřĩk` `řjıı Rb` KıR Křı Zıř`ı cřZ`řKB mřj cıře ĩ mřřıjřř KıtZ cıře| gıbıeK mıúřKř Dci cřZıřZ GB gZev` řh `ıřřıřřřK

DtaZtj ati Zv nj GB th, mtePP cwi ZB.msmVbB nj metPtq `ᚦ msmVb| msmVtbi AbivgmbK `j ev Dc`j ,tjvtK `gb ev webó bv Kti G,tjvi tgšij K Pwin`v ,tjvi ᚦKwZ.† l qv nq Ges msmVtbi Dfík`i mt_ G,tjvi mvgAm` mvab Kiv nq| GKvR Kivi Rb` gvbweK m`úK`KvhPtg `ᚦ mgyvi fvBRviMYtK `vqZj c0vb Kiv nq| gvbweK m`úK`ZtEj m` "Qv l mnthvMZvi wfvEzZ e`e`vcK l klgKt`i gta` 0` ev tf`vtf` ubimtbi Rb` e`e`vcvri tᚦtᚦ MYZvšK i xvZbvZ Abkxj b Ges klgKt`i AskM0tY Kg`cwi tek m`p l D>gᚦ thvMvthvM c0Z0vKiYi Dci metkl tRvi c0vb Kiv nq|

ve`vj q l mvgwRK msmVb

Ab` th tKvb msmVtbi gZB ve`vj tq l AMwYZ mvgwRK wmt÷tgi Aw`Zj itqtQ| Gme wmt÷tgi tKvb tKvbU AbivgmbK thgb weÁvb wkᚦKt`i Kve, Avevi tKvb tKvbU AbivgmbK thgb Pv cvtbi AvCv-Pμ| G,tjv ᚦ`vqx ntZ cvti, Avevi `xN`vqx ntZ cvti | mvgwRK wmt÷g ,tjvtK KZK ,tjv mvgwRK-gtbr%ÁvbK Dcv`vb thgb weklm, Acti i vbKU c0`vkv, tc0Yv, gtbrvve BZ`w` AU0 e0tb Ave x i vL|

mvgwRK wmt÷tgi Aw`Zj Rb` Kgcᚦᚦ `ᚦ ev ZtZmaK e`w3i c0qvRb nq hv`i gta` wq_w`ᚦv NtU Ges hv`i tgvUvgnj GKB iKg j ᚦ` l AvPiwYK aviv _vK| mvgwRK wmt÷tgi c0vb `ewkó` ,tjv nj : (1) e0Zi, (2) wq_w`ᚦv, (3) j ᚦ`, (4) AvPiwYK aviv l c`vUvb`Ges (5) mgq ev tgqv`Kvj | Gme `ewkó` wetePbv Kti tKvb evm÷`vU evfmi Rb` Atcᚦᚦgib 8 Rb e`w3tK GKU mvgwRK wmt÷g etj AwfwnZ Kiv hvte Kx? GiUtK Aek`B mvgwRK wmt÷g ejv hvte bv, KviY Gt`i gta` tKvb wq_w`ᚦv nqv Ges Gt`i GKĪ Ae`vbl tKvb tgqv`x NUbv bq| Zviv vbQK KtqKRb e`w3i GKU mgytek gvĪ hviv tKvb GKK j tᚦ`i tc0ᚦtZ Ave x bq| Ggubfvte 10 Rb QvĪ hviv c0g w`b evfm Kti ᚦᚦ hv`Q Zviv l tKvb mvgwRK wmt÷g Mto tZvtj bv| wKš`KtqKevi GKĪ evfm hvĪvi ci Zvt`i gta` e0tZj bvbv aviv Mto DVte Ges GKmgq ᚦ`vveZB Zviv mvgwRK wmt÷tgi e0tb Ave x ntq hvte|

ve`vj tq AmsL` mvgwRK wmt÷g _vKtZ cvti GK_v AvtMB ejv ntqtQ| ve`vj tqi mvgwRK wmt÷gtK Ggb GKU Dc-wmt÷g (Sub System) wmtte wetePbv Kiv thtZ cvti hv Ab` Avi GKU Dcwmt÷tgi Ask Ges H epEi Dcwmt÷guU Avevi Z`tcᚦᚦv Avil epEi GKU Dcwmt÷tgi Ask| D`vniY wmtte ejv hvq, ᚦᚦ i `ᚦRb evsjv wkᚦK GKU Dc-wmt÷g Mto ZᚦtZ cvti hv nte fvlv wkᚦKt`i Dcwmt÷tgi GKU Ask, hv nte gvbweK wfvM Dcwmt÷tgi GKU Ask hv nte ᚦᚦ i Dcwmt÷tgi GKU Ask, hv nte Awa`Bti i Dcwmt÷tgi GKU Ask| GB Dcwmt÷g ,tjvi th tKvb GKU KiᚦRi aviv ev cKwZ. eᚦtZ ntj GiU AvtMi l cti i Dcwmt÷g m`úK`P eᚦtZ nte| D`vniY`f c D`P gva`ngK ᚦti i BvZvnm wfvvMi NUbvej eᚦtZ ntj ve`vj q KZR.H wfvvMi Dci AvtvcZ wvab0la l Pwin`v A_ev wkᚦKt`i wfvb0tj i Pwin`v l c0`vkv tKgb Zv Aek`B tevSv `iKvi| ve`vj tqi c0vmKMY AtbK mgq wkᚦKt`i tKvb tKvb KvRtK AwkᚦKmjrf KvR etj gtb Ktib| wkᚦKivi KLtbr KLtbr QvĪt`i Athšw3K l k;Lj v cwi cšx AvPiYi K_v Dᚦj L Ktib| wKš`msMvtK GKU wfvb0c0ᚦtZ ntZ Aetj vKb Kiᚦj Gme AvPiY nqZ ht_ó thšw3K, k;Lj vcY`Ges wkᚦKt`i tejvq

Aek`B uk`Kmjyf etj cZxqgvb nte| GLvfb cv`R` nj GB Kvi`Y th e`wZμgag® AvPiY` tji gj itq`Q tKvb GKwU mvgwRK wmt`÷g, c`jiv msMVbuU bq| we`'vj tqi weifbaDrm ntZ th me bvbv ai`tbi mvsMvubK kw`³i D`M`e nq tm` tji mWVKfite Dcj`wä Ki`Z bv cvitj c`kvm`b nZvkvi mwó nq hv f`j mgm`vi t`j`i`f`j f`j mgvavb etq Avb`Z cvti |

ivPiqZ ZÉj I mvgwRK ZtÉj gta` cv`R`

ivPiqZ msMVb ZÉj I mvgwRK msMVb ZtÉj gta` A`tbK w`el`tq tg`šij K avi YvMZ cv`R` itq`Q| w`b`P Gme cv`R`i KtqKwU w` K Dc`vcb Kiv nj :

ivPiqZ ZÉj

mvgwRK ZÉj

1. Aa`b t`_tK DaZb c`μtg KZé` I `wqZi cvij Z nq|
2. `jgZv c`avb KgRZP ev w`b`f`xi w`bKU t`Kw`fZ`_v`K|
3. Avb`g`mbK j`j`_v`K hv t`_tK w`efba Kv`Ri w`b`Rbv Av`tm|
4. thw`v`thvM c`Zw`Z gva`g AbyiY Kti Ptj |
5. c`Z`o`v`bi w`bqgKvby `šiv Drcv`b e`e`v (w`kLb-tkLv`bv Kvh`eg) w`bq`šZ nq|
6. DaY`Zbiv Aa`b`i Pw`j t`q tbq|
7. `š`š ev msNvZ AKvh`Ri hv w`bgj Kiv c`šqvRb etj g`tb Kiv nq|
8. Avw`R Pw`v`v Aa`b`i gta` tc`š Yv mwó Kti |
9. gvby `fveZ KvR Ki`Z Prq bv, mZivs w`bweo cwi`k`š (Supervision) Ri`šix|
10. c`šqvRbxq `jZv I `bcY`_vKtj GKRBtK AvtiKRtbi `v`tb Kv`R w`b`tqvM Kiv hvq|

1. KZé` I `wqZi cvj tbi t`j`i`f`j Avb`g`mbK, w`mt`÷gi evBti w`efba mvgwRK, ivR`w`ZK `j`exZv KvR Kti |
2. `jgZv w`efba`j ev `j`tMw`oi Kv`Q Qov`bv`_v`K|
3. Avb`g`mbK Ges Avb`g`mbK j`j`i`i gta` c`šqkB msNvZ nq Avb`g`mbK j`j`i`i Rb` bvbvgyx w`b`Rbv Av`tm|
4. thw`v`thvM msukó `j mg`tni `v`š`AbyiY Kti Ptj |
5. w`efba`tji Avb`g`mbK ev Av`k`g`vb `šiv Drcv`b e`e`v (w`kLb-tkLv`bv Kvh`eg) w`bq`šZ nq|
6. Aa`biv c`šqkB DaY`Zb`i Pw`j t`q tbq|
7. `š`š ev msNvZ Kv`th`c`thvM (MVbgj K) Ges Acw`nvh`etj g`tb Kiv nq|
8. Avw`R w`elq Qvov Ab`v`b` w`elq Aa`b`i gta` tc`š Yv mwó Kti |
9. KvR Ki`Z bv PvlqvUv gvby`i Pwi`t`i Aš`b`h`Z `eukó` bq, GilU Zvi AvRZ `eukó` (Learned Behaviour) |
10. c`Z`K e`w`³ Kg`j`i`f`j Abb` mvgwRK I g`tbv`w`Áv`bK `eukó` w`b`tq Av`tm Ges w`bR w`bR Ae`v`b ev f`jgKv t`_tK Drcv`b e`e`v`K c`f`v`eZ Kti |



cv#VĒi gj`vqb: 2

A) eū ubePbx cĕæ

m#WK DĒi ūb#`Rgj-K Aŋi#U#K eĒv#qZ Kiab| (D`vniY: Avcbvi ūbe#PZ DĒi#U K ntj G#K (K) eĒv#qZ Kiab)

1. ūPivqZ Z#Ēj tKv#U#i Dci , i#Zj Av#ivc Kiv nq?
 K. e`#Zj
 L. Av#eM Ab#v#Z
 M. Drcv`b
 N. gvbe m#úK#
2. nLY#ngx#ŋv Ab#v#i k#gK#`i t#ŋYv m#i#i Rb` me#P#q , i#ZcY#e#lq tKv#U#?
 K. KZ#j.k#Lj
 L. m#gv#RK m#úK#
 M. Kv#Ri kZ#ej x
 N. gRjx|
3. m#gv#RK msMV#bi t#ŋ#ŋ tKv#U# c#h#vR` bq?
 K. msMV#b Ab#v#ŋ#bK `tj i Ae`vb
 L. k#gK#`i AskM#ŋY
 M. msMV#bi m#t_ k#gK#`i GKvZ#v#eva
 N. e`e`vc#vi M#Z c#k#Z.m#ú#K#k#gK#`i Abv`v|

Av) ms#ŋ#B DĒi cĕæ

1. m#gv#RK ZĒj D#m#ei t#ŋ#ŋ n_Y#ngx#ŋvi f#v#Kv Kx?
2. m#gv#RK msMVb Z#Ēj K#qK#U# `e#k#ó` D#j#L Kiab|
3. e`e`vcK I k#gK#`i g#t#`ŋ` ūbim#bi Rb` ūK#mi Dci tRvi t`lqv nq?
4. D`vniYmn m#gv#RK ūm#t#`gi `e#k#ó` , tjv D#j#L Kiab|
5. ūe`vj#q ūK ai#bi m#gv#RK ūm#t#`g ūeivR K#i Zvi GK#U# eY#v#v`b|



m#WK DĒi

A) 1| M, 2| L, 3| N|

cW 3

Dəgʷ ɪntəg ZĖj

Dʹik

GB cW tkʹl Avɪɔb—

- Dəgʷ ɪntəg ZĖj ej tZ ɪK eʃvq Zv eˈvLˈv Ki tZ cvi tɛb;
- Dəgʷ I ex ɪntəg tgi gʹaˈ cɪ_ʁˈ ɪbɪfɔY Ki tZ cvi tɛb Ges
- ɪPivqZ ZĖj I Dəgʷ ɪntəg ZĖj avɪ YmZ cɪ_ʁˈ Dʹjɫ Ki tZ cvi tɛb |

fɪgKv

1960 Gi `kʹk bZb cħɪʃ ɪbɸ mgvʹR Dəgʷ ɪntəg ZĖj D˩e nq | ɪPivqZ I mɪgʷɪRK ZĖj ɪntəg msMVBʹK Zvi Pɪcɪtʹki cwi tɛk nʹZ ɪeʷQbæGKɪU ex ɪntəg (Closed System) ɪntəg Kɪbɪ Kivi cħYzv tˈLˈv hvq | Dəgʷ ɪntəg ZĖj msMVBʹK GK ˈQ ci ˈúi mˈúKħɪʃ A½ ɪntəg Kɪbɪ Kiv nq thˈtjv cwi tɛtʹki mʹ_ GKɪU Rɪeʃcħɪxi gZ ɪɪqv-cħZɪɪqv Kʹi | A_ʁˈ Dəgʷ ɪntəg ZĖj cwi tɛtʹki mʹ_ Nɪbɔfɪtɛ mˈúɪKʃ Ges cwi tɛk ɪbtqB Gi KvRKvi evi | GLvʹb msMVB cwi tɛk nʹZ gɪbe I eˈMZ mˈúKˆ gjˈtɛva, mgvʹRi Avkv-AvKˈLv, Pɪmˈv BZˈv thvMvb (Input) ɪntəg cvq; GˈtjvʹK Drcvˈb cħɪqvɪ (thgb- tkħY ɪkħY Kvħɸg) gvaˈtg ɪfɔvʃħi Z Kʹi Ges Drcvˈ Z cYˈ (thgb ɪkħYʹZ eˈvʃ, bZb Avb, bZb gjˈtɛva) cħɪvq eˈemv, ɪkħYv, Mq I tmevgj-K cħZɔvʹb Z_v cwi tɛtʹk ɪeZiY ev ɪBɪb Kʹi | cħZɔvʹb G KvʹRi Rbˈ mgvʹRi ɪbKU t_ʹK Av_ʁˈ mʹthvMZvi gaˈ ɪtq cħZˈvb cvq hv ZvʹK ɪUʹK _vKʹZ I Dbqʹtbi cʹ_Pj tZ mɪvqZv Kʹi | GfɪtɛB cħZɔvʹbi KvR PɪɪvKʹi Pj tZ _vʹK |

ɪeˈvʹj q I Dəgʷ ɪntəg ZĖj

tKvb cħZɔvʹbB mɪWK Aˉcħɪvɪvʹ Dəgʷ ev ex bq | GKɪU cħɪvɪvʹ ex ɪntəg Zvi Drcvˈb eˈeˈvi Rbˈ tKvb gɪbe ev eˈMZ mˈúˈ thvMvb ɪntəg cvtɛ bv Ges cwi tɛtʹk tKvb Drcvˈ Z cYˈI ɪeZiY Ki tZ cvi tɛ bv | AZGe, G aɪtʹbi ɪntəg tgi tKvb AvˈZ | _vKʹZ cvtɪ bv | cħYvʃħi cħɪvɪvʹ Dəgʷ ɪntəg tKvb ɪbeʃɸbx ev evQvB cħɪqv _vKʹtɛ bv etj GɪWi Kvħˈcwi Pvj bv AZˈɪaK Zˈ Ges AcħqvRbxq KvPvgj ʃvɪv fɪvɪmʃħnʹtɛ | AZGe tKvb cħZɔvʹb cħɪvɪvʹ Dəgʷ bv ex Gfɪtɛ ɪPʃħ bv Kʹi cħZɔvʹbɪU tKvb ɪetʹkl ɪmˈvʃħ ev Pɪtci gʹɫ ɪK cwi gʹtʹY Dəgʷ ev ex Zv ɪetɛPbv KivB Avak ħɪʃmˈʃZ | DˈvniYˈtʹc ejv hvq, GKɪU ˈʃˈ nqZ ɪkħYvɸg mˈúɪKʃ ɪetʹq AvfʹvKʹi cɪvgkˆ MħtʹYi tejvq ħt_ó Dəgʷ nʹZ cvtɪ | Avevi Qvʹtʹi k;Ljv ɪelqK ɪbqgKvbʹtʹbi tejvq cɪvgkˆMħtʹY ʃˈexˆ nʹZ cvtɪ | AZGe bɪbv aɪtʹbi ɪetʹq ɪmˈvʃħ MħtʹYi cħkæGKɪU ˈʃˈ ɪeʷfɔægvʹvq Dəgʷ ev ex nʹZ cvtɪ | Zħbvʹgj-K ɪePɪtʹi tKvb tKvb cħZɔvʹb ev msMVBʹK ʃˈDəgʷ-exˆ gvʹv tˈtʹj i tKvb GKɪʹK GKUzɛɪk SʹK coʹtZ tˈLˈv hvq | Avʹvʹ i tˈtʹki mɪKvix ˈʃˈtjv AʹbKUv ex ɪntəg tgi Abɪfɔ | GˈtjvʹK Qvʹtʹi Rbˈ Abˈ cħZɔvʹbi mʹ_ cħZthvMZv Ki tZ nq bv, ɪUʹK _vKʹi Rbˈ tKvb msMʹgɪ Ki tZ nq bv | Gˈtjvɪ

Aw~Zi GKIKg ubwōZB ejv hvq| G,tjvi A_ŕqbl Kg®ŕZv ev mvdŕj`i mŕ_ Nubōfŕte m̄úKZ bq| A_ŕ G,tjvi Qvŕiv cieZŕZ tKvb wekŕe`ij q ev Kŕj tR fŕZ® nŕZ cvj ŕKbv, bŕK teKvi Ae~ŕq cŕ_ cŕ_ Nŕj teovj ZŕtZ ŕKQyAvŕm hvq bv| G,tjv eQi eQi tgvUvgnŕ GKB iKg Aw_ŕ eivŕ ev thvMvb tctq hvŕ"Q| Ab~ŕ tK teŕki fŕM temiKvix cŕZōvb I ~ž nŕ"Q`eŕkó"MZfŕte D:gyŕ cKŕZi| G,tjvi Aw~Zi ubwōZ bq, ŕŕK _vKvi Rb" G,tjvŕK msMŕg KiŕZ nq| G,tjv ŕbŕŕŕ`i cŕŕqvRb Abŕvqŕ MŕnK ev Qvŕ ŕbeŕPb Kŕi| Gŕ`i A_ŕqbl I mnŕthvMZv ŕbŕP Kŕi Kg®ŕZv I Drcv`ŕbi ŕ Yv,ŕYi Dci| G,tjv m̄ú` AvniY I ŕecYŕbi Rb" ci`úi cŕZŕthvMZvq ŕj B nq Ges KLŕbv KLŕbv G,tjvi Aw~Zi ŕecbœev ŕej xb nq| ~fveZB teŕP _vKvi Rb" Gme cŕZōvbŕK cŕiŕeŕki cŕi eZŕKj Pŕn`vi mŕ_ mgšŕ Kŕi PjŕZ nq|

ŕPivqZ ZĚj I D:gyŕ ZŕĚj gŕa" cv_ŕ"

ŕPivqZ ZĚj Ges D:gyŕ ŕmŕ÷g ZŕĚj gŕa" avi YvMZ cv_ŕ" ,tjv ŕbŕP Dŕj L Kiv nj :

- | ŕPivqZ ZĚj | D:gy³ ŕmŕ÷g ZĚj |
|---|---|
| 1. msMVŕbi `eŕkó" nj Aa~b t_ŕK DaŕZb c`µŕg KZ® I `ŕqZj cvj b Kiv nq | 1. msMVŕbi `eŕkó" nj Dc-ŕmŕ÷g,tjvi Af`ŕŕi Ges ci`úŕii gŕa" bŕbv aiŕbi NUbv Pŕµi mŕŕthvM KvR Kŕi |
| 2. ŕŕgZv cŕvb KgŕZP ev ŕbeŕŕxi ŕbKU tKŕ`fZ _ŕŕK | 2. ŕŕgZv Dcŕmŕ÷g,tjvi gŕa" Qovŕbv _ŕŕK |
| 3. AvbŕmbK j ŕŕ" t_ŕK NUbv ev KvŕRi ŕ K ŕbŕ`Rbv Avŕm | 3. cŕiŕeŕki Pŕn`v I cŕŕqvRb t_ŕK NUbv ev KvŕRi ŕ K ŕbŕ`Rbv Avŕm |
| 4. thvMŕthvM cŕZŕōZ gŕa"g Abŕvqŕ Pŕj | 4. thvMŕthvM mgMŕmŕ÷g`ge`vcx Pŕj hvŕZ Dc ŕmŕ÷g,tjvi KŕRi mgšŕ Kiv hvq Ges cŕiŕeŕki mŕ_ mŕŕthvM mŕab Kiv hvq |
| 5. msMVŕbi ŕbqgKvbŕbi ŕviv Drcv`b e`e`vi Dci ŕbqšŕ cŕZōv Kiv nq | 5. Dcŕmŕ÷g,tjvi mŕ_ cŕiŕeŕki mŕ_ŕ mŕŕthvM mŕaŕbi gŕa"ŕg Drcv`b e`e`vi Dci ŕbqšŕ cŕZŕōZ nq |
| 6. ŕŕ msMVŕbi Rb" ŕŕZKi hv ŕbgj`Kiv cŕŕqvRb | 6. ŕŕ Acŕiŕnŕh® hvi mŕŕŕkŕj e`e`vcbv msMVŕb AbŕKj cŕi eZŕ Avbqŕb mŕvqK |
| 7. tKvb KvR m̄úv`ŕbi GKŕUB gvŕ mŕeŕĚg cšŕ iŕŕŕQ | 7. tKvb KvR m̄úv`ŕbi Rb" mgfŕte mŕšŕŕ RbK ŕeŕfbœcšŕ iŕŕŕQ |
| 8. msMVŕbi ŕKfŕte KvR Kiv DŕPZ ŕm m̄úŕK®Avŕj vKcvZ Kŕi | 8. msMVb ŕKfŕte KvR KiŕQ ŕm m̄úŕK® Avŕj vKcvZ Kŕi |
| 9. e× Ges cŕiŕeŕk nŕZ ŕeŕŕQbŕ | 9. D:gy ³ Ges Input-Output cŕŕqvŕi gŕa" ŕŕŕ cŕiŕeŕki mŕ_ ŕŕqv Kŕi |
| 10. m̄úK®GKB iKg Ae~ŕq ev ~ŕei Ae~ŕq _ŕŕK | 10. m̄úŕK®MŕZgqZv _ŕŕK |
| 11. Pŕvš. KZŕj. I `ŕqZj gL" KgŕZŕ nŕŕZ _ŕŕK | 11. gL" KgŕZŕK Ggb AŕbK NUbvi KZŕj. I `ŕqZj ŕbŕZ nq hv Zvi ŕbŕRi mŕ bq Ges ŕbqšŕYI bq |



cv#VĚi gj`iqb: 3

A) eú ubePbx cĕæ

m#WK DĚi ubt`Rgj-K Aŋiu#K eĚvqZ Kiab | (D`vniY: Avcbvi ubePZ DĚi#U K ntj GtK (K) eĚvqZ Kiab)

1. Dɔgʒ imt÷g ZtĚj tKvbu#K GK„Q ci`úi m#úKŋʒ A½ imt#te Kíbv Kiv nq?
 K. Rxeš#cŇvtK
 L. cvi#tek#K
 M. #uqv cĚZ#uqv#K
 N. msMvb#K |
2. c#jvcv# Dɔgʒ imt÷tg msMv#bi tŋ#tĚ tKvbu N#U?
 K. cvi#tek ntZ thvMvb cvq bv
 L. AZ`v#K Z`„Ňviv fvi#vš`nq
 M. Drcv`Z cY` cvi#tek #eZiY Ki#Z cvi# bv
 N. ubePbx ev evQvB c#uqv KvR K#i |
3. Avgv#`i t`#ki miKvvi `#`_tjv ex cĕ#Zi, KvY G`_tjv-
 K. ubt#t`i cŇqvRb Ab#vqx QvĚ ubePb ev f#Z#K#i
 L. Ab` `#`_tjvi m#_ cĚZthvMZv K#i
 M. cvi#tek#i Pvn`vi m#_ mgšŇ Kiv#K D#cŋv K#i
 N. Av`#Z#i Rb`#bi š#i msMŇg K#i |

Av) ms#ŋ#B DĚi cĕæ

1. msMvb cvi#tek#i m#_ #Kfiv#e P#uvKv#i KvR K#i?
2. tKvb cĚZŇvbB c#jvcv# Dɔgʒ ev ex bq- e`vL`v Kiab |
3. Avgv#`i t`#ki temiKvvi `#`_tjv Dɔgʒ bv ex cĕ#Zi? e`vL`v Kiab |



m#WK DĚi

A) 1 | N, 2 | L, 3 | M |

ḡ Ae GW#Kkb

weawaeavb I c×wZ cŷvZ nq| Gi dtj msMVtbi KvRi avivevwnKZv, ḡwqZj Ges ceFvrm cŷvb wbuōZ Kiv hvq|

ḡbe^QKZv (Impersonal Relationship)

msMVtbi hveZxq KvR weawae× wbgg Kivby Ablyvqx cwi Pwvj Z nte, tKvb AvteM AbfŷvZ ev e^w3MZ cŷ, ms^vi GLvfb tKvb ḡiaZj cvte bv| KtVvi fite wbggk;Ljv cwi Z ntj Kg^ḡ i Dci wbgšŷ Z_v msMVtbi Kivhewj i Dci wbgšŷ h_vh_fite cŷZwōZ nte|

Kg^Qŷv (Expertise)

Avvj vZtšj Kg^ḡwbtqvM Kiv nq thvM^vZv, Kwimwi Ávb I ḡbctŷ^vi wfiÉtZ| tR^oZv Ges tgavi weŷePbvq c^vvbwZ Ges c^vi μgiblyvqx teZb cŷvb Kiv nq| KvRb cŷkŷŷi gva^ḡ Kg^ḡ i thvM^vZv I ḡŷv weKv^tki Dci ḡiaZj Av^tivc Kiv nq|

tftei gj-Z msMVtbi GKw AvbōmbK Kivv^tgv wbaŷŷi Dci ḡiaZj Av^tivc Ki^tŷb| Zu j ŷ^Q Ggb GKw Kivv^tgv wbaŷŷi Kiv hv thš^w3K wfiÉtZ w^všⁱ Mh^tŷi KvR^tK wL^ḡ I Zj wš^Z Ki^tZ mŷg nte| Avvj vZtšj cŷh^t½ tftei th e³e^v Dc^vcb Ki^tŷb Zv nj :

“The most efficient form of administrative organization, because experts with much experience are best qualified to make technically correct decisions and because disciplined performance governed by abstract rules and coordinated by authority hierarchy fosters a rational and consistent pursuit of organizational objectives.”

Avvj vZtšj gj^vq

iev^UgU^ḡ Avvj vZtšj ḡY eY^ḡ Ki^tZ th^tq D^tŷ^ḡ Ki^tŷb, “The chief merit of bureaucracy is its technical efficiency, with a premium placed on precision, speed, expert control, continuity, discretion and optimal returns of input.”

Avvj vZtšj mgv^tj vPbvq cŷqkB bvbv ai^tbi t^vi μwⁱ K^v D^tŷ^ḡ Kiv nq| A^tbtKi gtZ Avvj vZtšj e^w3 i g^ta^v fia^v I cimbf^ḡkij g^tbrfve M^to tZv^t| e^w3 Zvi e^w3Zj wemR^ḡ w^tq g^vbtq Pjvi b^wZ Aej^v b^t Ki^t| Avvj vZwš^k cŷvmb I e^vvc^vi K^tVvi wbgg I wea w^tl^tai hvZvK^tj e^w3 D^t^vM I mR^bkij Zv web^o nq| KZ^ḡ; GLvfb AmacZ^vgj-K Ges Agv^wieK nq, e^w3 i m^tg^vŷⁱ gZ bq h^tšj gZ Av^PiY Kiv nq etj Kg^ḡ i g^vtS we^tkl Ki^t Aa^v b Kg^ḡ i g^vtS nZ^vkv m^wo nq|



cvtVĒi gj`vqb: 1

A) eū ubePbx cĕæ

mĭWK DĒi ūbt`Rgj-K AŋiūUĕK eĔvĭqZ Kiab| (D`vniY: Avcbvi ūbePZ DĒiū K ntj GĕK (K) eĔvĭqZ Kiab)

1. Avgj vZtš;msMVĕbi KZĖ;ŭKfvĕte ūeb`ĭnq?
 K. GK „Q mvsMVĭbK bŭzi ūfĭĕtZ
 L. Dci t_tK ŭgvštq ūbtPi ūtK
 M. tgavi ūfĭĕtZ
 N. `ŋZv I ūtKlvqĕbi ūfĭĕtZ|

2. msvMĕbi `ŋZv ARĖ mæe nte ŭKfvĕte?
 K. mKj c`gvbŭgvbŭvqx ūeb`ĭKivi gva`tg
 L. thšw³K ūfĭĕtZ ūm×všĭMĕtYi gva`tg
 M. ūtKlvqb tŋĭ ūntmte Kgĕ`i ūbtqvM Kĕi
 N. Kĕvvi fvĕte ūbqg k;Lj v cij b Kĕi |

3. Kgĕ`i Reveŭ nxZvi Rb`tkvĭū cĕqvRb?
 K. msvMĕb `beĕ³KZv
 L. kĕgi ūefvRb
 M. ūbqg I ūeŭa ūeavb
 N. c`tmvcvb KvVtgv|

Av) msvŋB DĒi cĕæ

1. Avgj vZtš;msMVĕbi tkvb c`B ūbqšĕYi evBĕi _vtK bv, e`vL`v Kiab|
2. msvMĕb `beĕ³KZv ej tZ ŭK tevSvq? Gi dj v dj ŭK?
3. Avgj vZtšj ūei t× AvfthvM ŭK ŭK?



mĭWK DĒi

A) 1| L 2| M, 3| N|

cW 2

tdWwi K DBYtj v tUj i (1856-1915): ᄡeÁmbK e'e ᄡcbvi RbK

DtIk

GB cW tkfI Avcb—

- ᄡeÁmbK e'e ᄡcbv c×wZi ᄡófw½ Dtj L KiZ cvi teb;
- ᄡeÁmbK e'e ᄡcbvi bñZgvj v Dtj L KiZ cvi teb Ges
- ᄡeÁmbK e'e ᄡcbvi t'vI Áau Dtj L KiZ cvi teb|

fvgKv

tdWwi K DBYtj v tUj i (Frederick Winslow Taylor) nekjm KiZzb tfsZ weÁvtbi tŋtI thgb cŋkuzK wbgg ev mF AvtQ tZgwb KvtrI tŋtI cŋkuzK wbgg ev mF itqtQ| A_ŋ ᄡeÁmbK ᄡófw½tZ tKvb KvtrI cŋkuz chŋjvPbv Kti H KvRwU m'úv`tbi GKwU mteŋKó.c×wZ wbyŋ Kiv m'æ| tUjtii AvtM KgŋvB wbaŋY KiZ GKwU KvR m'úbæKivi Rb" KZ mgq jvMte Ges wK c×wZtZ Zv m'úbæKiv nte| tUj iB meŋg ᄡeÁmbK c×wZ cŋqvM Kti RvbZ Drmivx nb GKRB Kgŋ KZUKzkvR Kiv DiPZ| wZwb cŋg etj b, e'e ᄡcbvi ᄡwqZjnt"Q Kgŋ`i KvtrQ wK cŋvkv Kiv nt"Q tm m'útkZi`i Dct`k t`I qv Ges wKfvte Zviv KvR m'úv`b Kite tmwU wv`ŋ Kti t`I qv| GRb" B tUj itK ᄡeÁmbK e'e ᄡcbv c×wZi RbK ejv nq| (The Father of Scientific Management)

ᄡeÁmbK e'e ᄡcbvi bñZgvj v

tUj i 1911 mtb cŋvkZ Zui Mŋs The Principles of Scientific Management-G Zui gZvgZ e"3 Ktib| Zui gZvgZi Dtj LthvM" w K,tjvi msvŋŋBmvi Villers wbtgwe"iŋc Ztj atitQb:

1. mgq-mgxŋv bñZ (Time-study Principle)

GKwU KvtrI weŋfbæw K,tjv w"úbæKivi Rb" KZUKzmgŋqi cŋqvRb Zv cwigvc KiZ nte Ges GKRB Kkjx Kgŋ Kvŋm'úv`tbi Rb" cŋgZ mgqmxgv (Standard Time) mwKfvte wbjcy KiZ nte|

2. wcm-tiU bñZ (Piece-rate Principle)

cwi kŋgK nte Drcv`tbi AvbgwZK Ges cwi kŋgŋKi nvi wbfŋ Kite mgq-mgxŋv ŋv v wbyŋZ ÷ vUw"Gi Dci| GKRB KgŋK mteŋP`tjii th KvRwU tm KiZ mŋg nte tmwB w`tZ nte|

~ž Ae GW#Kkb

we#kIvqb KVR#K hvišK, GK#Ntq I AvKI#nY Kti tZvtj Ges Kg#`i gta" AZ#B.
tertai m#o Kti |

weifc mgvtj vPbv m#Ej GK_v Avgv#`i ~šitY ivL#Z nte th eÁmbK e'e`rcbv c#WZi
mvd#j`i A#bKUVB wbf# Kti e'e`rcK I Kg#`i #PŠr I `#ofw# cwi eZ#bi Dci | G
cwi eZ# mwaZ ntj A#bK mgvtj vPbvi Actbv`b nte etj g#b Kiv nq| hvB trvK, GUv
Ab`#Kiv#th, e'e`rcbv I cwi KÍbv m#ú#KZ Avgv#`i A#bK AvaybK firebvi wfi#Eg#j
i#q#Q tUj #i i Drcv`bk#j Zv e#x#i `#ofw#|



civVĚi gj`iqb: 2

A) eũ ubePbx cĕœ

mivK DĚi ubř`Rgj-K AřiuUřK eĚvıqZ Kiab| (D`vniY: Avcbvi ubePZ DĚiU K ntj GřK (K) eĚvıqZ Kiab)

1. tUj i meĚg tKıvıU RıvřZ Drmıvx nb?
 K. cĕKıZK ubqg ev mĚ
 L. GKıU KıR KiřZ KZUKzngq cĕqıRb
 M. GK Rb Kgř KZUKzKıR Kiv DıPZ
 N. třřZ veÁıřbi ubqg ev mĚ|

2. civi křgřKi nvi ubařı Z nře mgq-mgxřıv řıvı, GıU tKıv bıvZ?
 K. Kıřřcřıvı e`e`ıcbı bıvZ
 L. vcm-řıU bıvZ
 M. mgq-mgxřıv bıvZ
 N. e`e`ıcbı KZŘ.ubqřı bıvZ|

3. KıvřřZ civi Kıı bı cıKıKıY bıvZ Abřıvqx Kgř`i`ıvıZ; nře tKıvıU?
 K. iayKıřı mřzm`ıv`b
 L. iayKıřı civi Kıı bı cĕřq
 M. iayntřKó.Kıřı cıvıZ ubařıY
 N. iayKıřı cĕřZ mgq ubařıY|

Av) msıřıB DĚi cĕœ

1. tUj iřK ěÁıvıK e`e`ıcbı RbK ej v nq tKb?
2. ěÁıvıK e`e`ıcbı bıvZ, řıv Dřı Kıab|
3. ěÁıvıK e`e`ıcbı mıdj`ıvı Kıab|
4. ěÁıvıK e`e`ıcbı řıvı-ıvıU eYřıv Kıab|



mivK DĚi

A) 1| M, 2| L, 3| K|

cW 3

tnbix d'iqj (1841-1925) Ges jyi ,ij K: cᄡvmbK cᄡuqvi cᄡ³v

Dᄡik

GB cW tkᄡl Avicᄡ—

- e'e-ᄡcbv mᄡúᄡKᄡd'iqj i avi Yv, tj v e³ KiᄡZ cviᄡeb;
- d'iqj cᄡE KᄡqKᄡU cᄡvmbK bᄡZi Dᄡj ᄡ KiᄡZ cviᄡeb;
- cᄡvmbK cᄡuqv mᄡúᄡKᄡj yi ,ij ᄡKi avi Yv e³ KiᄡZ cviᄡeb Ges
- POSDCORB kᄡᄡU e'vL'v KiᄡZ cviᄡeb|

fiqKv

diᄡvᄡ ᄡkíciᄡZ tnbix d'iqj (Henry Fayol) cᄡvmb I e'e-ᄡcbvi kᄡlᄡKvVᄡᄡgvi avi YvMᄡ ᄡelqveᄡj i Dci ᄡᄡkᄡ ᄡᄡbᄡᄡhᄡM ᄡᄡb| e'e-ᄡcbvi Dci`vb mᄡúᄡKᄡ avi Yv, tj v nj Zui ᄡᄡᄡᄡᄡ eo Ae`vb| ZᄡᄡK cᄡvmbK cᄡuqvi RbK eᄡj I ᄡᄡᄡᄡZ Kiv nq| ᄡZᄡb Zui Administration Industrille et Ge'nerale bvgK mᄡeL'vZ MᄡŠ' e'e-ᄡcbvi cᄡuqv mᄡúᄡKᄡᄡ ᄡelq, tj vi Dᄡj ᄡ Kᄡib ᄡm, tj v nj : To forecast and plan, to organize, to command, to coordinate, and to control. Gᄡᄡei e'vL'v cᄡᄡᄡᄡ ᄡZᄡb Dᄡj ᄡ Kᄡib:

To forecast and plan means examining the future and drawing up the plan of action. To organize means building up the dual structure, material and human, of the undertaking. To command means maintaining activity among the persons. To coordinate means binding together, unifying and harmonizing all activities and efforts. To control means seeing that everything occurs in conformity with established rule and expressed command.

cᄡvmbK cᄡuqvi bᄡZᄡᄡj v

cᄡvmbK cᄡuqv mᄡúᄡKᄡd'iqj DciᄡD³ ᄡ ᄡsÁv cᄡvb Kᄡib Zv cieZᄡKᄡᄡj i e'e-ᄡcbvi ᄡᄡᄡᄡᄡᄡᄡ DEᄡivEi cᄡᄡᄡZ Kᄡi Pᄡj ᄡQ| G Qvov d'iqj GK ,Q bᄡZᄡᄡj v ev Precepts-Gi ᄡsÁvᄡ cᄡvb Kᄡib| G, tj vi KᄡqKᄡU GLᄡᄡb Dᄡj ᄡ Kiv nj :

e'e-ᄡcK KZᄡj.Kiᄡeb Ges ᄡZᄡb—

1. Zui e'v³eMᄡmᄡúᄡKᄡcᄡjvciᄡj AeiᄡZ ᄡᄡeb;
2. ᄡᄡᄡMᄡᄡ i Acᄡvi Y Kiᄡeb;
3. cᄡZᄡvb I Kᄡᄡᄡ i eᄡb mᄡúᄡKᄡᄡᄡK avi Yv jvf Kiᄡeb;

4. GKwU DEg `pvsI`vcb Ki`teb;
5. cÅZõv`bi ch`eqµµgK wbi x`qY cwi Pvj bv Ki`teb Ges msw`qBmvti i PvU`Zwi Ki`teb;
6. cÅvb mnKvix`i g`ta`"bKU" `vc`bi j`q`" m`f`qj b Abõvb Ki`teb Ges Kv`Ri Dci Av`tj vKcvZ I w`b`Rbv cõvb Ki`teb;
7. cyLvbgyl mel`tq Av`Qbõv`teb bv Ges
8. Kg`i GKZv, kw³, D`"vM I AvbMZ" weKv`tki cÅZ j`q`" ivL`teb|

d`vqtji cÅvmbK cÅµqvi we`kdY AbyriY Kti j`yvi µij KI cÅvmbK cÅµqvi KtqKwU µiazpY`Dcv`v`bi K_v D`tj L Kti b| wZwb cÅvmbK cÅµqvi wevfba`Dcv`vb ev Kv`Ri Av`v`qji w`tq 'POSDCORB' bvtq GKwU kã `Zwi Kti b| wZwb P w`tq Planning, O w`tq Organization, S w`tq Staffing, D w`tq Directing, C w`tq Coordination, R w`tq Reporting Ges B w`tq Budgeting tevSv`Z tP`tq`Qb| w`b`P G Kv`R µtj vi eY`v t`I qv nj :

- **cwi Kí bv (Planning)**

cÅZõv`bi j`q`" AR`bi Rb" cÅvZ mek` Kvh`eq I Kg`Šv nj cwi Kí bv| KLb, tKv_vq, Kvi õviv, wKfv`te wK Kv`R Ki`Z n`te Zvi bKkvB n`"Q cwi Kí bv|

- **msMvb (Organizing)**

tKvb cÅZõv`bi cwi Kw`Z D`i k`veij AR`bi Rb" Gi Rbkw³`K msMvZ Ki`Z nq| msMvb ej`Z tevSvq cÅZõv`bi D`i k`" AR`bi j`q`" cÅZõv`bi Kvh`eqj i wefvRb I tkw`xKiY, `wqZmg`ni msAv wbi fcY Ges KZ`j. I qgZvi Kv`vtgv cÅZõv`kiY hv`Z Kg`v wR wR `wqZmg`h_vh_ cij`tb m`q`g nq|

- **Kg`ms`vb (Staffing)**

Rbkw³ ev Kg`vix`i õvivB `zwi nq cÅZõv`bi msMvb Kv`vtgv| m`Zivs cÅqvRbq Rbkw³ w`tqvM, Kg`i cÅk`qY I Kv`Ri Ab`kj cwi tek`Zwi Kiv Avek`K|

- **w`b`Rbv (Directing)**

mivK w`b`Rbv Oivov tKvb cÅZõv`bi j`q`" AR` m`e bq| Kv`RB cÅZõv`bi wbev`x Kg`ZMY`K wbi ew`Qb`v`te wmv`šI MõY Ki`Z nq Ges Z`vbv`q`x Kg`vix`i i mvariY I we`kI Av`k ev w`b`Rbv cõvb Ki`Z nq|

- **mg`š`q`mab (Co-ordinating)**

cÅZõv`bi Kg`e,` Ges wevfba`wefvM-Dcwefv`Mi g`ta" mn`thvMZv I thvMv`thvM `vc`bi gva`tg hveZiq Kv`Ri mvg`Am" weavb KivB nj mg`š`q` m`vab| mg`š`qi dtj mKj Kv`Ri g`ta" HK" cÅZwõZ nq Ges mvg`wKfv`te cÅZõv`bi Kvg" MwZ eRvq`_v`K|



cv#VĚi gj`vqb: 3

A) eū ubePbx cĕæ

m#WK DĚi ubt`Rgj-K Aŋiu#K eĚvqZ Kiab| (D`vniY: Avcbvi ubePZ DĚiu K ntj GtK (K) eĚvqZ Kiab)

1. d`vqtj i gtZ e`e`rcK tKvbuW Kiĕb?
 K. DĚg `pŕšl`rcb Kiĕb
 L. AthvM`i AcmviY Kiĕb
 M. cyLvbyL nel tq Av`Obanteb bv
 N. Dcti i me,tjv|

2. j yvi ,uj K cĕvmbK cĕuqvi KquW Dcv`vb ev Kv#Ri K_v Dtj L Kti#Qb?
 K. 5
 L. 6
 M. 7
 N. 8|

3. d`vqj Zvi ZĚej #Z Kvi Dci gtbnbtek Kti#Qtj b?
 K. e`e`rcK
 L. we#kIÁ
 M. klgK
 N. Aa`b KgPvix|

4. POSDCORB kãu#i R Aŋi i w`tq #K tevSv#bv nq?
 K. Reminding
 L. Recommending
 M. Reporting
 N. Recording

Av) msuŋB DĚi cĕæ

1. d`vqtj i KtqK#W cĕvmbK b#Z ev Precept Dtj L Kiab|
2. POSDCORB kãu#i e`vL`v w`b|
3. tUj i I d`vqtj i gta`ngj -Avqj Dtj L Kiab|

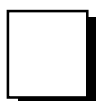

m#WK DĚi

A) 1| N, 2| M, 3| K, 4| M|

Employees should have a feeling that the company's goal is worth their effort; they should feel themselves part of the company and take pride in their contributions to its goal. This means that the company's objectives must be such as to inspire confidence in the intentions of management and belief that each will get rewards and satisfactions by working for these objectives.

metPřq cwi ZB msMVb metPřq `ř msMVb, GB AřřfgZuU gıvıeK mřúK©ZřĚj Eřař©Zřj aiv nřřřQ| AbıvřřmbK `j ,řj vřK řejıb ev `gb Kivi cwi eřřZ©G ,řjvi řgřıj K Pııı` ,řjv `řKıv Křı ıbřř cřZřvřřı j řřř`ı mřř_ Zı mřvřÄm`cř©Kıv nq| mřaviYZ gıvıeK mřúK©eıřř AřřřA I `ř mřřı fıvBRıvıMY G `ııqZj cıj b Křı _vřK| G ZĚj Abıvřřı cřııZMZ ı K řřřK e`e`ıcbıvı řřřř MYZııřř i ııZbııZ Abıııj b Kıv nřj Ges Kgeııřek msMVtb I Dbřř řıvıřıvıM `ıcbıvı řřřř Kge`ı AskMřřıYı Dci řRıvı ř`ı qıv nřj KZEřř I Kgeřıv řmřıv`©ı mřřřıvıM Zıvı ga` ıřř AřřK mğm`ıv I řřřıvı ıbımb NUvřř cıřı |

ıřřř cřıvřř gıvıeK mřúK©ZřĚj cřıvı

tıvıvı Gd K`ıvřřřřřı gZ ıe`ıj q cřıvřřř thme bııZřř gıvıeK mřúK©ZřĚj cřıZřř b Nřřřř Zı ıbgřřř:

- cřıvı ıřřřK/Aa`řř DĚg gıvıeK mřúK©eRıq řıřL ıřřřKřı`ı mřř_ GKK fıře Aıj ıv-Aıřř vPbıvı cıkvıvıı mřřřřř Z fıřeı Aıj ıv-Aıřř vPbıvı Kıřeb|
- gıvıeK mřúK©eıřřK ıřřřııKQıımğm`ıv ı ıřřř Zřř eřj gřb nřj I cıeZřřř ,ıřřřřř nřřř ř`Lı ř`q|
- cřıvı ıřřřK/Aa`řř MYZııřřř tbZZı cřıvřř AııK `ııqZřřıj nřeb, Kıvı Ab`ı`ı Zřřbıq ııZııb mřřıvıRbK Ae`ıřřı ıřřřřř|
- ıřřřKMY GKıı RıUj mřvııRK `j ıeavq ıe`ıj q cřıvřřř mZK fıře Zıř`ı mřř_ Aıj ıv-Aıřř vPbıvı Kıřřř nře|
- cřıvı ıřřřK/Aa`řř ıřřřK MřřıYı gřa` ıg_ıřřıvı mřřıvıM mřř Kıřeb hıřř ıřřřřıYı řřřřř mřeřř mğj cıvı qıv mře nq|
- řı ııııřřřı cřıvı thme ıřřřK ev ÷ıřřı Dci cöe eřj gřb nq řmB ııııřřıı MřřıYı řřřřř Hme ıřřřK ev ÷ıřřř mřú, Kıřřř nře|

gubueK m#úK©ZtÉj gj`iqb

10Ziq nekhtxi ci t_tK gubueK m#úK©ZtÉj Avte`b AtbKUl nwm tctZ _vtK,
 AvfthvM Dtv th GuU e`e`vcKt`i Kg©cwiPvj bvi GKUl tKŠkj Qrov Avi 1KQybq/
 GZ`mtÉj| gubueK m#úK©ZÉj AvR Aewa GKUl ,iazcy©e`e`vcbv ZÉj intmte c0avb`
 tctq AvmtQ| nekRto 1KŃv, e`emv I c0vmb LvZ c0Z ermi tKvU tKvU UvKv e`q
 nt`Q gvbe m#úK©Dbqb m#úKŠ bvbv ai#bi c0KŃY KgŃP#Z| e`emvi tKŠkj intmte
 bvbv ai#bi AevPvbK tKŠkj (Nonverbal Cues) thgb g,ynwm, `0tŃcY BZ`w`i
 e`envi, 1KŃtKi mvt_ ue`vj tq c0vb 1KŃtKi KtŃ mvtŃvKvi Kivi e`tj Abvb0mbK
 cwi#t#k mvtŃv Kiv, Avd#m AvZw_tK tPqvi t_tK Dtv `i Rvi Kv#Q 1Mtq AvgšY Rvbvtbv
 BZ`w`i ci`ú#i c0Z m#yb I m#úKZteva RvM#Z ht_ó mnvqK ntq _vtK| Avgt`i
 `b#`b Rv#b KgŃŃtĀ G ai#bi cwi#tek L0B `Ń`Ki I AvKwLZ `emK|



cv#VvEi gj`vqb: 4

A) eú ubePbx cĕœ

m#WK DĒi ubt`Rgj-K Aŋiu#K eĚv#qZ Kiab| (D`vniY: Avcbvi ube#PZ DĒi#U K ntj G#K (K) eĚv#qZ Kiab)

1. wek kZvāxi cŭg w`#K cĕvmb I e`e`vcbvi Ab`Zg`enkó` #Qj tKvbiU?
 - K. Aa`b#`i Av`v I mn#hvMZvi Dci , iaZ; Av#ivc Kiv
 - L. `j xq c#Póvi Dci , iaZ; Av#ivc Kiv
 - M. Aa`b#`i K#Vvi fv#e ubqšY Kiv
 - N. Kvi Mix`bcY`#K D#cŋv Kiv|

2. n_Y#ngxŋvi D#I`k` #Qj tKvbiU?
 - K. kĭgK#`i Kg#cwi#tek Dbz Kiv
 - L. kĭgK#`i Drm#n fvZv e#x Kiv
 - M. kĭgK#`i Drcv`b e#x Kiv
 - N. Drcv`b e#x i c#veK , t#v ubi#cy Kiv|

3. tKvbiU giv#eK m#úK#Z#Ēj c#v#ZMZ`enkó`?
 - K. Kg#cwi#tek MV#b Kg#`i AskM#Y
 - L. Av#b#v#bK `j mgn#K`gb ev #ej x#KiY
 - M. thvM#thvM`vc#bi tŋ#t# tM#v#bxqZv i ŋvKiY
 - N. mgn`v I Ø` ubi#b KZ#e#ŋi`v#qZ; M#Y|

Av) msu#B DĒi cĕœ

1. n_Y#ngxŋv #K D#I`k` cwi P#vj Z ntq#Qj ?
2. Gj Ub tg#qv tKiv #el q , t#v#K tK>`aK#i M#el Yv K#i#Q#t# b?
3. Gj Ub tg#qvi M#el Yvq #K Z` D`NvUb ntq#Qj ?
4. giv#eK m#úK#Z#Ēj kĭgK ev Kg# f#gKv KZUKZ eY#v Kiab|
5. giv#eK m#úK#Z#Ēj K#qK#U c#v#ZMZ`enkó` D#t# K Kiab|



m#WK DĒi

A) 1| M, 2| N, 3| K|

fvgKv

Argiv Rmb, ckvmb gvTIB DfIk`gla Ges msMVbKw`K| j Q" I DfIk` AR#bi Rb`
msMVibK Kvhfej i mgwi Pvj bvtK ckvmb ejv thtZ cvti| evsj vt`tki mmeR ukQlv
e`e`v GKUJ msMVibK KwVtgv AvI Zvq Mto DfVtQ| GQvor cU`igK, DcivbymbK,
gva'igK I D"P gva'igK Ges Kvi Mvi ukQlv e`e`vi Rb` c`K c`K msMVibK KwVtgv
itqtQ| eZgv BDibU evsj vt`tki gva'igK ukQlv tciZ ukQlv e`e`vi msMVibK
KwVtgv m`utK`Avtj vPbv Kiv ntqtQ| BDibUitK tgvU wZbuU cvtV fVM Kiv ntqtQ| cU`g
cvtV ukQlv gS'Yj q m`uik`Z Avtj vPbv `vb tctqtQ| wZxq cvVUitZ gva'igK I D"P ukQlv
Awa`Bi Ges ZZxq cvtV AvAj K ukQlv cwi`Bi Ges tRj v ukQlv Avdm m`utK`Avtj vPbv
Kiv ntqtQ|

- cvV- 1: ukQlv gS'Yj q: msMVb, `wqZ; Ges Kvhfej
- cvV- 2: gva'igK I D"P ukQlv Awa`Bi
- cvV- 3: AvAj K ukQlv cwi`Bi I tRj v ukQlv
Avdmi `wqZ; Ges Kvhfej

cW 1

uk`qv gšyvj q: mslMb, `wqZ; Ges Kvhøj

Dt`k`

GB cW tk`l Avcib—

- t`tki mweR uk`qv e`e`vi mslMbK KvvtgV A½b KiTZ cvi`eb;
- uk`qv gšyvj tqi AiMt`bvMóg m`útk`ej tZ Ges tevSrtZ cvi`eb;
- uk`qv gšyvj tqi `wqZ;l Kvhøj eY`v KiTZ l e`vL`v KiTZ cvi`eb Ges
- uk`qv gšyvj q l Gi Avl Zvaxb mslMb`uj i cwi`vPvZ w`tZ cvi`eb|

uk`qv gšyvj q: mslMb

t`tki mweR uk`qv e`e`vi mtePP chq uk`qv gšyvj tqi Ae`vb| uk`qv gšyvj tqi c`vb ube`rx ntjb uk`qvgš| Ztk mnvqZv Ktib uk`qv mipe| uk`qv gšy GKRb ivR%bwZK e`vZij Aciw`tk uk`qv mipe ntjb c`kvmubK K`vWt`ii mtePP chq GKRb miKvix KgRZPj GQovl uk`qv gšyvj tq itqtQb GKRb Awzi³ mipe, wZbRb hMmipe, Oq Rb Dc-mipe, tlvj Rb mnKvix mipe Ges Ab`b` KgPvix`| uk`qv gšyvj tqi m½ msuk` itqtQ GKw cwi`Kibv tKvl | GB cwi`Kibv tKvli `wqZ;AvtQb GKRb c`vb, `Rb Dc-c`vb Ges `Rb mnKvix c`vb| GQovl itqtQb Ab`vb` ÷vd| cwi`Kibv tKvl uk`qv gšyvj tqi Aaxb` weifbems`v KZR.tckKZ.Dbqb c`Kimg n PovšKt`yi ci tm`uj gšyvj tqi Abtgv`tbi e`e`v Kti| ersj v`k b`vkbvj Kvgkb di BDtbt`v mst`qtc we.Gb.wm.BD bvgK c`Zövbw| uk`qv gšyvj tqi Kvvtgvi m½ hš| c`vavrietj uk`qvgš GB c`Zövtbi tPqig`vb Ges uk`qv mipe Gi grvmipe| we.Gb.wm.BDi Avclm c`vtbi c`ex nt`Q mipe| GB c`Zövbw BDtbt`v KZR MpxZ weifbæKg`mP ev`evqb Kti| uk`qv gšyvj tqi mweR Kvhøjtgj Abt½ wnmte Avl itqtQ cwi`k` l wnmve wbxqv cwi`Bi Ges d`vnmij wUR wefivM| cwi`k` l wnmve wbxqv Avv`Bt`ii c`vb `wqZ;nt`Q temiKwi uk`qv c`Zövtbi teZb fvZw` l Ab`vb` LvTZ e`uqZ miKwi A`_P m`envi wvöZKiY| G Dt`k` Avv`Bt`k cwi`k`bi `wqZ; cij b KiTZ nq| uk`qv gšyvj tqi Avl Zvq weifbæuk`qv c`Zövb wvgP l m`v`i i `wqZ; d`vnmij wUR wefv`Mi Dci b`v`l|

`wqZ; Ges Kvhøj

t`tki mweR uk`qv e`e`vi bwxZ wbaP`K wnmte uk`qv gšyvj tqi Ae`vb| uk`qv m`úwKZ weifbæAvBb, weva, c`eva c`vqb Ges Avt`k wbt`R Rvvi Kiv uk`qv gšyvj tqi KvR| uk`qvi m½ m`úwKZ weifbæAvšt`gšyvj q mspvš`iel qvej i wv`úwE Ges t`Lvtkvbr Kivl uk`qv gšyvj tqi Ab`Zg `wqZ;|

ესჯღ`ტი უკწვ ცბუმბ I ე`ე`ცბვი მუეჩ კუტგვ

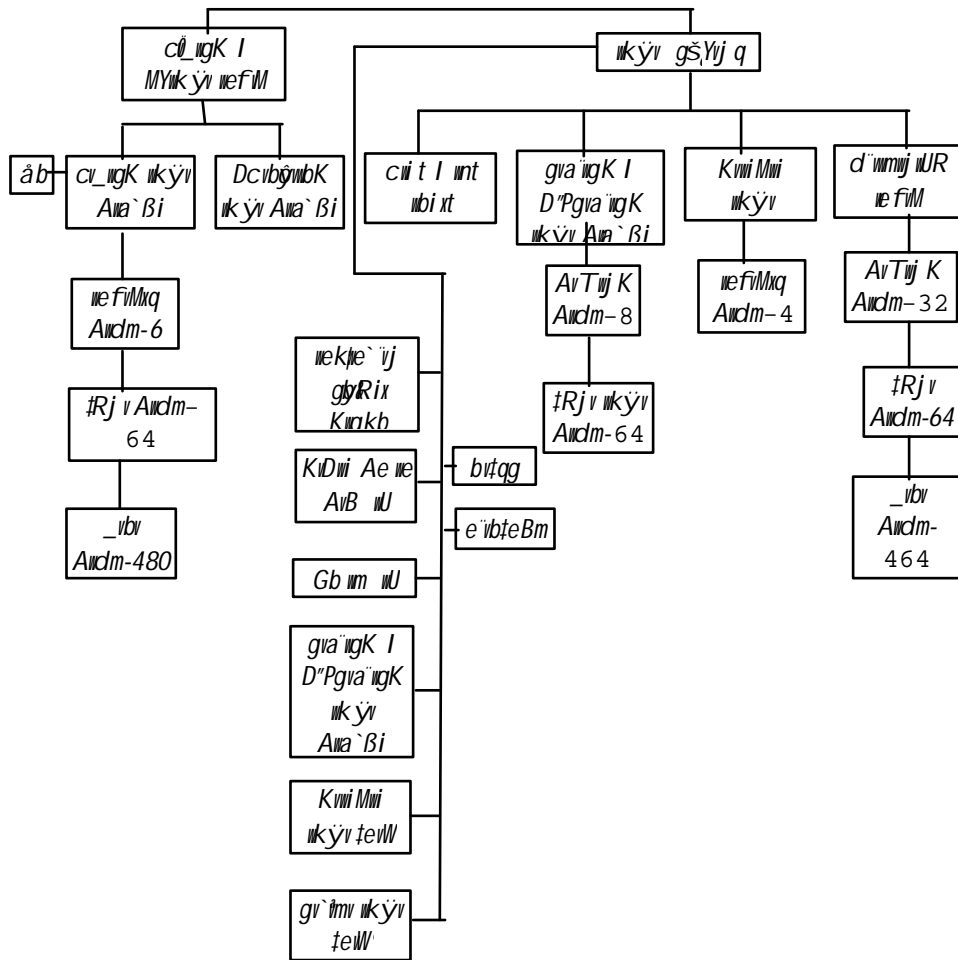

მსტწტც უკწვგს`ჱი ჟი `ნიკZ; Ges K`იხ`იე`იჯ ჟK იბგუჯ იLZ`f`ტე t` L`v`ბი th`Z ც`ტი:

1. ბნიZ იბაწY;
2. უკწვ მს`მუ`ს`ი იეფ`ბეA`vB`b ც`ყბ Ges იეწაიე`vბ R`ნი;
3. t`ტი მუეჩ უკწვი R`ბ` უკწვიბნიZ ც`ყბ K`ივ;
4. K``W`i f`Z K`gR`Z``i იბტ`q`M, e``j`x I c``v`ბეZ Ges A`e`i M`ბ`ჟ`Yi P`p`v`ს`i A`b`გ`ნიZ ც``v`ბ;
5. უკწვი მს`იკ`ბ K`gR`Z`P`I K`g`P`v`i`ჟ`i t`e`Z`b`-f`v`Z`v`i t``j` იბაწY;
6. t`c`k`v`M`Z D`b`q`ჟ`ბ`i j`ჟ`წ` უკწK Ges იეფ`ბეK`gR`Z``i R`ბ` t``ჟ` I იე``ჟ`k` ც`ბ`K`წ`ჟ`Yi ე`e``v` K`i`v;

7. ʔkʔvi Dbəʔbi j ʔʔi ʔeʔfbəʔkugkb MVb;
8. Dbəʔb cʔkí mgʔni Abʔgv b I ev ʔevqʔbi c ʔʔc MʔY;
9. ʔkʔvi ʔeʔfbə ʔi i Rb ʔkʔvi ʔug cʔqʔbi bʔiZgvj v ʔbaʔʔ Y Ges ʔkʔvi ʔug ev ʔevqʔbi j ʔʔi Avʔ k, ʔbʔ R I mnʔhʔMZv cʔvb;
10. DʔP ʔkʔvi ʔʔʔi ʔeʔ cʔvʔbi e ʔe v MʔY;
11. Aaxb ʔ Aʔa ʔBi, cʔi ʔBi Ges ms ʔimgʔni Kvhʔrg Abʔgv b Ges ev ʔevqʔb mnʔhʔMZv cʔvb;
12. RvZiq ʔkʔvi evʔRU cʔqʔb (gʔʔij ʔqi Aaxb ʔ ʔeʔfbə Aʔa ʔBi, ms ʔ I cʔZʔvb KZR. cʔxZ evʔRU ʔkʔvi gʔʔij ʔqi mfivq Avʔj ʔPZ I Abʔgv ʔ Z nevi ci Pəʔʔi Abʔgv ʔbi Rb ʔ Zv A ʔgʔʔij ʔq ʔcʔY Kiv nq)
13. ʔbʔ ʔ mgq Aʔʔi ʔ ʔki mnʔeR ʔkʔvi e ʔe v Dbəʔb I cʔMʔʔbi Rb ʔ Dʔ ʔM MʔY/

AMʔbulMg

ʔkʔvi gʔʔij q

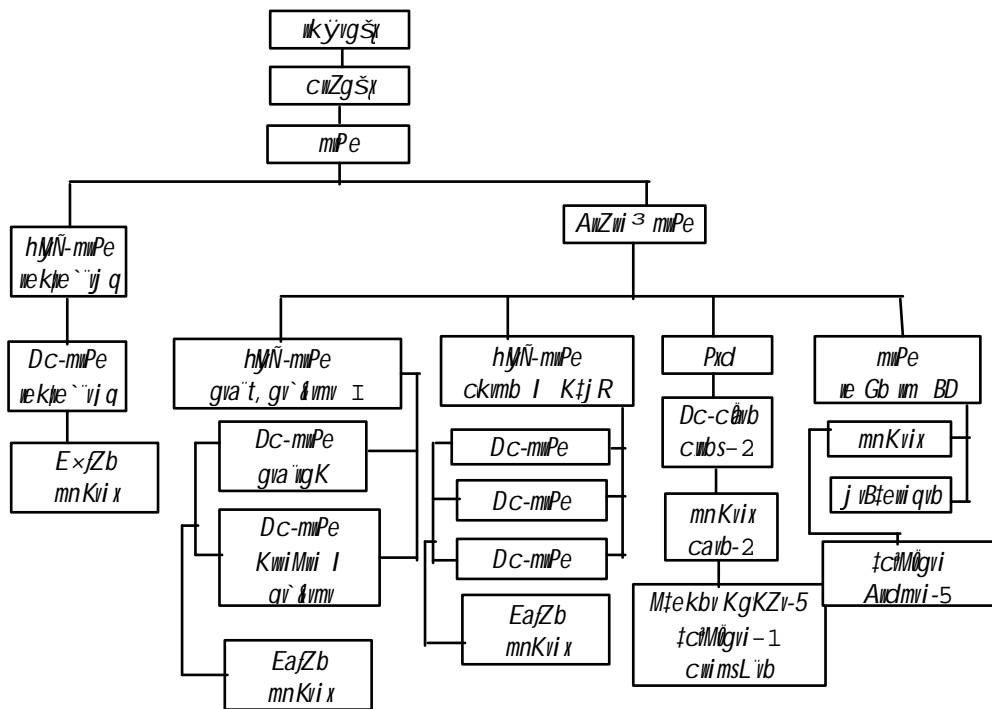



cv#V#Ei gj`iqb: 1

A) e# ubePbx c#æ

m#WK D#Ei ub#`Rgj-K A#i#U#K e#v#qZ Kiab| (D`vniY: Avcbvi ube#PZ D#Ei#U K ntj G#K (K) e#v#qZ Kiab)

1. uk#v g#y#j #qi c#vb ube#x tK?
 - K. i v#Z
 - L. c#vbg#j
 - M. uk#vg#j
 - N. uk#v m#Pe|

2. c#i`k# I #mve ubix#v A#`B#i i c#vb `v#Zj tKv#U?
 - K. miK#i c#Z#vb #j #Z e`v#Z A#_P m#`envi ub#ZKiY
 - L. temiK#i c#Z#vb #j #Z e`v#Z miK#i A#_P m#`envi ub#ZKiY
 - M. temiK#i c#Z#vb #j #Z e`v#Z miK#i I temiK#i dv#Ui A#_P m#`envi ub#ZKiY
 - N. c#i`k# Kvh#m#v`b|

Av) iPbv#j-K c#æ

1. uk#v g#y#j #qi `v#Zj Ges Kvh#ej D#j# Kiab| t`#ki m#e# uk#v e`e`vi Db#b I c#v#i Rb` G mKj `v#Zj I Kvh#ej i tKvbiKg c#ieZ# I c#i gvR#bi c#qvRb Av#Q uk? Avcbvi m#v#Z gZv#Z e`³ Kiab|



m#WK D#Ei

A) 1| M, 2| L|

cW 2

gva`ngK I D`PikŃv Awa`Bi

DŃk`

GB cW tkŃl Avcib—

- gva`ngK I D`PikŃv Awa`BŃi mvsMvibK KvVtgv A¼b I eYŃv KiŃZ cviŃeb;
- gva`ngK I D`PikŃv Awa`BŃi Aaxb`wevfbaKvLvi `vqZj I KvHŃej m`uŃK`ej ŃZ cviŃeb Ges
- Awa`BŃi `vqZj Ges KvHŃej i Zvuj Kv cŃq b KiŃZ cviŃeb|

msMvb

gva`ngK I D`PikŃv Awa`BŃi mŃeP cŃ` iŃqŃOb GKRB gnvci Pij K| vZvb Awa`BŃi cŃvb| gva`ngK I D`PikŃv Awa`Bi gva`ngK vKŃv, gv`Ńv mŃv vKŃv Ges KŃj R vKŃvi cŃvmb I e`e`vcvvi mŃieR `vqŃZj vbtqvRZ| Awa`BŃi mvsMvibK KvVtgv tgvU cŃvU kvLv vbtq MvZ| kvLv, vj nj :

1. KŃj R I cŃvmb kvLv|
2. gva`ngK vKŃv kvLv|
3. cvi KŃv I Dbqb kvLv|
4. cŃkŃY kvLv|
5. kvixvi K vKŃv kvLv|

KŃj R I cŃvmb kvLv cŃvb nŃj b GKRB cvi Pij K| ZvŃK mŃvqZv Kivi Rb` iŃqŃOb vZbRb Dc-cvi Pij K, Pvi Rb mŃKvix cvi Pij K, Pvi Rb vKŃv Avdmvi, GKRB cŃvmbK KgRZP, GKRB vŃmveiŃY KgRZP Ges Ab`vb` mŃvqK ÷vd| KŃj R I cŃvmb kvLv gj-Z mi Kvi KŃj ŃRi vKŃKŃ`i vbtqvM, e`vj, c`Ńv vZ, QvŃ, tcbmb Ges temi Kvi KŃj ŃRi vKŃKŃ`i Gg.vc.I fŃŃ I KŃj ŃRi `ŃKvZ. cŃvb mŃvŃŃi KvR KŃi _vŃK|

gva`ngK kvLv cŃvb vŃmŃe GKRB cvi Pij K iŃqŃOb| ZvŃK mŃvqZv KŃi b `ŃRb Dc-cvi Pij K, Pvi Rb mŃKvix cvi Pij K, Pvi Rb vKŃv Avdmvi Ges Ab`vb` mŃvqK ÷vd| gva`ngK kvLv gva`ngK `Ńj i vKŃKŃ`i vbtqvM, e`vj, cŃ`v vZ, Aemi MŃY Ges temi Kvi gva`ngK `Ńj i `ŃKvZ. cŃvb I vKŃKŃ`i Gg.vc.I fŃŃi KvŃR vbtqvRZ| GQvov gva`ngK kvLv gv`Ńv mŃv vKŃKŃ`i Gg.vc.I fŃŃ Ges gv`Ńv vj i `ŃKvZ. cŃvb KŃi _vŃK|

cvv KŃv I Dbqb kvLv cŃvb nŃj b GKRB cvv Pij K| ZvŃ AaxŃb iŃqŃOb GKRB Dc-cvi Pij K, `ŃRb mŃKvix cvv Pij K, `ŃRb MŃel Yv Avdmvi Ges vKQymŃvqK ÷vd|

gncւիՍյ K miKւիi th mKj cԷԻի ւեթիx cձւb, GB kvLՎ gj-Z tmBme cԷի ev~եւզb mսւսճիKւR Kիi _ւԷK|

kvixi K ւեթիx kvLՎi cձւb ntj b GKRb Dc-ցւիՍյ K| ZԷK mnvզV cձւb Kիi b ԷՐb mnKւix ցւիՍյ K, ԷՐb ւիւն Aւււմի Ges GKRb MեIYՎ KցՔZԷ| GB kvLՎ cձւbZ ւեթիx cձՅձւb, ւի i ւիւն I kixiPPP mսւսճի ւեI q Է՛LւիՅւ Kիi Ges ււմԷ AvՏԷ~ջ ւիւն cձZԷthւMZՎi AvԷղւRb Kիi _ւԷK|

Avա՛Բիi cԷԷԷY kvLՎւմ ւեթիx bexb| GB kvLՎi cձւb ntj b GKRb ցւիՍյ K| Zւի AաԷԲ AvԷՕb GKRb Dc-ցւիՍյ K, GKRb mnKւix ցւիՍյ K Ges GKRb MեIYՎ KցՔZԷ cԷԷԷY kvLՎ ւՍՍւմԷԷԷ Kիj R Ges Av՛ւb՛ ւեթիx cձՅձւb, ւի i ւեթիԷԷԷԷ i cԷԷԷԷԷԷԷ ւ՛Kււ Է՛LւիՅւ Kիi |

AMԷԷԷԷԷ

gva՛ւգK I D՛Ս ւեթիx Avա՛Բի

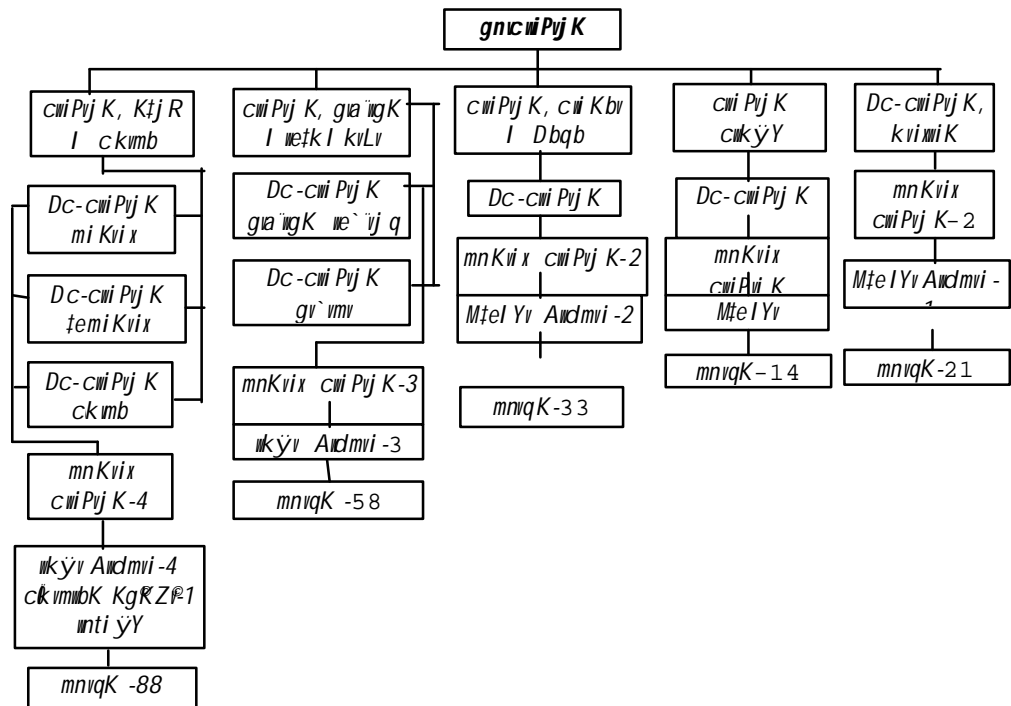

gva՛ւգK I D՛ՍԷթիx Avա՛Բիi ~ւզZ; Ges Kւեթիx

ւեթիx mսւսճիԷԷԷ gva՛ւգK I D՛ՍԷթիx Avա՛Բիi ~ւզZ; Ges Kւեթիx AvԷj ՎԲՎ Kիv nj :

1. gva՛ւգK I D՛Ս gva՛ւգK ւեթիx mսւսճի mi Kւիi Է՛LւիՅւ ev~եւզb;

2. ukʻv msvšbmvZ cŵqʻbi e`vcvʻi ukʻv gšYvj qʻK mrvqZv Kiv;
3. ukʻv cŵZŵvb,uj i GKvʻWvgK Kivʻeuj i e`vcbv I Z`vi uK;
4. temi Kvi ukʻv cŵZŵvb mi Kvi vbt`R ev`bvqʻbi cŵqvRbvq e`e`v MŵY;
5. Dbqb cKʻi i AvI Zvq mi Kvʻi i Dbqb KvʻRi Z`vi Kx;
6. mrvvi Y ukʻvi gvʻbvqʻb e`e`v MŵY;
7. t`k Ges vett`k `q I Kʻj R ukʻvKʻ i cŵkʻʻYi e`e`v Kiv;
8. mi Kvʻi i vevfbvvefvʻMi mʻ½ thvMvʻthvM i vʻv Kiv;
9. ukʻv cŵZŵvb,uj i mKj KvRKʻgʻ mgšq mrvab Kiv;
10. mi Kvi ukʻv cŵZŵvb bZb tKvmʻelq cŵZʻbi Rb` AvZvi³ c` mʻó Ges tfšZ mʻeav evx i c`ʻʻc MŵY;
11. temi Kvi ukʻv cŵZŵvb cvi Pij bvi Rb` AveZʻ gÄjx cŵvb;
12. temi Kvi ukʻv cŵZŵvb i ukʻvK/KgPvi x` i teZb LvʻZ mi Kvi Abʻvb cŵvb;
13. bZb temi Kvi ukʻv cŵZŵvbʻK mi Kvi Abʻvb cŵvʻbi e`e`v;
14. ukʻv Ges ukʻv cŵZŵvb,uj i gvʻbvqʻb i jʻʻ cKʻi `Zvi;
15. Avv`Bivaxb Avdm/ukʻv cŵZŵvb i vR`^I Dbqb LvʻZi evʻRU cŵqb, e`q gÄjx I vrvvi vʻvʻ



ԵԿՎԵԻ ԳՅ՝ՎԳԵ: 2

A) e՛ւ ԵԵԲԲԽ շԿԵ

ԵԿՎԵԻ ԵԵ՛՝ՔԳՅ-Կ ԱԳՅԻԱԿԵԿԵ ԵԿՎԵԶ ԿԻԵԿ | (Ը՝ՎԵԻԿ: ԱՎՇՎԻ ԵԵԲԲԶ ԸԵԻԱԿ Կ յԵՅ ԳԵԿ (Կ) ԵԿՎԵԶ ԿԻԵԿ)

1. ԳՎ՝ՎԳԿ Ի Ը՛Փ ԵԿԳՅ ԱՎԵ՝ԲԵԻ ԵՎՍՄՎԵԿ ԿՎՎԵԳՎԵԶ ԵԳՎԱ ԿԳՅԱ ԿՎԼՎ ԱՎԵԶ?
 - K. 3 յԱ
 - L. 4 յԱ
 - M. 5 յԱ
 - N. 2 յԱ |

2. ԵԵ՛ՔԻ ԵԿՎԵ ԿՎՐ՝ՎԳ ԱՎԵ՝ԲԵԻ ԳՎ՝ՎԳԿ ԿՎԼՎԻ ԱՎԻ ԶՎԻԶ?
 - K. ԳՎ՝ՎԳԿ ՝ճԵՅ Ի ԵԿԳՅԱ՝Ե՛Ի ԵԿԵ՛ ՇՕՎԵ
 - L. ԳՎ՝ՎԳԿ ՝ճԵՅ Ի ԵԿԳԿԵ՛Ի ՇԿԳԿԵ՛Ի ԱՎԵԳՎԵԲԻ
 - M. ԵԵԻԿՎԵԻ ԳՎ՝ՎԳԿ ՝ճԵՅ ԳԵՍ ԳՎ՝ՎՄՎ ԵԿԳԿԵ՛Ի ԳԳՎԻԿ ԲԻԶ
 - N. ԵԵԻԿՎԵԻ ՝ճԵՅ ՇՎԻ՛ԿԵԻ |

AՎ) ԻԲՎԳՅ-Կ ՇԿԵ

1. ԳՎ՝ՎԳԿ Ի Ը՛ՓԵԿԳՅ ԱՎԵ՝ԲԵԻ ԵՎՍՄՎԵ ԳԵՍ ԿՎԵՎԵՅ ԵԿՎԵԿ՝ՄՍԵԿ՝ՄՍԵԿ՝ՄՍԵԿ ԵՅ ԼԵԿ | ԳՎ՝ՎԳԿ Ե՛՛ՅՅՅ ԵԻ ԸԵԳԵԿԵ՛Ի ԳՄԿՅ ՝ՎԳՅԵՅ Ի ԿՎԵՎԵՅ ՇՎԵԲԲՎԻ ԵԿՎԵ ԱԵԿՎԵ ԱՎԵԶ ԵԿԿ? ԵԲՐ՝ԳՅՎԳՅ Ե՛ԵԻ |



ԵԿՎԵԻ

- A) 1 | M, 2 | M |

cW 3

Av`Aj K ukŕv cwi`Bi I tRjv ukŕv Avd`mi `wqZ;Ges Kvheij D`ik`

GB cW tk`I Avcib—

- Av`Aj K ukŕv cwi`Bi Ges tRjv ukŕv Avd`mi mvsMvibK ifctiLv c`vb Ki`Z cvi`teb Ges
- Av`Aj K ukŕv cwi`Bi Ges tRjv ukŕv Avd`mi `wqZ; I Kvheij eY`v I e`vL`v Ki`Z cvi`teb|

Av`Aj K ukŕv cwi`Bi: `wqZ;Ges KvR

gva`ngK I D`Pukŕv Awa`Bti Aaxtb bqul Av`Aj K cwi`Bi Av`Q| Av`Aj K cwi`Bi ,ij XvKv, gqgbwmsn, P`EM`g, Kwj v, ivRkvnx, iscj, Ljyb, vmtj U Ges ewi kv`j Aew`Z| cwi`Bti c`v`b c`ex n`Q Dc-cwi Pij K A_ŕ Dc-cwi Pij K ntj b Av`Aj K Avd`mi c`v`b| Zui Aaxtb i`q`Qb GKRb ve`'ij q cwi`kR, GKRb ve`'ij q cwi`ukRv, GKRb mnKvix ve`'ij q cwi`kR, GKRb mnKvix ve`'ij q cwi`ukRv, GKRb nmvei ŕŕY KgRZP I Ab`vb` mnvqK ÷vd| Av`Aj K ukŕv cwi`Bti `wqZ;Ges Kvheij vbg`efc:

1. ve`'g vb veia veavb Abjvqx vbg`gva`ngK ve`'ij q `v`ctbi ceŕbgvZ c`vb;
2. vbg`gva`ngK ve`'ij tqi GKv`WngK `ŕKwZ. c`v`b Rb` ve`'ij q cwi`kR, cwi`kR c`Z`te`b gva`ngK I D`P ukŕv Awa`Bti tc`Y Ges Awa`Bti Ab`g`v`b Mh`Yi ci `ŕKwZ. c`vb;
3. EaY`Zb KZ`e`ŕji vbt`ŕk beg I `kg tk`Y tLjvi Abg`vZ c`v`b Rb` ukŕv c`Z`v`b cwi`kR Ges Awa`Bi I tevW`eivei c`Z`te`b tc`Y;
4. EaY`Zb KZ`e`ŕji vbt`ŕk gva`ngK I D`P gva`ngK ve`'ij tqi `ŕKwZ. c`v`b Rb` cwi`kR Ges c`Z`te`b msuk`Bti c`vb;
5. veia Abjvqx vbg`gva`ngK ve`'ij tqi `ŕKwZ. bevq`bi e`e`v Mh`Y;
6. veia Abjvqx gva`ngK ve`'ij q I `v`Lj gv`&v`vi gv`v`b`Rs Kvgu`ji ve`'v`jv`Mx m`m` g`v`v`q;
7. vbg`gva`ngK ve`'ij tqi Gv`nK/vbq`vZ gv`v`b`Rs Kvgu`ji Ab`g`v`b;
8. tRjv ukŕv Avd`mi Kv`Ri Z`vi Kx;
9. msuk` AA`tj i vbg`gva`ngK I gva`ngK ch`ŕqi ukŕv c`Z`v`bmg`ni ukŕvi , YMZ gv`b Db`q`k`i c`q`v`Rb`q Kv`ŕig Mh`Y;

֛՛ջ Ae GW#Kkb

- 10. mi Kwi I temi Kwi gva'igK I ubgægva'igK Ges `vLj ch#qi uk'v c#Z#v#bi GKv#WigK Ges cl'vmubK cwi`k# I msuk# `Bimg#n (Ava`Bi, ubix'v Ava`Bi, tevW'Ges Gb'v'Uve) cwi`k# c#Z#e`b tc#Y;
- 11. mi Kwi A_#q#b Dbq#bi Rb` ubv'Z uk'v c#Z#v#bmg#ni Dbq#b Kv#Ri Z`vi Kx;
- 12. Dc-e#E c#vb Kv#Ri Z`vi Kx I vi#cvU#c#vb;
- 13. R#bqi e#E cix'v cwi Pvj bv|

tRj v uk'v Avdm: `vqZ;I KvR

t`tki 64uU tRj vq 64uU tRj v uk'v Avdm itqtQ| tRj v uk'v Avdm, vj gva'igK I D'Puk'v Ava`B#i AvL Zvq Ava`B#i ubq#Y'vxb| tRj v uk'v Avd#mi c#vb n#j b tRj v uk'v Avdmvi | Z#K mnvqZv K#i b GKRb mnKvix tRj v uk'v Avdmvi, GKRb vnmvei #K I #KQymvqK KgPvix|

tRj v uk'v Avdm, vj c#vbZ ubg#j uLZ `vqZ#mgn# cvj b K#i _v#K:

- 1. mKj temi Kwi uk'v c#Z#v#bi teZb, fvZv# c#v#bi j#q# c#qvRbxq KvMRc# cix'v#s# uk'v g#Y'vq, gva'igK I D'Puk'v Ava`Bi Ges Av#vj K Dc-cwi Pvj #Ki `Bi tc#Y;
- 2. cwi`k# I ubix'v cwi`Bi KZR.AvU Avci#i Reve c#vb uk'v KZR.c#v#bi ci g#e`mn EaY#b KZE#q#i Kv#Q tc#Y;
- 3. temi Kwi uk'v c#Z#v#bi Avf#v#Mi vfi#Z Z`#Ki Y;
- 4. `vDU I MvBW Kv#p#tg g#Y'vq#i ub#`Rmgn# ev`#vqb cwi ex'vY;
- 5. e#q#ivcY Kv#p#tgi AMv#Z cwi ex'vY Ges e#q#ivcY I msi#q#i Rb` uk'v c#Z#v#b c#vb#K D#Y#Ki Y;
- 6. mi Kv#i i ub#`Rbv tgvZv#eK M#xZ mncv#v#igK Kv#p#tgi ev`#vqb gubUvi s;
- 7. RvZxq uk'v m#vnmn v#f#v# em I Kg#v# cvj #b uba#i Z`vqZ;cvj b;
- 8. RvZxq ֛՛ջ I gv`&v#v #xov m#v#Zi _v#v #_#K tRj v ch#s# m#Mv#b, cwi Pvj bv I ubq#Y Ges tRj vfi#K #xov#v#v#bi t#q#T c#qvRbxq mnvqZv c#vb;
- 9. R#bqi e#E cix'v cwi Pvj bvq mnvqZv c#vb;
- 10. mi Kwi I temi Kwi ubgægva'igK I gva'igK ֛՛ջ Ges `vLj ch#qi gv`&v#v GKv#WigK I cl'vmubK cwi`k#;
- 11. v#f#v#Kv#R Av#vj K uk'v Ava`Bi #K mnvqZv c#vb|

cW 1

Kgŕe`e`ıcbvi A_©, iaZjI cÖqvRbxqZv

Dřİk`

GB cW tkřI Avıcb—

- Kgŕe`e`ıcbv ej řZ ıK tevSvq Zv ıeeZ KiřZ cviřeb Ges
- cÖZÖvřbi j řI I Dřİk` ARřb Kgŕe`e`ıcbvi , iaZje`vL`v KiřZ cviřeb|

Kgŕe`e`ıcbvi A_©

h_vh_ ıbt`R, cviPvj bv I ıbqřřYi gvařg cÖZÖvřbi Kgŕe`ıK `^`^`vıqZj cıj řb DrmıvıZ KivřK Kgŕe`e`ıcbv ejv thřZ cviřI | GKRB cÖvmK ev e`e`ıcbřKi ıbt`R hLb Kgŕe`ı i gřS cřıveřKi KivR Kři, ZLbB Zıř`i gıřS tcÖYv mıř I Kg`úıv RıMÖZ nq| KivRB ejv hvq, ıbt`R cÖvřbi , YMZ `eıktó`i Dci msMVb Z_v Kgŕe`ı i Kg` ZrciZv ıbfP Kři |

ıKŕıv cÖvmřbi řŕıřI gıvıeq m`ú` k`ııU AıaKZi Zırch`enb Kři | KivY ıKŕıv cÖZÖvřbi hveZıq Kivhıej B gıvıe mřřřbi DbıZi j řŕı ıbtew Z| ıKŕıv cÖZÖvřb msıkw e`ıı³eřMŕ gıřS Dchŷ ıbt`Rbv, tcÖYv I KgZrciZv mıřı gvařg ıKŕıv cÖZÖvřb Z_v ıKŕıvi Dbıqb ıKŕıvřŕıřI Kgŕe`e`ıcbvi Ab`Zg j řI|

“Human management includes the employment of suitable persons with adequate motivation to put in their best, living up of the payment of their salaries, providing of in-service training, formulating policies and methods to unite the entire body of workers in an attitude of enthusiasm to achieve the best possible results.¹

BřtiıR AbřıQ`ıU ř_řK Kgŕe`e`ıcbvi KřıKııU `eıkw` j řI Kiv thřZ cviřI :

1. chřř tcÖYv m`ıj Z Dchŷ KgŕıbtqıM hvıv h_vm`e kŷ`vb ev Kgŕııúv`řb Dıgıy;
2. Kgŕe`ı i cviı kıgK ev teZb cÖvřbi h_vh_ e`e`ıv MıřY;
3. Kgŕıvj ıb cÖkŕıřıYi e`e`ıv;
4. mřteĚg dj jıřfi j řŕı` Kgŕe`ıK Dıřcbıgıj-K `ıřfıw/2 mnKıři GKıřZ Kiv Ges GRb` h_vh_ bııZ I c`ııZ cřıqb Kiv|

GKııU ıKŕıv cÖZÖvřbi Kgŕe`e`ıcbvi Avı Zıvq ıKŕıv_ŕı, ıKŕıK Ges Ab`ıv` mıvıqK ÷ıřřdi bıv Dřj L Kiv hvq| Gř`ıřK ıNřıB ıKŕıv cÖZÖvřbi hveZıq Kgŕe`ıvı AvenZřI|

¹ L.I. Gupta, Educational Administration, P-68.

Kg#e'e'vcbvi , iaZ;

Av#MB ejv n#q#Q Kg#e'e'vcbvi ej #Z Ggb GK#U e'e'vcb#K tevSvq hv c#Z#v#bi Kg#e' i gv#S-

(K) tc#Yv m#p# K#i

(L) Drm#n I D#i#cbv m#p# K#i Ges

(M) Kg#e'ú#v RvM#Z K#i A_#|

Kg#e' #K c#Z#v#bi Db#b Ges j # AR#bi Ab#Zg n#v#Zqv# n#m#e' #Zvi K#i |

c#Z#v#bi m`m` n#m#e' GK#b e'v#i `# m#Ej j # Kiv hvq| GK#U Zvi e'v# m#Ej, Ac#U `j#q m#Ej| D#Eg Kg#e'e'vcb#q GK#b c#Z#v#b c#v#b e'v#i GB D#q m#Ej c#Z mgvb , iaZ; #`b| Kv#RB GK# #K thgb e'v#i P#n`v c#Y nq, #Zg#b `#j i P#n`v c#Y nq| G `#i m#zng#q c#Z#v#bK j # AR#K Zj v#Z K#i |

m#M#b gv#T#B `# c#v#g#j v#v#R K#i| GK#U c#Z#v#bK c#v#g#j, Ac#U e'v#M#Z c#v#g#j | c#Z#v#bK c#v#g#j i#q#Q c#Z#v#b, f#v#Kv Ges c#Z'vkv| f#v#Kv #v#v f#v#Kv Av#Kv#x e'v#i Av#i Y#K tevSvq| A_# e'v# th f#v#Kv ev c# i#q#Q, tm c` ev f#v#Kv m#v#k# Av#i#Yi ga` v`#q f#v#Kv i#c c#v`v n#`Q| G Q#v#v c#Z#U f#v#Kv m#½ #KQy `vq`v#q#Z; ev ev#evaKZv`v#K| G ,# #K ejv hvq c#Z'vkv| e'v# v#R v#R f#v#Kv c#j #bi ga` v`#q GB c#Z'vkv c#Y K#i`v#K| GB c#Z'vkv #v#ea- c#Z#v#bK c#Z'vkv Ges e'v#M#Z c#Z'vkv| e'v#M#Z c#v#g#j i#q#Q e'v# v#b#R, Zvi e'v#M#Z P#n`v Ges Zvi e'v#Z#j| t#U#R#j m Gi g#Z e'v#i P#n`v c#Y#i v#R`^#a#b I c#v#c#v#K#Zvi c#Z Zvi c#Z#v#b n#`Q e'v#Z#j| c#Z#v#bK c#v#g#j Ges e'v#M#Z c#v#g#j m#th#M v#`v#q ev #K#v c#Z#v#b b#v#K m#v#v#R#K v#m#÷g M#o I #v| #K#v c#Z#v#b b#v#K m#v#v#R#K v#m#÷#gi Av# Zvq th m#Kj e'v#e#M#ev Kg#e' i#q#Q, Zv#`i e'v#Z#j; P#n`v, c#Z'vkv Ges f#v#Kv c#v`v#b I Kv#R#i ev`#v#q#b m#zKg#e'e'vcbvi g#v`#g A_#n n#q I #v| GK#b Av#Á #K#v c#v#K v#R Av#i Y#K v#q#S#Y K#i#b, m#K#K#j v#b`R c#v#bi ga` v`#q c#Z#v#bi m`m` Z_v Kg#e' i gv#S tc#Yv I Kg#e'ú#v RvM#Z K#i#b Ges c#Z#v#b#K C#v#Z j # AR#bi v`#K G#M#q v#b#q hvb|

mst`qtc ejv hvq, we`'ij tqi fuZ`cxwZ GKUW mybw`'b bmxZgyjv Ges weAvbma`S I MYZmwšK cxwZtZ nlqv evAbxq| tkWYKt`qi eü wk`qv_`f gvtS mevi cÖZ mgvb bRi t`lqv wk`qKt`Ki c`f`q m`e bq| wk`qv_`f`i`K weifbwe`qz`'qz`'tj fVM Kt`i GK GKRb wk`qKt`Ki Avl Zvq b`v`l`Ki`fj wk`qK-QvT m`u`tkP w`fZ `p nq| i`ayZvB bq| M`Ec weifbwe cÖZfv I gb-gvb`tmi wk`qv_`f`i`Rb` GKUW AwZ D`Eg w`gjb t`qT`| GKv`Ww`gK Ges bb-GKv`Ww`gK Df`q t`qT`i w`bq`gZ gj`v`q`bi e`e`v wk`qv_`f`i`K mRvM I mZK`ivLte| KviY Zviv Rvbte th, wk`qKt`i m`v RvM`Z `w`p Zvt`i Dci w`be`x| wk`qK-Aw`f`fveK m`u`tkP mef`c`qv KvhRi w`K nt`Q GuU wk`qv_`f`i` w`b`Rbv Kv`f`Ri Rb` AZ`šI Dc`thwMx|

wk`qK e`e`v`cbv

wk`qv cÖvm`tbi mef`c`qv bvrK` w`K nt`Q wk`qK e`e`v`cbv| GLv`tbB wk`qv cÖvm`tbi mt`z Ab`vb` cÖvm`tbi `y`li e`eavb i`tq`Q| GKRb we`'ij q cÖv`tbi Aax`tb Ggb me wk`qK _v`f`Kb huiv Avb I cvi`wk`Zvq Zui mgK`q| G mKj wk`qKt`K Av`k w`b`R cÖv`tbi t`qT`i ht`ó mveavbZv ev mZK`Zv Aej`w`b Kiv evAbxq| ". . . The zone of acceptance, that is the uncritical adoption of rules and orders from superiors, is much narrower in the case of college teachers than in the case of other types of employees. Procedures and means of communication with the teachers therefore will be different from those of other personnel."³ GLv`tb Kt`j t`Ri wk`qKt`i w`el`tq hv ejv ntq`Q, Zv me `f`ii wk`qKt`i t`qT`iB cÖhvR`| wk`qK I cÖZ`övb cÖv`tbi m`u`K`Two Way Traffic Gi gZ| cÖZ`övb cÖvb wk`qKt`i`K gh`v w`teb| Zv`i`K w`ek`m Kiteb| w`K t`Zgubfvte wk`qKMYI Zv`i` cÖZ`övb cÖv`tbi Dci Av`v ivL`teb, Zv`K m`š`b Kiteb| Df`q Zid t`_t`K Av`v I m`š`tbi Afve AtnZK f`z e`š`v`S Ges D`t`OM I DrK`Evi Rb`f`t`q hv cÖvmb`tK w`ech`i`Ki`tZ eva`|

mnvqK ÷vd e`e`v`cbv

wk`qv cÖZ`övb`i mnvqK ÷v`tdi g`ta` hviv i`tq`Qb, Zviv ntj b:

- (K) **Avdm ÷vd-** cÖvb mnKvix, D`Pgyb mnKvix, w`bggyb mnKvix, w`mvei`qK, UvBw`c`ó cÖ`E`|
- (L) **QvTvevm ÷vd-** Z`E`y`eavqK, mnKvix Z`E`y`eavqK, evew`P, MwW`m`B`cvi, Avqv cÖ`E`|
- (M) **Gg.Gj.Gm.Gm-** `v`iv`qv, gw`ij, m`B`cvi |
- (N) **Ab`vb`-** wk`qv cÖZ`övb, t`j`v`tZ A`tbK mgq N`E`v ev `w`bK w`f`w`E`tZ ivRw`g`x, KvVw`g`x, w`bgR`j`x, B`t`j KiuK w`g`x c`f`w`Z. Kg`e`x, KvR Kt`i _v`f`Kb|

mnvqK ÷vd`i e`e`v`cbvi t`qT`i w`b`w`ij w`LZ w`el`q, w`ij i` cÖZ `w`öcvZ Kiv cÖqvRb:

- cÖZ`w` M`e`ci ÷v`tdi Rb` Kv`f`Ri mybw`'b bmxZgyjv _v`K`tZ nte|
- th th Kv`f`Ri Rb` Aw`K`Zi Dch`š, Zv`K tm Kv`f`Ri `w`q`Zi`w`tZ nte|
- w`bq`gZ KvR Z`E`y`eav`tbi e`e`v`_v`K`tZ nte|

³ L.D. Gupta, Educational Administration, P-70.

ᚦ Ae GW#Kkb

- cōZiU ÷vtdi KivRi h_vh_ gj`vq̄bi e`e`v`_vKtZ nte|
- mevi Rb` KgZwiBi e`e`v`_vKtZ nte| KivR Avb>` KivRi , YMZgvb ewx̄tZ mnvqZv Kti |

we`ij q cōv̄bi c̄q̄ memgq mevi KivR ZĒyeavb Kiv mæe bvl n̄Z c̄v̄i | DĒg nq hw̄ PZz̄^otk̄Yi KgPvix̄`i ZĒyeav̄bi `v̄qZvU tKvb Dch̄^o uk̄q̄t̄Ki Dci b`v`i Kiv hvq| cōZiU ev cōZ M̄t̄ci KgPvix̄i Rb` KgZv̄j Kiv ev Job Description `Zwi K̄ti Zv̄`i t̄K AeinZ Kiv t̄M̄j KgP̄e`e`v̄cbvi KivR Āt̄bK mnR nq| GQvov cōZōv̄bi Kḡm̄ūv`̄bi Rb` m̄ybw̄^o mgq v̄bNĒ `Zwi Kiv c̄q̄vRb|



c̄v̄VĒi gj`vq̄b: 2

A) eū v̄bePbx c̄k̄æ

m̄iWK DĒi v̄b̄t` Rgj-K Aq̄iŪt̄K eĒv̄qZ Kiab| (D`v̄niY: Avcbvi v̄beP̄Z DĒiU K ntj Ḡt̄K (K) eĒv̄qZ Kiab)

1. uk̄q̄v`_P̄e`e`v̄cbvq uk̄q̄v`_P̄`i Rb` A`k` uk̄q̄v̄μg `Zwi i D̄rm t̄Kiv̄iU?
K. t̄k̄iYK̄q̄
L. M̄š̄v̄M̄vi
M. t̄L̄j vi gvV
N. we`ij t̄qi m̄v̄eR̄ c̄v̄i t̄ek |
2. uk̄q̄K-Av̄f̄v̄eK m̄ū̄t̄K̄P̄ meĒc̄q̄v̄ Kvh̄R̄i v̄`K t̄Kiv̄iU?
K. ḠiU uk̄q̄K I Av̄f̄v̄eK̄t̄`i ḡt̄a` D̄rm̄t̄ni m̄Āvi K̄ti
L. uk̄q̄v`_P̄`i AM̄v̄Z Z̄j v̄iS̄Z K̄ti
M. uk̄q̄v`_P̄`i v̄b̄t` R̄bv KivR mnvqZv K̄ti
N. uk̄q̄K̄t̄`i ḡt̄a` m̄t̄PZbZv m̄jō K̄ti |
3. c̄āvb uk̄q̄K Ges Ab`v̄b` uk̄q̄K̄t̄`i ḡv̄t̄S uk̄īf̄c m̄ū̄K̄q̄I qv̄ ev̄Āb̄xq?
K. eŪž gZ
L. GKZidv
M. Df̄q Zidv
N. Dj̄^o m̄ū̄K̄q̄

Av) iP̄b̄v̄q̄j-K c̄k̄æ

1. t̄Kb uk̄q̄v`_P̄K cōZōv̄bi meĒc̄q̄v̄ gj`evb m̄ū̄` ejv nq? uk̄q̄v`_P̄e`e`v̄cbvi t̄q̄t̄i c̄āvb uk̄q̄t̄Ki `v̄qZv̄ej̄j v̄ēt̄k̄iY Kiab|
2. uk̄q̄K e`e`v̄cbv̄t̄K t̄Kb c̄k̄v̄m̄t̄bi meĒc̄q̄v̄ bv̄R̄k̄ v̄`K ejv nq? uk̄q̄K e`e`v̄cbvi v̄ēv̄f̄b̄v̄ K m̄ū̄t̄K̄Av̄t̄j v̄P̄v̄ Kiab|
3. mnvqK ÷vd̄t̄`i e`e`v̄cbvi t̄q̄t̄i t̄Kvb t̄Kvb v̄ēt̄qi cōZ `v̄ōcvZ Kiv c̄q̄vRb?



m̄iWK DĒi

A) 1| N, 2| M, 3| M|

cW 3

Kgpe`e`lcbvi nuzqvi I tKskj

Df`k`

GB cW tk`l Av`cb—

- Kgppe`e`lcbvi tKskj I nuzqvi m`utK`ej tZ cvi`teb Ges
- GKRb uk`qv c`kvmK uk`fv`te nuzqvi ,ij e`envi Ki`teb Zv e`vL`v Ki`tZ cvi`teb|

ce`ZP`cvtV uk`qv`e, uk`qK Ges mnvqK ÷vd e`e`lcbv m`utK`Av`tj vPbv Kiv ntqtQ| GB Av`tj vPbv t`_tK m`yúó tevSv hvq th, Kgppe`e`lcbv Kv`h`m`av`t`bi Rb` GKRb c`Z`ovb c`av`b`K Aek`B `i`k`P`I Av`f`Á ntZ nte| thb`tZb fv`te uzub e`e`lcbv Kv`h` mgvav Ki`tZ cv`ti b bv| Z`tk Aek`B m`vbw`e uk`Qy`Kskj I nuzqvi e`envi Ki`tZ nte|

1. Av`g`iv Rvb e`e`lcbvi Ab`Zg`j`q`nj - To get the best man and to get best out of that best man. ev`leKc`f`q MYZm`sk Ges gv` mgvR e`e`lq c`Z`uU gv`b`j`i`B Zvi e`w`m`E`y Ges thvM`Zv I `q`Zvi m`te`P`P m`xgvq tc`u`veri Av`kvi itqtQ| GKvU uk`qv c`Z`ov`t`bi Kgppe`e` Zv`i `^`^`c`Z`fvi tkI m`xgvq tc`u`veri Rb` KZU`k`z`m`j`h`vM m`vav cv`"Q Zvi Dci c`Z`ov`b`U Dch`y`Zv vbf`P` Kti | Av`tj vPbv t`_tK `úóZ tevSv hvq, evni t`_tK Pvc c`q`vM Kti bq, eis c`Z`uU Kgp`K `Zt`u`Z`fv`te vR vR thvM`Zv e`v`x`i m`j`h`vM Kti v`tZ nte| GvU ZLbB m`e` hLb Ktg`P` cv`itek nq Avb`v`vqK I Drm`vne`"AK| GB cv`itek `Zvi i `v`q`Zi c`Z`ovb c`av`t`bi | Kgp`e` i`tK KvR Kivi `v`x`b`Zv v`tZ nte|

2. uk`qv c`kvm`tki Rb` hv` Aek` c`q`vRb`q Zv nj :

- (K) m`y`i , vbg`p` gv`b`e`K m`utK`P` Z`tk GB gv`b`e`K m`utK`P` gb`E`j` Rvb`tZ nte|
- (L) `Zt`u`Z`fv`te Kgp`m`av`t`bi t`q`t`I tc`u`Yvi , iaz`i m`utK`P`Z`tk I qv`k`d`nvj `v`k`tZ nte| A`_`v` uzub Zvi mnKgp`e` i v`f`Zi Kv`t`Ri tc`u`Yv m`vó Ki`teb|
- (M) Z`tk MYZm`sk i`v`Z c`x`v`Z Av`v`i`Y Ki`tZ nte|
- (N) Kgp`e` i v`f`Zi Av`Z`v`D`b`v`t`bi meiKv m`j`h`vM m`vav uzub m`vó Ki`teb|

3. Z`tk gtb ivL`tZ nte t`kej gv`I KZ ,ij Av`Bb Kv`b`y` c`q`vM Ki`t`j`B fv`j` dj Av`kv Kiv hvq bv| Gi Rb` c`q`vRb m`y`i gv`b`e`K m`utK`P`v`cb| Kv`t`RB, c`Z`ovb c`av`b`K `Av`t`k` c`v`b` I Av`t`k` cij b`l` b`v`Z` cv`i`n`vi Kti m`y` , vbg`p` gv`b`e`K m`utK`P`v`cb`i v`tK` b`Ri v`tZ nte| uk`qv h`w` mgvR cv`ie`Z`f`bi nuzqvi nq, Zv`nt`j` Kgppe`e` t`K Aek`e` `ij`q` Z`_`v` uk`qv c`Z`ov`t`bi m`t`½` GKv`Z`v` ntZ nte| c`Z`ovb c`av`b Ges Kgppe`e` i gv`t`S m`v`v`utK`P` e`v`b`B t`kej GB GKv`Z`v` m`vó Ki`tZ cv`ti |

4. m`v`Z`Kgppe`e`lcbvi Ab`Zg` nuzqvi nt`"Q MYZm`sk i`v`Z c`x`v`Z I `v`f`v`½`| MYZm`sk `v`f`v`½` m`v`b`e`GKRb c`kvmK t`kej c`kvm`KB bb, GKRb tbZvI e`f`U| mevi c`Z`

mgvb ḡ Ges thwM`Zvbnvqx mnKgf`i gvtS ḡvqZ; eEb I mthwM mjev cḡvb MYZvšK ckvmtKi Ab`Zg `ewkó| wbtRi gZvqZ Atb`i Dci Prcvtrv bq, eis mevi gZvgtZi wfvÉtZ wmvšl I Kvhrg MhY, mnKgf`i cĀZ cĀZḡvb cĀvtrbi mšybtvrtai cwiPq enb Kti| MYZvšK cwiřek cĀZḡvtrbi mġzKgf`e`e`rcvri mnvqK| MYZvšK cwiřek ve`vj q cĀvb KZĒ; I ḡgZv mnKgf`i m½ fIM Kti tbb| hvřK ḡvqZ; t`I qv nq, ZvtK ḡvqZ; cvj řbi DcřhwMx KZĒ; Ges ḡgZvI cḡvb Kiv nq|

5. mġzKgf`e`e`rcvri Rb` cĀZḡvb cĀvb Ges Zui mnKgf`i gvtS mġvúK`thgb ḡiaZcy`řZgnb mnKgf`i ci`úřii gvtS mġvúK`Ges mšybtvrtal mgvb ḡiaZcy`ř mnKgf`i ci`úřii gřa` 00 I weřiva cĀZḡvtrbi KvhrgřřK e`vnZ Kti| GB 00- weřiva Govřvri Ab`Zg Dcvq cĀZḡvtrbi mšMVvbK Kivřřgvi mýúó web`vm Ges cĀZvU Kgf` ḡvqZ; I řvgKvi h_vh_ e`vL`v| A_ř cĀZḡvtrbi m`mř`i gřa` AvřřmšúK` Ges KZĒ; ři`li wbařY| KZĒ; ři GB ři wbařYřK c`řmrcvbI ejv hvq| ři wfvÉK c`řmrcvb 0vri mšMVřbi ḡvqZ; Ges Kvhřwř AZ`řl mġ;Lj řvře cvwř Z nřZ cři|

6. KZĒ; ři ři wbařřYi m½ wqšřYi cĀvi mivmwi mšúwKZ| cĀZḡvb cĀvb meġq ḡgZvi AwKvix nřj I Zui cřř GKv cĀZḡvtrbi me KġřvřřK mivmwi wqšřY Kiv mše nq bv| ZřřK GB ḡvqZ; Aaxb`w wmbqi wKQyKġřřř wBKU Ac0 KřřZ nq| řmB m½ GKRB Kġřřř KZRB KġřvřřK wqšřY Křřeb Zvi GKvU w K wbt`Rbv _vKv cĀqvRb| GvU wfvř Kři cĀZḡvb cĀvtrbi Křři cwiřvc I aib Ges Kgf`i thwM`Zv I AwřÁZvi Dci| KřřRB ř`Lv hvř`Q th, DĒg Kġe`e`rcvri Rb`-

7. cĀZḡvtrbi mKj Kġřřř I Kġřvřři gřa` ḡvqZ; I ḡgZvi mġvř`0 eEb GKvřl cĀqvRb| ḡvqZ; I KZře`i GB mġvř`0 eEb cĀZḡvtrbi Kvhřwř mġvř`te mšúv`řb mnvqK|

tbZtZj aviYv

tbZtZj mbvZb aviYvi cŃZ ᄡocvZ KiŃj Argiv t`LŃZ cve tbZZj.nŃQ GKwU mnRvZ ᄡY A_Ń tKvb tKvb gvby tbZv ntqB RbŃq, ZvŃiŃK ᄡZui Kiv hvq bv| G aviYvi AbŃvixŃi gŃZ wKQygvby `jŃK kvmb Kivi gZ PwiiwŃK `eikŃvewj wbtqB RbMŃY KŃib| RbMZfvte KwZcq weŃkl ᄡYi Awakvix e`wŃMYB tbZvi fvqKv cij b KiŃZ mŃg| GB aviYv AbŃvix weŃkl ᄡY h_v- Ávb, KíbvkwŃ, `ah, mnbkxj Zv, `ŃwŃZv Ges gvbwKfvte mŃy`i e`wŃMY tbZv nevi thwM`|

mgŃqi cwieZŃbi mŃ½ tbZtZj mbvZb aviYvI cwieZŃ ntqŃQ| tbZtZj Dci MŃelYv I wŃŃŃfvebvi dtj tbZtZj mbvZb aviYv fŃ ev wŃ_v etj cŃwŃYZ ntqŃQ| AvawŃK aviYv AbŃvix cŃkŃŃY Ges DEg I Av`kŃcŃkvmbK ev cŃwŃZŃwbK tbZvi mŃ½ NwbŃ mnŃhvŃMi gvaŃŃg tbZtZj ᄡYewj ARŃ Ges tbZZj.MVb mŃe| weŃklÁMY `ŃaiŃbi cŃkŃŃYi K_v DŃjL KŃiŃQb- cŃwŃZŃwbK cŃkŃŃY (Institutional Training) Ges KgŃvjxb cŃkŃŃY (On-the-Job Training)| cŃwŃZŃwbK cŃkŃŃYi gvaŃŃg tbZtZj weŃfbŃe ᄡYewj, tbZtZj KvŃewj Ges tKŃkj mŃúŃKŃZwŃĚK Ávb I aviYv RbŃq| KgŃvjxb cŃkŃŃYi dtj ZwŃĚK ÁvbŃK e`enwii K tŃŃŃŃ cŃŃqvŃMi Rb` gvby mŃPŃ nq|

KvŃRB t`Lv hvŃQ th, GKRB AvawŃK tbZv tKej cŃwŃZŃwb cŃvwbB bb, Zui wŃZi AvawŃK tbZtZj ᄡYewj I PwiiwŃK `eikŃŃi cŃZdj b ev AvPiwŃYK cŃkvk Aek`B NUŃZ nŃe| tKvb Ae`ŃŃZB wŃwb GKKfvte wŃR wŃxŃŃŃŃ mevi Dci PwŃŃŃ t`Ńeb bv| A_Ń GKRB AvawŃK tbZv nŃeb MYZwŃŃK iŃwŃZwŃZŃ wekŃmŃ| `Ńji mKŃji mnŃhvŃMZvq wŃwb cŃwŃZŃwbŃK j ŃŃ` ARŃbi w`ŃK GwŃŃŃ wbtq hvŃeb| L.D. Gupta-i gŃZ, "Leadership infact is not something magical or mystical but is a set of skills that people can learn and develop."³

tKej gvŃŃ we`vj q ev cŃwŃZŃwb cŃvwbB th tbZZj.t`Ńeb Zv bq, cŃwŃZŃwb Ab`vb` m`m` h_v Dcva`ŃŃ, mnKvix cŃvwb wŃŃŃK, weŃvŃwŃ cŃvwb, wŃŃŃKgvŃjx cŃZŃŃK B wŃR wŃR cwiŃgŃŃj tbZZj.`ŃŃbi Awakvix| ZŃŃi cŃZŃŃKiB wŃR cwiŃgŃŃj wKQybwŃŃŃ j ŃŃ` Ges wŃR wŃR Avl Zvq tŃvU `j ev Dc`j _vKŃZ cvŃi| GB tŃvU `j ev Dc`j ŃK wŃwŃŃŃ j ŃŃ` awŃZ Kiv ev cŃŃŃŃZ Kivi ga` w`Ńg Zuiw tbZvi fvqKv cij b KŃi _ŃŃKb|

wŃŃŃŃ cŃwŃZŃwb wŃŃŃŃ Argiv `ŃaiŃbi tbZZj.t`LŃZ cvB- (1) AvbŃwŃbK I (2) AbvŃwŃbK| AvbŃwŃbK tbZZj.wbŃŃŃ AvŃŃŃŃ gvaŃŃg ntq _ŃŃK| hvŃ KLbI tKvb KvŃŃY AvbŃwŃbK tbZZj.e`_Ńvq chŃwŃZ nq, ZLb AvbŃwŃbK tbZZj.AvŃŃŃŃ KŃi|

³ L.D. Gupta, Educational Administration, P-89.



cv#VĒi gj`iqb: 1

A) eū ubePbx cġæ

m#WK DĒi ūb#`Rgj-K Aŋiu#K eĒmqZ Kiab| (D`vniY: Avcbvi ube#PZ DĒi#U K ntj G#K (K) eĒmqZ Kiab)

1. Av#K avi Yv Abŋvqx #K f#te tbZ#Zji , Yve#j AR# Kiv hvq?
 K. mnRvZ cġ#i ōviv
 L. tj Lvcovi gva`tg
 M. cġ#ŋ#Yi gva`tg
 N. KgZrciZvi gva`tg|

2. ūb#Pi tKv#U tbZ#Zji ms#vi Avl Ziq c#o?
 K. Kg#m#úv`b
 L. m#y`úK`#cb
 M. c#f#eZ Kiv
 N. D#i`k` ūb#f#Y|

Av) iPb#qj-K cġæ

1. tbZZ#ej #Z #K tevSvq? tbZ#Zji ms#v D#j #ce# G m#ú#K#GK#U m#y#ó avi Yv c#ŋb Kiab| tbZ#Zji mbvZb Ges Av#K avi Yvi g#a` #K cv`#` ūe`g#b?



m#WK DĒi

A) 1| M, 3| M|

cW 2

tbZtZj UvBc ev aib

Df'ik

GB cW tkfI Avcib—

- tbZtZj wefbaUvBc ev aib wefbaUvBc i KiZ cviḡeb I wefbaUvBc i tbZtZj "enkó" Ztj aiZ cviḡeb Ges
- gb-ÉK, mvgmRK I AvPiWYK ḡóKvY t_K tbZtZj e"vL"v c0vb KiZ cviḡeb/

G hver Avtj vPbv t_K cZxqgvb nh th, tbZZj.e"v3i PwiwK Yvej i m½ Nubôfite m"ú3 | ev-keKctf e"v3i PwiwK MVb Ges "enkó" nj e"v3tZj Ab"Zg Drm| t`Lv tM0 wKQywekI tYi AwKvix e"v3MY thM" tbZv etj wefbaUvBc nb h_v- Ávb, cÁv, ḡ-ḡ, mZZv, Kg"úp, DÍxcbv, Drmín, ḡwqZteva, mýi e"v3Z; BZ"v` Y, wj tbZZtK DrmínZ Kti | maviYZ G mKj tYi AwKvix e"v3MY thM" tbZv etj wefbaUvBc nb |

m"ú3ZK wKQyMtelYv t_K tbZvi ḡ AvPiWYK w_Ki cwiPq cvlqv hvq | GKwU misMvibK Df`M (Initiating Structure) Ab"U wefbaUvBc (Consideration) | c0tgv3 tft th Y, wj t`Lv hvq tm, wj nj : (K) wefbaUvBc Df`M MhY; (2) `tj i m`m`i c0Z0tbi wefbaUvBc m"ú3 AskMhY D0yKiY; (M) mnKg` i m½ m"ú3"vcb; (N) cvi`úwi K thMvthvMi m"ú3 w"vÉ`vcb Ges (N) `jxq Kg"v m"ú3K"mKj tK AeinZKiY |

wefbaUvBc-K AvPiYi tft tbZv mnKg` i c0Z mü`q Ges mnvbywZkxj nb | tbZv Ges mnKg` i cvi`úwi K k"vtevtai dtj KvR mnR Ges ZjwSZ nq |

tbZtZj tkw"v"m KiZ wMq ejv ntqt0, "Some one born great, some achieve greatness and others have greatness thrust upon them."

GB Dv3i Avtj vK tbZZtK c0vbZ wZbW tkwYtZ fVM Kiv thtZ cvti:

(K) K`wi k tgvUK tbZv

w"v RbMZfiteB tbZtZj mgýq "enkó"i AwKvix | A_# GB tkwYi tbZv tbZtZj c0qRbxq Yvej wbtqB RbMhY Ktib | Zviv mnRB `tj i m`m`i wFzi tc0Yv m"ú3 KiZ cvtib Ges `tj i Av`v AR#b m"ú3 nb |

ḡ Ae GW#Kkb

PwiwĪK c"Uvb© Ges Abryvixḡi PwiwĪK ḡenkó", Kvhḡej, j ḡ" I DfĪtk"i gay
mḡútkḡ Dci tbZtZji mvdj" ḡbfḡ Kti| ÷Mnj tbZvi tKvb meḡkl ḡenkó"i Dci
ḡiāZj Avḡivc Ktib ḡb|

mgvRZwĒK ḡḡtkvY

mgvRZwĒK ḡḡtkvY Ablyvqx wZwbB tbZv ḡhḡb ḡtji mḡmḡ"i Norm tK eḡtZ cvḡib
Ges Zvḡ"i mḡḡ ḡḡRḡK GKvZḡ Kti tḡLb| ḡtji mḡḡ GKvZḡv ZḡK mggḡḡbi DḡP
Avḡḡb AvḡḡZ Kti hvi dtj wZwb mḡḡR ḡjḡK ḡbqḡY KitZ cvḡib| mgvRZwĒK eḡLḡ
Ablyvqx tbZv ḡtji tmḡUḡḡU Ges Pwvḡv mḡḡR eḡtZ cvḡib Ges ḡjḡK Ggbfvḡe
cwi Pwv Z Ktib hvḡZ mḡḡR Zviv jḡḡ" tḡḡḡvZ cvḡib| mgvRZwĒK ḡḡZ tbZZj: nḡ"Q
tbZv Ges mnKḡḡev ḡtji ḡḡa" cvi ḡḡwĪK Avḡvb-cḡvb| GB Avḡvb-cḡvb ḡtji cḡZw
mḡm" ḡbR ḡbR fvḡKv cvj b Ktib| ḡKḡ cḡZw mḡḡm"i fvḡKvB GKw Aciw tḡK
CḡK| ". . . . Leadership is truly a process of interaction each participant in
the interaction may be said to play a role and these roles must be in some
way differentiated from each other."⁴

AvPiwYK ḡḡtkvY

AvPiwYK ḡḡtkvY tbZvi eḡwḡMZ PwiwĪK ḡenkó" Aḡcḡḡv Zwi ewv"K AvPiḡYi Dci
AvḡKZi ḡiāZj Avḡivc Kiv nḡ| AvPiwYK ḡḡtkvY-

1. tbZv ḡtji mḡḡ Avḡj vPbvḡḡḡb wZ Ges msMVḡbi Rb" j ḡ" ḡbaḡY Ktib|
2. hvḡ"iḡK wZwb tbZZj: tḡb, Zvḡ"i mḡḡ AblyvḡḡbK, Dḡ Ges mḡḡbRbK mḡúKḡMḡo
tZvḡj b|
3. wZwb ḡtji Avkv-AvkvLv, thvM"Zv, kvḡ Ges ḡḡZv mḡúKḡḡ qvḡKdnvj ḡḡKb|

MḡelKḡ"i MḡelYvj ä Zḡ" tḡK AvI KḡqK aiḡbi tbZtZji cwi Pq cvl qv hvḡ| wZer.
tbZZj. Ggb GKwU tbZZj| ÷"Uvm jxwvi (Status Leader) Aciw GKwU DḡvniY|
÷"Uvm jxwvi mḡvaviYZ tbZvi cḡ ḡhḡv tR"ḡZv Ges KZḡZji Dci ḡbfḡ Kti|
Avḡḡḡ"i tḡki ḡKḡḡv cḡZḡvb ḡjḡZ tbZZj: mḡvaviYZfvḡe ÷"Uvm tKw"K| cḡZḡvbi
cḡvb ḡḡḡḡe tḡwḡv ÷vi Aḡev Aaḡḡ ÷"Uvm jxwvi i fvḡKv cvj b Ktib| cḡZḡvb
cḡvḡbi ḡbeḡḡ Avḡ"K Ppvḡḡ etj meḡeḡPZ nḡ| ÷"Uvm jxwvi EaḡZb KZḡḡ KZR.
ḡḡḡḡḡḡ nb|

÷"Uvm jxwviḡK Avḡiv Avḡḡḡḡḡ ev Avḡḡḡḡḡ tbZv ev wW-Rḡj De-Jure tbZv ejḡZ
cwi | wW-Rḡj tbZv AvBbZ ev meavbZ tbZZcḡḡ nb| G Qvovl iḡḡḡḡ De-Facto tbZv|
wW-dḡḡḡḡ tbZv Kvhḡ tbZZj: tḡb| GKRB meḡ"vj q cḡvb ev KḡjḡRi Aaḡḡ KZḡḡ KZR.
ḡḡḡḡḡḡ nb hv AvḡMB ejv nḡḡḡḡ| Zwiḡ th ḡtji mḡḡ KvR Ktib, tm ḡj KZR.

⁴ Gordon, Group Central Leadership, P-51.

ubtqvMc0B nb bv| tmRb`B Zviv `vBwiK c0vb ntj l mWZ`Kvi tbZv bvl ntZ ctib|
mWZ`Kvi whub tbZv, ZvtK ejv nq De-Facto tbZv| W-d`vt±v tbZv ntZ ntj hv c0qvRb,
Zv nj ZvtK `j KZR.M0hYthvM` ntZ nte| WZub hv`i Rb` Ges hv`i m½ KvR
Kiteb, Zviv thb eStZ cvti WZub ewniVMZ tKD bb, WZub Zvt`iB GKRB| Zvntj t`Lv
hv`Q, GKRB ÷`vUvm ev Avdumqvj tbZv W-Rji l ntZ cvtib, Avevi W-d`vt±v l ntZ
ctib| hLb WZub `tj i m½ GKvZf ntq KvR Ktib, mnKg0`i WfZi `jxq tPZbv l
cvi`úwiK k&vtera RvMZ Ktib, ZLb WZub W-d`vt±v tbZv| Avevi hLb AvBbZ
ubtqvMc0B ntq `jtK kvmb Ktib, ev `tj i tKqvi-tUKvi (Care Taker) wnmvte KvR
Ktib, ZLb WZub De-Jure tbZv|

GLvfb wCZer. ev Fatherly Leadership m0útk0WQyejv hvq| mrvaviYZ cwi evti whub
etqvtr`0 ev cwi evi c0vb ZvtKB tbZv wnmvte gvb` Kiv nq| cwi evtii mKj m`m`
ubtkZ0vte Zui KZZj. Ges Avt`k-ubt`R tgb tbb| `tj i c0Z Zui `w0fW½ WQYv
wCZmjyf| WZub ubtRI gtb Ktib cwi evtii etqvtr`0 weavq WZub me0c0v Avbx Ges
WZub hv Ktib Zv cwi evtii g½tj i Rb`B Ktib| Avgv`i w0v c0Z0vb, wjtZI G
aitbi c0Z0vb c0vb itqt0b, hviv ubtRt`itK wCZer. tbZtZj Avakvix etj gtb Ktib|
wCZer. tbZZtK mWZ`Kvi At`W-d`vt±v tbZZj. ejv hvq bv| KviY G aitbi tbZtZj;
tbZvi AvZgvvq AvacZ` Ges `tj i m`m`i tbZvi Dci AvZgvvq wbf0kxj Zv Zvt`i
`vfwek weKvtki c`tK i0x Kti t`q|



cvtVĒi gj`iqb: 2

A) eū ubePbx cĕæ

mĭWK DĒi ubt`Rgj-K AŋiU#K eĒmqZ Kiab | (D`vniY: Avcbri ubePZ DĒiU K ntj GtK (K) eĒmqZ Kiab)

1. tbZvi mvsMvubK Dt`vM ej tZ tKvbuU#K tevSvq?
 - K. Avt`k ubt`R cŏvb
 - L. cvi`úwi K thvMvthv#Mi mjbw`Œ wfiĒ`vcb
 - M. mnvbfwZkxj gtbvfire cŏkŒ
 - N. Dct`k cŏvb|

2. GKRb we`ij q cĕvb tKvb tkŲyi tbZtZji Avl Zvq ctob?
 - K. AvbŋmbK tbZZj.
 - L. K`vni RtgulUK tbZZj.
 - M. Avgj vZwšK tbZZj.
 - N. MYZwšK tbZZj|

3. mgvRZwĒK`wŏtKvY Abjvqx tbZvi tKvb`ewktŏi Dci tbZtZji mvdj`wbfP Kti?
 - K. tbZvi mnRvZ`Yvevj
 - L. tbZvi Ges`tj i gta`cvi`úwi K Av`vb cŏvb
 - M. tbZvi emn`K AvPiY
 - N. tbZvi Avt`k cŏv#bi ŋgZv|

4. wW-d`vt±v (De-Facto) tbZv ej tZ tKvb ai#bi tbZvtK tevSvq?
 - K. whub AvBbZ tbZZcŏB nb
 - L. whub mnRvZ`Yvevj i Őviv tbZZcŏB nb
 - M. whub`j KZR.MŲYthvM`ntq tbZZcŏB nb
 - N. whub etqvtR`ŏ weavq tbZZcŏB nb|

Av) iPbvgj-K cĕæ

1. tbZtZji UvBc ev aib m#ú#K GKwU hy#wbfP I MVbgj-K e^{3e} tck Kiab | Avgt`i we`jq, wj i Rb` tKvb ai#bi tbZtZji cŏqvRb?



mĭWK DĒi

- A) 1| L, 2| M, 3| L, 4| M|

ḡ Ae GW#Kkb

Kiteb| 0ZxqZt 1Z1b mnKg#`i c0Z mü`q Ges mnvb#1Zkxj nteb| Zui Ges mnKg#`i gv#S cvi`úwi K k3v#teva mKj #K 1b0vi m#½` 11qZj;cvj #b D0y Kite|

c`waKvi etj tKD hLb c0Z0vb c0v#bi` 11qZc0B nb, ZLb 1Z1b tmB c`msw# mKj` 11qZj; I KZ#` cjb K#ib Ges 11gZv I c0Zc#E tfvM K#ib| 1Z1b Aaxb`#`i#K Av#`k 1b#`R c0vb K#ib Ges Zv#`i#K 11bqšY I cwiPvjbv K#ib| GLv#b 1Z1b tKejgv# GKRb 1k11v c#vmK, tbZv bb| tbZv nevi Rb` AvZwi³ AvI 1K0j; c0qvRb i#q#Q| Zv nj - mnKg#`i k3v-#vj evmv,` #KwZ. Ges` Zt0Z#Avb#YZ` AR#|

tbZv 1nm#te 1e`vj q c0v#bi , Yvevj

tbZv 1nm#te 1e`vj q c0v#bi , Yvevj Av#j vPbri c0`v#j 11bgvj 1LZ 1el q, 1j 1etePbv Kiv c0qvRb:

- tbZZj;mvavi YZ`#j i AvI Zvq c0qvM Kiv nq|` 1#fveKfv#teB 1e`vj q c0vb GKRb` #j #bZv 1nm#te` #j #K mnv#h` mn#hvmZvi e`vcv#i Kv#Ri fvqKv i#Lb|
- tbZ#Zj; gb`11E#K 1e#k#i#Y tbZvi Rb#MZ` 1#fveK , Yvevj #K c0arb` t`l qv n#q#Q thgb-`ah, #mnbkxj Zv, gv#vmK m#y`i Zv,` #` 1k#Zv, mrvnmKZv BZ`w` |
- tbZ#Zj; mgvRZv1E#K 1e#k#i#Y e`v³ A#c11v cwi#tek I cwi#cwiK#RZvi Dci , i#Zj; Av#ivc Kiv n#q#Q| cwi#cwiK#R Dcv`vb h_v: c0Z0v#bi Kv#Ri gv#Iv, tbZvi` 11Zv, mnKg#`i m#½` m#úK, c0Z0v#bi cwi#tekMZ Ae`v BZ`w`i 0viv tbZvi mvdj` 1ba#i Z nq|
- tbZZj;Ggb GKwU c0#qv thLv#b tbZv`#j i D#i`k` AR# I Kv#m#úv`#b mnvqZv K#ib Ges` #j #K j` 11` AR#bi w`#K GwM#q 1b#q hvb|
- tbZv`#j i m`m#`i AvPi#Yi 11bqšK I c#fveK 1nm#te KvR K#ib|

Dc#iv³ 1el q, 1j #K mvg#b ti#L tbZv 1nm#te 1e`vj q c0v#bi , Yvevj i GKwU Zv#j Kv c0vb Kiv hvq:

- tgvnbxq e`v³Zj
- MYZv#šK` 1#f#w#½`
- Av#Z#cj wä Ges AvZ#c#Z`q
- ` #` 1k#Zv
- M#Zkxj Zv (Dynamism) ev cwi#eZ# tK t#tb tbevi kw³
- mnKg#`i m#½` m#y#úK# cwi`úwi K k3v#teva
- mgm`v tgvKv#ej vi kw³
- mgm`vi mg#q#vPZ mgvav#bi 11gZv
- K_v I Kv#Ri 11qj` (#^0Zv)
- thvM#h#v#Mi` 11Zv
- mgvR gv#b#j i m#½` m#y#úK#

ukfute tbZtZj , Yveij ARB Kiv hvq?

Avgiv Rvb, we`ij q cãvb GKvavti cãvmK Ges tbZv GB Dfquea fvgKv cvj b Kti b/ cãvmK wnmvte Zui`vqZj; we`ij tqi ukŷvi gvfbvbqtb mtpó n l qv/ tbZv wnmvte Zui`vqZj; msukó mKtj i Rb` ukŷvi cwi tek`Zwi Kti t`l qv/ KvtrB ZtkK tbZtZj emãZ , Yveij Aek`B ARB Kitz nte/ wbgvj uLZ we l q, wj i cãZ`wocvZ Kiv thtZ cvti |

1. we`ij q cãvb Zui`xNŷ tbi AvfãZvi Avtj vtK tbZtZj emãZ , Yveij mgr ARB Kiteb |
2. Zui tj Licov, Ávb, l cãvi m½ mnRvZ , Yveij l e`wŷtZj msugkY NwUtq wZwb tbZtZj emãZ , Yveij mgr ARB mtpó nteb |
3. mgq wek t l cãqvRtb ZtkK U`vKwKk ev tKŠkj Aej`b Kitz nte |
4. mnKgŷ`i wFzi h_vh_`vqZj l KZŷ; Acŷ Ges Kvtr i`KwZ. cãv tbi gva`tg tbZtZj , Yveij weKv k mnvqZv Kiteb |
5. ZtkK Aek`B cãkŷY wbtZ nte | AvRtKi cwi emZŷ wek; tbZtZj , Yveij weKv ki Rb` cãkŷYi GKvš cãqvRb |



cvfVvEi gj`iqb- 3

A) eü ubePbx cãæ

mivK DEi wbt`Rgj-K AŷiuUtk eFvqZ Kiab | (D`vniY: Avcbvi ubePZ DEi w K ntj GtK (K) eFvqZ Kiab)

1. tbZv wnmvte we`ij q cãv tbi meŷcŷv , iæZŷv`vqZj tKvbuU?
 - K. `j tK mŷwi Pij bv Kiv
 - L. `j tK mŷ i fite wqšŷ Kiv
 - M. ukŷvi gvfbvbqtb mtpó n l qv
 - N. `tj i mngwZv ARB mŷlg n l qv |
2. tbZv wnmvte cãvb ukŷtKi Ab`Zg , Y tKvbuU?
 - K. Avt`k-wbt`R cãv tbi ŷlgZv
 - L. wqšŷ l cwi Pij tbi ŷlgZv
 - M. mnKgŷ`i AvbMz` ARB i ŷlgZv
 - N. AvBb Kvby cãqvMi ŷlgZv |

Av) iPbvqj-K cãæ

1. tbZv wnmvte cãvb ukŷtKi`vqZj; KZŷ` l , Yveij i GKvU msuŷB cwi wPvZ cãvb Kiab |



mivK DEi

A) 1 | N, 2 | M |

cW 1

umxvšlMhYi A_©, iaZjGes cŕqvRbxqZv

Dt`ik`

GB cW tk`l Avcib—

- umxvšlMhY ej tZ wk tevSvq Zv wj uLZ ev tgšlLKfvte cŕvk Ki tZ cvi teb Ges
- cŕZövb cwi Pvj bvi tŕŕt` umxvšlMhYi , iaZjI cŕqvRbxqZv e`vL`v Ki tZ cvi teb|

umxvšlMhYi A_©

t`tki mmeR wkŕŕv e`e`vi Dbqb, cŕvi ev cwi Pvj bv msvšl mi Kwii umxvšl mrvavi YZ wevfbaAvt`k, ubt`R ev cwi ct`I i gva`tg Avgiv RvbtZ cwi | cŕZömbK chŕqI GKRb cŕZövb cŕvbtK wevfbael tŕq umxvšl MhY Ki tZ nq| we`ij q cwi Pvj bv Ki tZ wMtŕq cŕqk wevfbaev i w`Zi D`e nq hLb umxvšl MhY Acwi nvh`ntŕq cto| umxvšl MhY Ggb GKwU cŕqv hv cŕZövtbi `b w`b KvŕRi Aveŕ`Q` A½| GRb`B ej v nq cŕvm tbi KvR umxvšlMhY w`tŕq i i æntŕq Avevi umxvšlMhYB tkI nq|

we`ij tŕq GKvŕwŕgK gvb Dbqb Ges tm j tŕŕ` cwi Kí bv `Zii Ges ev`évqbcšv ubi fcy; wkŕŕv_ŕ, wkŕŕK, wkŕŕvµg msvšl weI qvej; mncvµwŕgK Kvŕŕevj cwi Pvj bv; EaŕZb KZŕtŕŕi m½ thvMvthvM; mgvŕRi m½ m`ú`Zv I thvMvthvM iŕŕv; tŕŕZ AeKvŕVtŕgvi Dbqb; cixŕŕv cwi Pvj bv; A_ŕwZK e`e`vcbv BZ`w` eúvea tŕŕt` GKRb we`ij q cŕvbtK Anin umxvšlMhY Ki tZ nq| G mKj tKvb tKvb weI tŕq we`ij q cŕvb KLbI GKv umxvšl tbb| Zte AveKvsk tŕŕt` msukw e`w`etMŕ mnthvMzv I gvŕgtZi wfvE tZ umxvšlMhY Kvŕŕmgvav nq| gtb ivL tZ nte mWk Ges hvŕcY`umxvšl Dci cŕZövtbi wevfbaKvŕRi mdj Zv wbfŕ Kti |

wetkl ÁMY umxvšlMhYtK GKwU cŕqv etj DtjL Kti tQb| umxvšlMhYi wFZi w`tŕq cŕZövtbi m`m`i AvPiwYK `evkto`i cwi Pq cvlqv hvq| umxvšl MhY cŕvm tbi meŕcŕŕv , iaZcY`KvR| cŕZövtbi hveZxq KvR umxvšlMhYi Dci wbfŕ Kti |

umxvšlMhYi msAv

cŕZövb cwi Pvj bvi Rb` cŕqvRbxq c`tŕŕc MhY, cwi Kí bv MhY I ev`évqb Ges D`MZ mgm`vej i mgvav tbi wŕvg tE eúvea weKí cšvi ga` t`tK meŕcŕŕv DEg cšvUj m tPZb evQvBtK umxvšlMhY ej v hvq| GB m tPZb I thšw`K evQvB Gi m½ msukw e`w`etMŕ wŕŕŕfvebv Z_v gubwK PŕŕRwZ| umxvšl MhYKvixi gubwK Ges gw`ŕ Pŕŕ mgvšZ iŕŕci evntcŕvk NtU umxvšlMhY cŕqv| KvŕRB umxvšlMhYtK gubwK cŕqvI ej v hvq|

umxvšlMhYi ,iazi cōqvRbqZv

Avtj vPbvi cōitB ejv ntqtQ tKvb tKvb netklÁ umxvšl MhY Ges cōkvm̄tK mgv_℞ etj MY KtītQb| Zuv umxvšl MhYtK cōkvm̄tbi tK>`le>`jZ ṽcb KtītQb| Zt̄i ḡtZ cōkvm̄tbi Abṽb Kvh̄euj umxvšl MhYi Dci w̄fPkyj | netklÁM̄tYi G aītbi ḡZvgZ t̄tK umxvšl MhYi ,iazi Dcj w̄ä Kiv hvq| AvRtKi Dbz̄ netk; hyṽ cYṽm̄xvšlī ,iazi Acwi mxg| tmRbṽB netklÁMY meiKg Z_ m̄útk̄AeMZ ntq cōB Zt̄_i Avtj vtK umxvšl MhYi c̄ŋc̄m̄Z| hyṽ I Z_ mgx umxvšlī t̄ŋt̄ j̄ ŋ̄ I D̄t̄ik̄ ubāt̄Yi ci thvM̄t̄h̄Mi t̄Pb̄b w̄i Kiv nq Ges Ḡt̄K̄ t̄i Ḡt̄K̄ aītbi umxvšl MhYi ṽw̄qZ; AcY Kiv nq| Gf̄v̄te AZṽśl m̄ḡz̄l w̄bq̄gZm̄šK Dcv̄t̄q cōkvm̄tbi KvR Ḡm̄t̄q hvq| w̄e`ij q GK̄uU mvḡm̄RK msM̄Vb| mgv̄t̄Ri c̄Z̄v̄kv I cōB̄ w̄e`ij t̄qi m̄w̄ēR KḡR̄v̄t̄Ūi m̄t̄½ R̄w̄oZ| tmRbṽB umxvšl MhYi Dr̄Kl̄Zv I , YMZ gv̄b GK̄v̄šf̄v̄te K̄vḡ|

hyṽ cYṽm̄xvšlī thgb GK̄uU w̄k̄ŋ̄v̄ cōZ̄v̄t̄K j̄ ŋ̄ AR̄f̄bi w̄ t̄K w̄t̄q hvq, tZ̄ḡv̄f̄v̄te f̄j̄ umxvšl cōZ̄v̄t̄bi Rb̄ m̄gr̄ w̄ec` t̄W̄t̄K Av̄t̄Z̄ cv̄t̄i| w̄h̄ub cōZ̄v̄t̄bi c̄v̄b, Z̄t̄K m̄`w̄mēv̄ G w̄el̄t̄q m̄ZK̄_v̄k̄t̄Z n̄te| m̄w̄WK I hyṽ cYṽm̄xvšlī grāt̄ḡ w̄Z̄ub cōZ̄v̄t̄bi gv̄bexq Ges e`MZ Dcv̄t̄bi m̄t̄ēf̄ēḡ e`envi w̄b̄w̄ōZ̄ K̄īt̄eb Ges cōZ̄v̄t̄K j̄ ŋ̄ AR̄f̄bi w̄ t̄K Ḡm̄t̄q w̄t̄q hv̄t̄eb| umxvšl MhY cōq̄v̄i m̄t̄½ m̄s̄w̄k̄ w̄k̄ŋ̄Ke, Ges ḡv̄t̄b̄w̄Rs K̄ūḡūi Ask̄M̄h̄Y w̄b̄w̄ōZ̄ Kiv w̄e`ij q c̄v̄t̄bi Ab̄Z̄ḡ `w̄qZ̄i| GRb̄ ÷vd K̄v̄D̄w̄Yj Ges ḡv̄t̄b̄w̄Rs K̄ūḡūi m̄f̄v̄q m̄ēt̄h̄s̄ȳZ̄m̄t̄ḡ G m̄útk̄Z̄ GK̄uU m̄ȳb̄w̄i ̄b̄ w̄m̄Z̄gv̄j v̄ c̄ŋ̄q̄b Kiv th̄t̄Z̄ cv̄t̄i| Q̄v̄t̄ f̄v̄Z̄,c̄ix̄ŋ̄v̄ M̄h̄Y, dj̄vdj̄ c̄k̄v̄k̄, w̄k̄ŋ̄K I Ab̄ṽb` KḡP̄v̄īt̄ i w̄ēw̄f̄b̄ēP̄v̄m̄`v̄ c̄īY I mḡM̄ōw̄b̄im̄t̄bi t̄ŋ̄t̄l̄ Z̄j̄or umxvšl MhY ew̄āZ̄ dj̄ et̄q Av̄t̄b| w̄K̄S̄' ḡt̄b̄ i v̄L̄t̄Z̄ n̄te, D̄t̄j̄ w̄L̄Z̄ t̄ŋ̄t̄l̄, w̄j̄ t̄Z̄ c̄v̄b w̄k̄ŋ̄t̄Ki c̄t̄ŋ̄ GK̄v̄ Z̄w̄oN̄w̄o K̄tī umxvšl t̄b̄l̄ qv̄ t̄K̄v̄b̄m̄t̄ḡB K̄vḡ` n̄t̄Z̄ cv̄t̄i v̄|

umxvšl MhY m̄útk̄Z̄ w̄ēw̄f̄b̄ēw̄et̄kl̄t̄Ái ḡZ̄vḡZ̄ w̄et̄kl̄Y K̄it̄j̄ Gi ,iazi h_vh_f̄v̄te Ab̄ḡv̄eb Kiv hvq| m̄v̄B̄ḡb cōkvm̄b̄K `w̄qZ̄; I KvR̄t̄K umxvšl MhY Kv̄V̄t̄ḡv̄i ḡt̄a` t̄īt̄L̄ w̄ēt̄ēP̄bv̄ K̄tīt̄Qb| Z̄ūi ḡt̄Z̄ cōkvm̄b̄K cōq̄v̄i m̄ēŪv̄B̄ umxvšl m̄útk̄Z̄| Gi D̄t̄ik̄` nj̄ `t̄j̄i KvR̄t̄K m̄n̄R̄Z̄i Kivi Rb̄` j̄xq cōP̄v̄t̄K Kv̄R̄ j̄ v̄M̄t̄bv̄| w̄Z̄ub cōZ̄w̄U cōkvm̄b̄K cōq̄v̄t̄KB umxvšl MhYi Avtj vtK e`v̄L̄v̄ K̄tīt̄Qb| t̄dq̄t̄j̄ i w̄b̄q̄š̄Y ev̄ Controlling Gi A_ e`v̄L̄v̄ K̄it̄Z̄ w̄M̄t̄q w̄Z̄ub et̄j̄ t̄Qb, c̄ŋ̄t̄ḡ umxvšlī ,Yv̄, Y w̄b̄Ȳq̄ K̄it̄Z̄ n̄te| AZ̄t̄ci m̄ūJ̄c̄Yṽm̄xvšlī, w̄j̄ m̄s̄t̄k̄v̄ab̄cēR̄ Aaxb̄` m̄n̄Kḡf̄` i mg_ ̄ Av̄`v̄q̄ K̄it̄Z̄ n̄te hv̄t̄Z̄ Z̄ūiv̄ th̄ umxvšl t̄b̄t̄eb, Z̄v̄ th̄b̄ KZ̄ēt̄ŋ̄i umxvšlī m̄t̄½ m̄½w̄Z̄c̄Yṽṽq̄|

w̄j̄ P̄ud̄i (Litchfield) cōkvm̄b̄K cōq̄v̄t̄K GK̄uU w̄ēīv̄U P̄m̄ et̄j̄ Av̄f̄m̄Z̄ K̄tīt̄Qb̄ hv̄i ḡt̄a` Āt̄b̄K, w̄j̄ ŋ̄Z̄`ŋ̄Z̄`P̄m̄ īt̄q̄t̄Q| GB ŋ̄Z̄`P̄m̄, w̄j̄ i cōZ̄`K̄uU GK̄ GK̄uU w̄et̄kl̄ `w̄qZ̄; c̄j̄ t̄bi t̄K̄š̄kj̄ ē n̄w̄Z̄q̄v̄i `t̄f̄c̄| GB P̄m̄ umxvšl MhY w̄ t̄q̄ īiā n̄t̄q̄t̄Q Ges t̄kl̄ n̄t̄q̄t̄Q Reappraisal ev̄, Y w̄ēP̄vi w̄ t̄q̄| Reappraisal Gi Avtj vtK c̄b̄v̄iq̄ umxvšl MhY w̄ t̄q̄ P̄m̄v̄K̄it̄i cōkvm̄b̄K cōq̄v̄i Av̄w̄Z̄Z̄ n̄t̄`Q|

w̄M̄d̄_m (Griffiths) umxvšl MhYt̄K cōkvm̄b̄K cōq̄v̄i t̄K>`le>`jZ cōZ̄`v̄cb K̄tīt̄Qb| ". . . . Griffiths asserted that the decision making process is the central process

of administration and that the central function of administration is directing and controlling the decision-making process.”¹

we`ij q cwi Prj brq wmxvšl Mh̄tYi , iazj I cŋqvRbrxqZv Dcj wä Kfi cŋZw cŋZövb cŋvbŋKB wmxvšlMh̄Y I ev`evqŋbi tŋŋŋ Kkx fvgKv ivLŋZ nŋe|



civVēi gj`vqb: 1

A) eū ubePbx cŋæ

mivK Dēi wbt`Rgj-K AŋiUŋK eŋvqZ Kiab| (D`vniY: Avcbri ubeŋPZ DēiU K ntj GŋK (K) eŋvqZ Kiab)

1. thšv³K wmxvšl ej ŋZ wbtPi tKvbUŋK tevSvq?
 - K. Z` msMh̄, Z` weŋkŋY, weKí cšv hvPvB, gj`vqb
 - L. mgm`v wPwýZKiY, Z` msMh̄ I weŋkŋY, weKí cšv hvPvB, mteŋEg cšv Mh̄Y
 - M. mgm`v wPwýZKiY, Z` weŋkŋY, dj v dj hvPvB, gj`vqb
 - N. mgm`v wPwýZKiY, mgm`v mgvavŋbi weŋfbæcšv D`vneb, dj v dj hvPvB, gj`vqb|
2. tKvb weŋkŋÁ cŋvmbK `vqZj I KvRŋK wmxvšl Mh̄tYi gŋa` tiŋL weŋPbv KŋiŋQb?
 - K. tdqj
 - L. wj Pwŋdì
 - M. mvBgb
 - N. wMŋd_m|
3. tKvb weŋkŋÁ cŋvmbK cŋvqŋK wmxvšlMh̄tYi Pµ etj AvŋvŋZ KŋiŋQb?
 - K. tdqj
 - L. wj Pwŋdì
 - M. mvBgb
 - N. Mŋvj K|

Av) iPbvŋj-K cŋæ

1. wmxvšlMh̄Y ej ŋZ wK tevSvq? D`vni Y mnKvŋi evŋŋq w`b|
2. we`ij q cwi Prj brq wmxvšlMh̄tYi , iazj I cŋqvRbrxqZv e`vL`v Kiab|



mivK Dēi

A) 1| L, 2| M, 3| L|

¹ Roald F. Campbell, Edwin M. Bridges and Raphael O. Nystrand, Introduction to Educational Administration, 5th edition, P-164.

Dctiv³ ckeij i DEi LR tei KitZ cvitj we`ij q cãvibi ctŕ mgm`vi mWK cKuz.
I KviY Rivr mnR nte|

aiv hvK, t`Lv tMj me ukŕv_ŕ BstiuR ukLŕZ Amjeav nt`Q bv| tKej gvĭ KwZcq
wekl ĩvb I wekl cãZõvb t_ŕK AvMZ ukŕv_ŕ i BstiuR ukLŕZ Kó nt`Q| ZLb cke
KitZ nte, ukŕv_ŕ i ceZP`ŕ tKvb cãZŕZ BstiuR tkLvŕbv nZ Ges BstiuRŕZ
Zv`i Ávb I `ŕZvi gvb KZUKZ ukŕv_ŕ i ceZP`ŕ ŕj tZ (A_ŕ th `ŕ t_ŕK
Zviv eZŕvb `ŕj GtmtQ) BstiuR ukŕv_ŕvibi gvb Ges cãZ h_v_ŕI mWK uQj ukbv?
hv` t`Lv hvq th, ceZP`ŕ ŕj tZ tKej gvĭ cVb, ŕj Lb I gly`kw³i Dci ,iazi
t`lqv nZ hv eZŕvb we`ij tŕq Abgŕ`Z Ges eZŕvb we`ij tŕq BstiuR ejtZ civiv,
BstiuRŕZ gtbi K_v cKvik Kiv Ges Communicative Approach of Teaching-tK
(K_vq Av`vb cõvb) Awkzi ,iazi t`lqv nt`Q, Zvntj mgm`uU tgvUvgvU mWKfite
uPuvŕZ ntŕq tMj |

Gi cieZPavtc we`ij q cãvb KZK, ŕj weKí cšv wePvi wektY Kiŕeb:

- (K) uZvb cŕjv mgm`uUB Dŕcŕv KitZ cvtib;
- (L) mgm`v mgvavŕbi Rb` GKvB cõB Zŕ`i mrvh` vbŕZ cvtib;
- (M) mgm`v msuvsŕZ` Zui mnKgŕ` iŕK RivvŕZ cvtib|

cŕg weKí cšmU i tŕŕŕĭ ubuŕvq ejv hvq, GuU mgm`v mgvavŕbi tŕŕŕĭ GKvU tbiZevPK
c`ŕŕc| G aiŕbi c`ŕŕc ev`wofwz MõŕYi gva`tg mgm`vi mgvavb Avkv Kiv hvq bv|
uZxq cšmU i tŕŕŕĭ djvdj fj g` DfqB ntZ cvti| we`ij q cãvb GKv umxvsŕĭvbŕj
nqZev`ŕZ uZvb umxvsŕĭvbŕZ cviteb, Zte cieZŕZ mnKgŕ`i gvŕS weifc cãZuuvq
mŕoi mŕvebv ŕŕK| ZZxq weKí cšmU i tŕŕŕĭ GKv`ŕK uKQv SŕK, Aciv`ŕK mŕj
civi mŕvebv iŕtŕQ| cŕgZt mnKgŕ`i` gtb KitZ cvtib GuU tKvb mgm`vB bq| tKbbv
AvZ AímsL`K ukŕv_ŕGB mgm`vi Avl Zvq cŕo| uZxqZ: Z` chŕj vPbv I mgvavŕb
tcãvŕZ uŕtŕq mnKgŕ`i Ah_v Kvj tŕŕcb KitZ cvtib| Zey GBUKzAvkv Kiv hvq th,
thŕnZZZxq cšmUŕZ mnKgŕ`iŕK umxvsŕĭMõŕYi mŕhvM t`lqv ntŕqŕQ, Zviv GB umxvsŕĭ
ev`evqtb vbŕv` Z cõY nteb| cãZõvb cãvibi Rb` KiYxq nj, uZvb cãZuU weKí cšvi
djvdj uK ntZ cvti Zv Abgŕvŕbi tPov Kiŕeb Ges tKvb cšmUŕK KZUKz, iazi t`ŕeb
Zv ubaŕŕ Y Kiŕeb|

hv` I cãZõvb cãvb vbŕRB Povŕĭumxvsŕĭtŕeb, Z`vnc msukõ e`ir³etMŕ AskMõY mgm`v
ubv`ŕfite mbr³KiŕY mrvqZv Kiŕe Ges u`K vbŕ`Rbv t`ŕe| cõqvRŕb mfv tWŕK uZvb
msukõ e`ir³etMŕ mŕ½ weifbweKí cšv, ŕj mŕúŕK`tLv vLvŕŕ fite Avŕj vPbv Kiŕeb|
Gfite meri mgŕeZ cõPov Ges Avjvc Avŕj vPbv ga` ŕ tŕq mWK umxvsŕĭU tei ntŕq
Avmŕe| GB tŕŕŕĭ cãZõvb cãvb th umxvsŕĭtŕeb, Zv KLbB Zui GKK umxvsŕĭnŕebv,
GuU nte msMVŕbi umxvsŕĭ| "Only after analyzing all of the cues supplied by the
involvement of these various people in the organization, does the chief

administrator make the decision. In a real sense, the decision is an organization one.”²

imxvšlMhYi wefbaevc

Dctiv³ Avtj vPbvi tcltZ imxvšlMhYi wefbaevc, uj AvZ mnRB mbv³ Kiv thZ cvti:

- mgm^{vi} vPvY^Z Ki Y (GLv^tb mgm^{vi} Dcw^v Z tevSv^tbv n^t“0) |
- Z[“] msMh |
- Z[“] we^tk^l Y |
- m^uWK mgm^uU mbv³ Ki Y |
- mgm[“] mgvav^tbi wefbaevc^{Ki} cšvi ch^qj vPbv ev hvPvB evQvBKⁱ Y |
- mgvav^tbi m^te^q cšv[“] we^q ev[“] ba^q Y |
- we^q cšv[“] Kv^hRⁱxⁱ Ki Y ev imxvšl[“] ev[“] v^qb |
- imxvšl[“] Kv^hRⁱmi Zv gj[“] v^qb |

imxvšl tkMveb[“]im

imxvšl m^uu^uK^q Avtj vPbv t[“]k Avgiv imxvšl[“] K thš^v3^K ev Rational Ges Athš^v3^K ev Irrational GB `B[“] fv^tM fv^uM Ki^tZ cwi | GQrov, m^vBg^tbi tk^uY^{Ki}Y Ab^hv^qx Avgiv Programmed ev ubq^ugZ ev i^uub imxvšl Ges Non-Programmed ev Aubq^ugZ ev Auba^hi Z imxvšl[“] cwi Pq cvB | Programmed ev i^uub imxvšl n^t“0 tmB imxvšl hv we[“] vj q c^uv^tk c^uZ^uv[“] cwi Pvj bvi Rb[“] c^uZ^uubqZ Ki^tZ n^t“0 | G RvZxq imxvšl vZ^ub m^vaviYZ we[“] vj qⁱ Rb[“] c^uxZ we^u we^uv[“] ev ubqg Ab^hv^qx Mh^Y K^ti v^tKb | thgb-uk^qK^ti v[“] v^uqZ; e[“]E^b, Kv^k i^uub c^uq^b, cⁱx^qv cwi Pvj bv, mnc^vu^ugK K^uh^qevj cwi Pvj bv BZ[“] | G mKj t^qq[“] Qrov KLb^l KLb^l we[“] vj q Ggb cwi v[“] Zⁱ D[“]e nq, hLb we[“] vj q c^uv^tk Zv^qY^Kfv^te Ri^ux v^uv[“] Z imxvšl Mh^Y Ki^tZ n^tZ cvti | G ai^tbi imxvšl Auba^hi Z imxvšl[“] ch^q c[“]o | D[“]vi^Y t[“]fc ejv thZ cvti Qv[“] Am^tš^l ev em^vu^uMZ m^šv^ut[“] i n^vgj v | GB t^qq[“] we[“] vj q c^uv^tk v[“] v^uqZ v I m^Rb^kv^j Zvi gva[“]tg mgm^{vi} mgvav^tb Gu^uu^q Av^ut[“]Z n^te |

we^tk^l Á^t i gZ^ugZ ch^qj vPbv[“]š^l Avgiv Avⁱ l K^tqK ai^tbi imxvšl[“] m^t½ cwi v^uPZ n^tZ cwi | G[“] vj n^t“0 Muddling Through, Mixed Scanning Ges Aua^KZⁱ Mh^Yth^vM[“] A[“] Ask^x vⁱx imxvšl | Muddling Through imxvšl Mh^Y c^uv[“]Z[“] Z^u v^uv[“]š^l tbb, Zv em^vZj K^tib Ges c^uv[“]q bZb K^ti imxvšl Mh^Y K^tib | G ai^tbi imxvšl Mh^Y m^uev

² Introduction to Educational Administration, P-168.

GB th AbeiZ MhY I ewZtj i dtj mnfRB fŷ imxvšlcwëŷq Averi bZb Kti imxvšl
tblqv hvq| Zte G aiŷbi MhY I ewZj m=úŷ©nvZto chŷq cto Ges G t_ŷK tKvb
fij dj Avkv Kiv hvq bv| Mixe Mixed-Scanning imxvšl MhY cxwZ m=úŷ©thšw³K
Ges nvZto cxwZi ga'eZŷGKwJ cšv| GB cxwZtZ thšw³K Ges nvZto cxwZi mŷeav
Ges fij w`K_ŷj MhY Kiv nq| Askx`vix imxvšl Ggb GK aiŷbi imxvšl hv
we`ij q_ŷj tZ eŷj cŷŷj Z| whub cŷZöŷbi cäv, wZwb th DEg imxvšl MhY Kiteb
Ggb K_v bq| msukó mKtj i mnthwMZvq imxvšl MhY Kitj imxvšl AwKZi e`wbô I
mwMK nevi m=ŷebv _ŷtK|

GK_v gtb ivLtZ nte imxvšl MhŷYi tŷŷtŷ tkI etj tKvb K_v tbB| wkŷŷv wbtq thgb
wbišŷl cixŷŷv wbxŷŷv Ges MŷelYv Pj tZB _vKte, tZgub imxvšl MhY wbtq| cixŷŷv
wbxŷŷv Pj tZB _vKte|



cvtVĚi gj'iqb: 2

A) eū ubePbx cĕæ

mġWK DĚi ūbt`Rgj-K AŋiūU†K eĚvġZ Kiab | (D`vniY: Avcbvi ūbePZ DĚiū K ntj G†K (K) eĚvġZ Kiab)

1. thŠv³K ūm×vš'ūbtPi tKvūUj Dci ūbfP K†i?
 K. Z` msMŋni Dci
 L. Z` ūetk††Yi Dci
 M. ūm×vš'MŋY cġuqvq AbŋZ iŋZ c×ūZi Dci
 N. ūeK† cš† evQvB Gi Dci |

2. ūm×vš'MŋY cġuqvq tKb mgm'v ūetk††Y Kiv cġqvRb?
 K. `ž ūm×vš'Mŋ††Yi Rb`
 L. mn†R mgm'v mgvat†bi Rb`
 M. mgm'vi cKZ.KviY L†R †ei Kivi Rb`
 N. mn†R Z` ūetk††Yi Rb` |

3. ūm×vš'MŋY cġuqvq ūefbæūeK† cš† hvPvB Gi KviY ūK?
 K. mġWK ūm×vš'MŋY mnR nq
 L. mgq Kg j v†M
 M. LiP Kg j v†M
 N. Abiqv†m ūm×vš'††l qv hvq |

Av) iPbvj-K cĕæ

1. D`vniY mnKv†i ūefbæavc D†j LceR ūm×vš'MŋY cġuqv e'vL'v Kiab |
2. ūefbæcKvi ūm×vš'††i D`vniY ū' b |



mġWK DĚi

A) 1 | M, 2 | M, 3 | K |

cW 3

ve`'vj tqi umxvšlMhYi tŋtĭ cāv̄b ukŋtKi fvgKv

Dtĭk

GB cW tkĭl Avcĭb—

- umxvšlMhYi tŋtĭ cāv̄b ukŋtKi fvgKv Dtĭl KiŋZ cviŋeb Ges
- mĭWK l Kvhrĭ umxvšlMhYi tŋtĭ ũZub ũKfvŋe Zui`'vqZ; cvj b Kiŋeb Zv eyŋv l e`vL`v KiŋZ cviŋeb|

GK_v Ab`Kvhŋh, umxvšlMhYi tŋtĭ cāv̄b ukŋtKi Kkĭ Zvi Dci ve`'vj tqi mvdj`' ũbfŋ Kĭ| Avgiv AvŋMB tRŋbuQ mĭWK mgŋq mĭWK umxvšl MhY ve`'vj tqi mKj KvRKŋgŋhgb MĭZ l cŋtYi mĀvi Kĭ, tZgub GKĭU fĭ umxvšl KviŋY ve`'vj tqi mgn`ŋũZ nŋZ cvŋi | thŋZzve`'vj q cāv̄b ve`'vj q cĭvmŋbi kvl`ŋe`'ŋZ Ae`vb Kĭb, umxvšlMhYi tŋtĭ Zui`'ŋZv Ges Kkĭ ZvŋK meŋcŋv AMĭaKvi ũŋZ nŋe|

cāv̄b ukŋtKi fvgKv

t`tki mĭweR ukŋv ũelŋq umxvšlMhYi , iæ`'vqZ; ukŋv gšŋvj tqi Dci b`v`l GKvŋR ukŋv Avā`Bi`'ij ukŋv gšŋvj qŋK mrvqZv Kĭ _vŋK| cĭvZōvbK chŋq umxvšlMhYi tŋtĭ meŋcŋv , iæZcŋe`'vŋ nŋj b cĭZōvb ev ve`'vj q cāv̄b| Zui`'vqZ; umxvšlMhYi Kkĭ Zvi Dci tMũv ve`'vj tqi mvdj`' ũbfŋ Kĭ| ceŋZŋ cvŋV ejv nŋqŋQ, ve`'vj q cāv̄b GKv umxvšlMhY bŋ Kĭ msĭkō mnKgŋ`i mrvqZv l gZvŋZi ũfvĔŋZ umxvšl ũbŋj tmĭU AvāKZi Kvhrĭ ũetevPZ nŋe| cāv̄b ukŋtKĭK gŋb ivLŋZ nŋe umxvšlMhY ve`'vj tqi ũevŋQbŋKvb Nũbv bq| ve`'vj tqi ũevfŋemg`v, NvZcĭZNvZ Ges cvi`ūvi K KvŋRi Avl Zvq GĭU Avēi Z Pj ŋZ _vŋK|

umxvšlMhY hvŋZ thšvŋK l Kvhrĭ nq, tmRb`' cāv̄b ukŋtKĭK KvZcŋ ũel q mĀŋŋKŋŋ ŋ ivLŋZ nŋe| umxvšlMhYi cŋ`vŋ ũZub ũbŋgŋe`' cĭŋe`'ij i cĭZ`'ŋ t`ŋeb:

1. tK umxvšlMhY Kiŋeb?
2. tKvb ũelŋq Dci umxvšlMhY Kiv nŋe?
3. ũKŋmi Dci ũfvĔ Kĭ umxvšl tŋl qv nŋe? (GLvŋb umxvšl MhY msĭkō ũevfŋeZ`' mĀŋŋKŋZub ũPšŋfvebv Kiŋeb)|
4. tKvb cĭvZ Aeŋ`b Kĭ umxvšlMhY Kiv nŋe?
5. umxvšl mĀe`' djvŋj ũK nŋe?

umxvšlMhYi mĭWKZv hvPvB Gi tŋtĭ umxvšlMhY mspvšlGB tPKĭj ÷ ũU cāv̄b ukŋtKi Rb`' mrvqK nŋe|



cvtVĒi gj`vqb: 3

A) eū ubePbx cĕæ

mĭWK DĒi ūbt`Rgj-K AŋiūUĕK eĒvĭqZ Kiab| (D`vniY: Avcbvi ūbePZ DĒiūU K ntj GĕK (K) eĒvĭqZ Kiab)

1. thšv³K I KvĥRi ūm×všĭMĥYKĕĭ cĕvb ūkŋĕKi KiYiq ūK?
 K. mnKgĕ`i mKtji gZvgĕZi ūfiĒĕZ ūm×všĭtbteb
 L. tKejgvĭ ūmūbqi mnKgĕ`i gZvgZ ūetePbv Kiĕeb
 M. Z_`msMĥni Dci ,iæZj`teb
 N. ūm×všĭĭ tPKŭj ÷ AbyiY Kiĕeb|

2. tKvb aiĕbi ūm×všĭMĥYi tŋĕĭ ūkŋKMY AŭaKgvĭvq AvMĥx?
 K. th mKj tŋĕĭ ūm×všĭMĥY AĕcŋvKZ.mnR
 L. th mKj ūm×všĭĭ tŋĕĭ mgq Kg j vtM
 M. th mKj ūm×všĭĭ tŋĕĭ ūkŋKMY tckvMZ Ávb I AŭfÁZvi Ae`vb ivLĕZ cvĕib
 N. th mKj ūm×všĭĭ Rb` Z_`msMĥ AĕcŋvKZ.mnR|

Av) iPbvġj-K cĕæ

1. we`ij tqi ūm×všĭMĥYi tŋĕĭ cĕvb ūkŋĕKi fŭgKv ūeĕkdY Kiab|



mĭWK DĒi

A) 1| N, 2| M|

ewn`K KviY

ewn`K KviY, ij i gta` cto c&vmtb RbM#Yi AskMh#Yi c&qvRbxqZv, RbM#Yi mjeav-
Amjeav m#utK@m#PZbZv Ges `vbxq Ae`v I ivR%buzK P#tci m#t_ b#uz I Kg#Pi
mg#SvZvKiY BZ`w` | Gme weiq t`#K D`mZ mgm`v, ij m#aviYZ `vbxqfvteB m#jvrv
Kivi c&qvRb nq| G mKj t#t#` #lgZv we#Kw` KiY Qvov tKvbiKg Dcvq `v#K bv|

eisj v`tki ik#lv c&vmb: tKw`fZ bv we#Kw`fZ?

Avgt`i ik#lv c&vmtb mtePP I me#bg#ch#q chS#we#fb#e#vc ev`li it#tQ| Avgt`i
gva`igK ik#lv c&vmtbi c&Z `w#cvZ Kitj Avgiv #bg#j #LZ c&vmtbK `li m#r t`L#Z
cvB|

eisj v`tki gva`igK ik#lv c&vmb

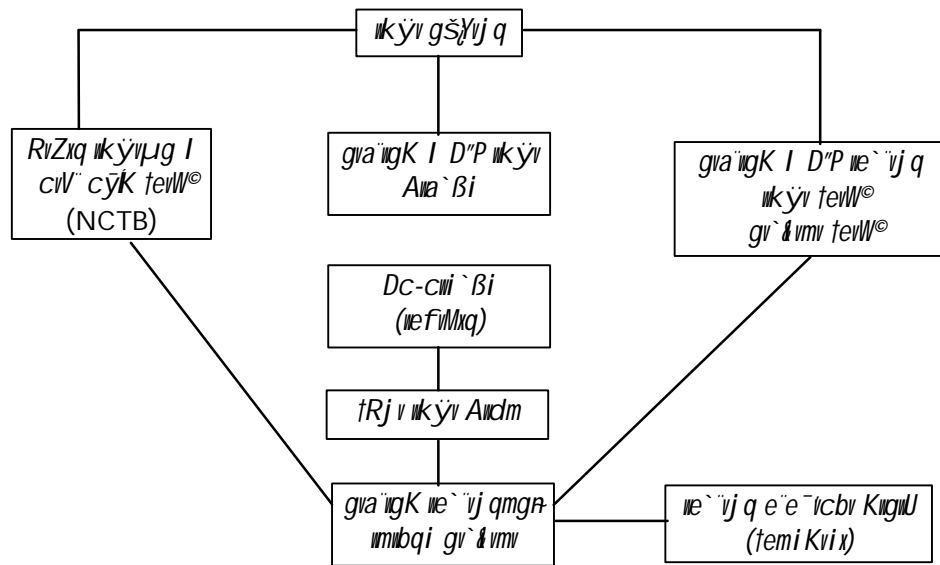

Avgt`i t`tki gva`igK ik#lv c&vmb tKw`fZ bv we#Kw`fZ Zv w`i KitZ ntj
Avgt`i t`L#Z nte ik#lv m#u#KZ we#fb#e#lgZv c&vmtbi tKvb `li c&qvM KitQ| ik#lv
cwi K#i bv Ges ik#lv ev#RU #K c#q#b KitQ? Gme ik#lv gS#y#j qB c#q#b I Kv#Rix
K#i | GRb` tKvb tKvb mgq we#kl tKvb ms`v Mv# Kiv ntj I Zv ik#lv gS#y#j t#iB
#bq#t#Y KvR K#i `v#K| cv`m#P I ik#lv#ug c#q#b, cyK c&vkvb I mieivn BZ`w`
KvRl ik#lv gS#y#j t#i #bq#y#v#x#b RvZxq ik#lv#ug I cv`cyK teW`K#i `v#K| K`vWvi
m#v#m (ik#lv) c&Z#bi ci c&vmtbi EaZb `v#qZc#`c` m#r ntZ mnKvix c#v#b ik#lvK
chS#c`m#r#n t#vK #b#q#vM, PvK#i we#v# BZ`w` me#KQ# K#i ik#lv gS#y#j q| Zv ntj t`Lv
h#t`Q th c&q me #lgZvB gS#y#j q mi#v#v#i A`ev A#x#b` Ab`v#` m#P ms`v I cwi`B#i i
gva`igB c&qvM K#i `v#K| Ggb#K we#fb#e`ij t#i M#U-Bb-GBW, ik#lv fvZv, D`Pzi
ik#lv#i Rb` AvMvg teZb e#x# BZ`w` th mKj KvR G h#v#Z wefv#xq cwi`B#i i `v#qZj
#Qj tm me KvR AvRKij XvKv` Av#Bi i A#t#b #b#q h#l qv nt#tQ| ZvB wefv#xq ik#lv
cwi`Bi t`#K Av#K#i #bg#Zg `li chS#we#fb#e#c&vmtbK avc, ij i`ay`b#`b i`#U#b

ᄡ Ae GW#Kkb

KvRB Kti hv"Q| Gme wePbv Kti t`Lv hvq evsjv`tki gva`igK uk9lv ckvmb
tKw`fZ uk9lv ckvmbiB DrKó.D`vniY|

wbtagc0É PttU©c0_igK uk9lv ckvmb KvVtgvv c0Z j9 Ki+j I t`Lv hvq mtePP uk9lv
gš9lv q t_+K mefbgame`vj q chšfA+K,uj`li itqtQ|

evsjv`tki c0_igK uk9lv ckvmb

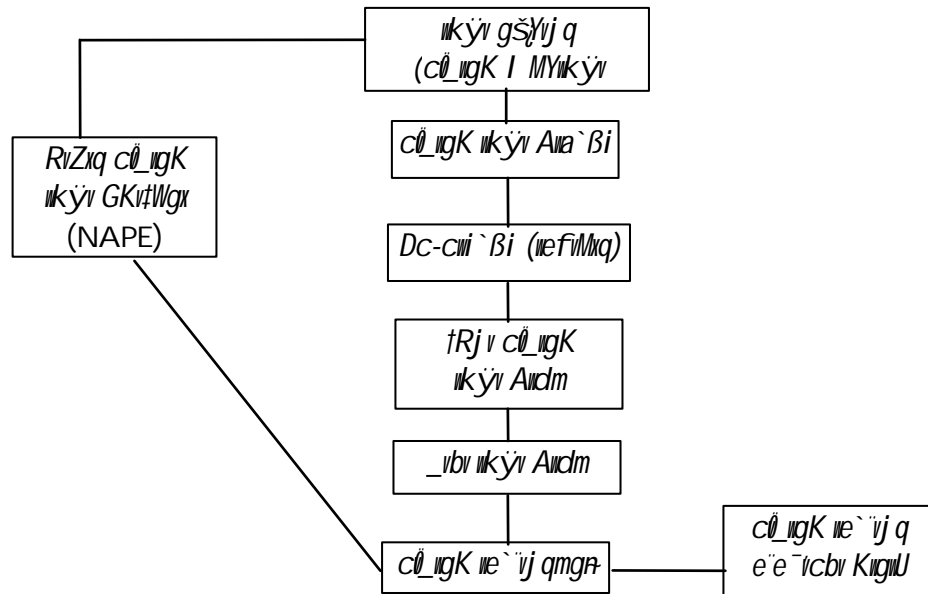

GLv+bl gj- 9lgZv uk9lv gš9lv q I c0_igK uk9lv Awa`BtiB mxgve×| gva`igK uk9lv
gZ c0_igK uk9lv t9t+I evtRU c0_igK, cwiKibv I c0_igK c0_igK, cvV`mup I uk9lv
c0_igK, cvW`cyK c0_igK I mieivn, ckvmbi EaYzb`ti tjvK wbtqvm I Zvt`i PvKwi
weva c0_igK BZ`v` mKj 9lgZvB c0_igK ev ctiv9lv fite uk9lv gš9lv tqi nvtZ| G Ae`v
wePbv Kti AwaKzi 9lgZv weKw`Ki+Yi j+9 1981 mvtj GK Aa`v`tk ZrKvj b
gnKgv ch9q`vbxq`ᄡ KZE9 Mvb Kivi K_v uQj| cieZ9 ch9q ckvmbK 9lgZv
weKw`KiY Kiv ntj beMvZ DctRjv cwiI`+KB`vbxq c0_igK uk9lv`vqZ; Ac9
Kivi K_v w`i Kiv nq| ukS`DctRjv cwiI`mgn AvR chšfh_vh_fite MvZ bv nl qitZ
G e`e`v mWK ifc cwiMh Ki+Z cvi+Q bv| G Kvi+Y c0_igK uk9lv ckvmb GLbl euj
c0_igK weKw`KiY h_vh_fite msNvUZ ntZ cvi+Q bv|



cv#VĚi gj`vqb: 1

A) eū ubePbx cĕœ

m#WK DĚi ubt`Rgj-K Aŋiu#K eĚv#qZ Kiab| (D`vniY: Avcbvi ubeP#Z DĚi#U K ntj G#K (K) eĚv#qZ Kiab)

1. tKv#U we#K#`fZ cĕv#tbi `enkó?
 - K. Aa`b Avdm KZR.Dci`Avd#mi #m#vš#KvhRixKiY
 - L. ŋgZv cĕv#tbi m#eP#`#i b`KiY
 - M. ŋgZv`vbxq KZ#t#ŋi #bKU b`KiY
 - N. tK#`# #m#vš#ev ubt`#ki Rb` cZ#ŋvKiY|

2. P#j # I q#_# g#Z we#K#`Ki#Yi c#vb Dcv`vb tKv#U?
 - K. #m#vš#M#Y
 - L. cĕv#b
 - M. mgm`v tgvK#tej vKiY
 - N. `v#qZ;Ac#|

3. tKv#U ŋgZv we#K#`KiY#K Ac#i nvh#K#i tZvtj?
 - K. EaY#b KZ#t#ŋi #bKU `vq#Zv
 - L. `#Z Kvh#m#úv`#bi Pvc
 - M. RvZxq H#K`i c#qvRb
 - N. GKB iKg b#vZi c#qvRb|

Av) ms#ŋ#B DĚi cĕœ

1. tK#`fZ cĕv#b ej #Z #K tev#vq?
2. tK#`KiY-we#K#`Ki#Yi m#t_ #m#vš#M#Y ŋgZvi m#úK#Ki#?
3. tK#`KiY-we#K#`KiY #ba#ŋ#Yi t#ŋ#ŋ` , i#Z#Y#KviY, #jv #K?
4. cĕv#b we#K#`Ki#Yi e#v#K KviY, #jv #K?



m#WK DĚi

A) 1| M, 2| K, 3| L|

cW 2

ტკუ`ფZ ცკუმტი მუეავ-ამუეავ

დტიკ

GB cW tkʼl Avicib—

- ტკუ`ფZ ცკუმტი მუეავ eYᅇv KiʼZ cviʼeb Ges
- ტკუ`ფZ ცკუმტი ამუეავ Dʼj ᅇ KiʼZ cviʼeb|

ფიგკv

ტკvb ტკvb ტʼʼᅇ thgb Riʼai Kvj ᅇb Ae`vq ev Dbᅇbgj-K KgRvʼU ტკუ`ფZ ცკუმტი i f cʼve j ᅇ Kʼi AʼbʼK Gi ᅇ iazʼK EʼaYʼZʼj aʼiʼQb, Avevi AʼbʼK GʼK GKU MYZwšK t`ʼki cʼvmb e`e`vq Agʼj Ki bq etj AwfgZ wʼtqʼQb| Gʼʼᅇ UʼKwʼfʼj i (De Tocqueville) gšᅇu j ᅇYʼq| wZub Zui eʼʼte` ტკუ`ფZ e`e`vi RqMvbl tMʼqʼQb, mʼt_ mʼt_ Avevi mgvʼj vPbvI Kʼi tMʼQb| Zui gʼZ kwʼKvj x ტკუ`ფZ e`e`v e`ZxZ Rvzi DbwZ I cʼwZ mʼᅇ bq Ges Rvzi Aw`Zj| wʼtK `vKʼZ cviʼi bv| Avevi GI mZ` th ტკუ`ფZ ცკუმბ RvziʼK `ᅇᅇ KiʼZI mgwaK mʼʼg| “Indeed I can not conceive that a nation can live and prosper without a powerful centralization of government. But I am of opinion that a centralized administration is fit only to enervate the nation in which it exists by incessantly diminishing their local spirit” Avgiv eZᅇvb cviʼv ტკუ`KiʼYi, wʼtkI Kʼi wʼqʼv cʼvmb ტკუ`KiʼYi მუეავ-ამუეავ mʼuʼKʼRvbʼZ tPov Kie|

ტკუ`ფZ ცკუმტი მუეავ

ტკუ`ფZ wʼqʼv cʼvmbi ტʼʼᅇ wbgw ᅇLZ მუეავ, wj i K_v Dʼj ᅇ Kiv hʼq:

1. RvZxq wʼqʼvbwZ wbaʼY

wʼqʼv GKU RvZxq ᅇ iazʼcʼwʼelq| G wʼlʼq ZvB GKB RvZxq bwZ MᅇY tMvUv Rvzi `w_ B cʼqʼRb| ტკvb ტკvb ტʼʼᅇ wʼqʼvʼK RvZxq HʼK`i evnb wnmvʼte t`Lv nq| RvZxq HʼK`i `w_ RvZxq wʼqʼvbwZ wbaʼY Kiv ტკუ`ფZ wʼqʼv cʼvmbi cʼʼB mnR| Kvi Y ტკუ`ფZ wʼqʼv cʼvmbB miv t`ʼki wʼqʼvi GKgvʼ wqšK I G wʼlʼq GKgvʼ wmxvš MᅇYKvi x|

2. ᅇwʼetiva wimb

ტკუ`ფZ wʼqʼv cʼvmb wʼqʼv wʼlqK mKj ᅇgZv GK Ges mʼᅇPP `ʼi `vʼK| dʼj cʼvmbK HK` wbuʼZ nq| tK>`a I AĀʼj ev wʼwʼbᅇAĀʼj i gʼa` bwZ wbaʼY I tmme KivRixKiʼY gZwʼZvi AeKvK Lᅇ Kg| ᅇgZvi Avl Zv I GLwZqvi wʼtqI wᅇgZ ev wʼetivʼai ტკvb AeKvK `vʼK bv| ᅇgZv GK tKʼ>`a `vʼK etj ტკუ`ფZ ცკუმბ mKj A`uóZv, ᅇwʼetiva I Sʼtʼgj v gʼ|

3. mgšq mab

čkvmibK th tKvb KvřR AřbK KgřZř I Awdm ři RwoZ _vřK| h_vh_ řiře KvřR mřuv řbi Rb` msukó mKřj i gřa` KvřRi mřvgšq ččqvRb| GKwU kvl`čvbxq tK`^řt_řK G KvřR tek mnR nq| AZGe tKw`řZ ukřřv čkymb G e`vcři mřeav`vex KiřZ čři|

4. `ř cwi Kři bv I umřvřřMřY

tKw`řZ ukřřv čkymb `řZřv I AwiřÁZřvmgř| KviY Avřvř`i gZ Dbařbkřj ř`řk weřkIÁ-`řZřvi řřZřřnZzřv čvl qvl e`qmvā e`vcři| ř`kř-weř`kř weřkIřÁi čivgk` iayřKř`ř čřřB čvl qv mře| řK`^Qvov AvřÁwř K Awdmřgřř ZřB weřkIřÁi NvUwř t_řK hvq| AZGe, GKgvř tKw`řZ ukřřv čkymbB `ř I AwiřÁ weřkIřÁi čivgk`řbřq DĚg čři I cwi Kři bv čřqb Ges umřvřřMřřY mřřg|

5. e`q mřřKřPb

tKw`řZ ukřřv čkymb umřvřřMřřY I ZrmřuvřKř KvřR iayřKw`ř Awdm KgřZřřvB RwoZ| Zřiv mřL`vq Kg| GKB řřb KgřZ řj řgYřvřv, gnvNřřvřv řřZ nq bv| Ab`řřK čkymb weřKw`řZ řřj Ae`v`řvřq AřbK Awdm, AřbK řřvK, Avmeřecř BZ`ř | Zřv tKw`řZ ukřřv čkymb Zřřvřj-Křře e`q mřřKřPb nq|

6. čřřegř čkymb

čkymbři Dci AřbK mgq břbv řř_ř řřvK I řMvřx t_řK Pvc Avřm Zřř`i čřř umřvřřMřřY Kivřbvi Rb`| tKw`řZ čkymbř tK`^křvřřkřj x _řK weavq AřbK řřřř Zřiv Pvc čřřřřřř mřřg| tKw`řZ ukřřv čkymb AřbřKi břMřřj i evřři řřj I Zřiv weřřbře ivR`břřZK, mřgvřřK, e`emřvřK, AvřÁwř K, řřbxq I Ab`řb` řMvřxi Přřci evřři _vKřZ čři|

7. `řZ umřvřřMřřY

tKw`řZ ukřřv čkymb `řZ umřvřřřbřř mřřg| Kg řřvřKi mřř_ Avřřvřbv KiřZ nq řřj Ges tKw`řZ čkymbři tK`^řřki ivRavřřř _vKřv weřřbřeaiřbi mřeav řřřM Kři řřj `řZ umřvřřMřřY KiřZ čři|

tKw`řZ čkymbři Amřeav

tKw`řKiY e`e`vi řřU-weřřřZ mřřřřK`řWřřW Uřřřřři Břřřř gřě` nj th, G e`e`řvq`řq`řvřřřř řři Amřbxq gvřřvq`čřKZ.nq řřj mřKUKřřj Přřci gřř ařřm čřo| "... A centralised administration heaping on itself intolerable measure of responsibility, invites collapse in periods of stress." tKw`řZ čkymbři Avř I KřřKřU Amřeav mřřřřK`GLřřb Dřřř Kiv nj |

1. řřmřg`břřř j`Nb

mř`ř čkymbři Rb` weřřbřečřřmK I čkvmibK řři gřa` řřmřg` eřřv ivřv GKřřř AvěK`K| řřmřg` eřřv řřřLB čkymbř `řZřv I břřřřřřřřř iřřv Kiv hvq| čkymbř řřmřg` řřř weřřbřeAwdm I KgřZřř GřK Ab`řK čřř`ř ev čřivřřřřře řbqřř ev ivk

tUtb aiv#KB eSvq| G e'e-v _vKtj tKDB Lvq#Lqvj xCY@I `vqZnxb uKQyKti emtZ
citi bv| tKw`fZ uk#lv ckvmtb , iaZCY@GB fvimvg"bwnZ j w-NZ nq|

2. t^QvPwi Zv

ckvmtb fvimvg" bwnZ j w-NZ nq etj tKw`fZ uk#lv ckvmtb t^QvPwi Zv t`Lv t`qvi
Avk#v t`#K hvq| G ai#bi ckvmtb gyt#gq tjvKtK `t`#K wmv#s#vbtZ nq etj Ges
wmv#s#vAb"vb"t`i ct#l Aek" gvb" etj G AvksKv Avi I tefo hvq|

3. AMYZw#s#KZv

tKw`fZ uk#lv ckvmtb RbMt#Yi cZ"l ev ctiv#l AskM#Y wbu#Z bq| G ai#bi
ckvmtb mvaviYZ Avgj vZt#j EaY#b m`m"iVB wmv#s#v M#Y Kti _vtK| Rbc#Zubwiv
`#GKRb _vKtj I Zvt`i cl#vb" _vtK bv, SvbyAvgj viv wewfb#K#tKStj Zvt`i Dci
cl#vb" w#i Kti wmv#s#vPwctq w#tZ m#lg nq|

4. GKtctk ev Ac#qvRbxq wmv#s#v

tKw`fZ uk#lv ckvmtb mKj wmv#s#v tK#`t`#K tbqv nq| t`tki wewfb#AA#tj mvgw#RK
mvs`wZK wewfb#Zv _vtK| tK#`e#m gyt#gq ckvmt#Ki ct#l wewfb#AA#tj i mKj L#vbwU
Z` Rvbr me mgq m#e bq| G Kvi#Y tKw`q wmv#s#v m#WK I mte#Eg bv| ntZ citi |
iayZvB bq, ckvmt#t`i m#iRwgb Awf#Zv bv _vKtj G ai#bi wmv#s#v tKvb tKvb mgq
GKtctk ev Ac#qvRbxq Ggb uk #lvZKi I ntZ citi |

5. RvZxq A#b#K"i m#p

tKw`fZ uk#lv ckvmtbi tKvb bwnZ I wmv#s#v t^QvPv#gj-K I AMYZw#s#K ntj I Ges
RbMY Zv cO` bv Kitj I Zv Zvt`i Dci tPtc e#m| Avevi G ai#bi ckvmtb t`tki
wewfb#AA#tj i mvgw#RK-mvs`wZK cv`R" wetePbv bv Kti mKtj i Rb" GKB bwnZ wba#wi Z
nq etj wewfb#AA#tj i tjvK Zvt#K wewfb#E#te M#Y Kti _vtK| GtZ AA#tj AA#tj Ges
tK#`I AA#tj f# eSv#s m#p i m#tebv _vtK| dtj tKw`fZ uk#lv ckvmtb RvZxq
A#b#K" m#p i AeKvk _vtK|

6. jvj wdzvi t`SivZ#

mg`l #lgZv tKw`fZ etj tK#`i Dci Kv#Ri Pvc tewk _vtK| ZvB wewfb#wel#q
cl#qvRbxq wmv#s#v M#Y I wbt`R cl#vb wj #^N#U| dtj tKw`fZ uk#lv ckvmtb jvj
wdzvi t`SivZ#tefo hvq| Gi mv#_ h# `b#Z thwM nq Zvntj RbMt#Yi `#L `#Rvi Avi
m#gv _vtK bv|

7. `Zt#Z#m#thwMZvi Afve

tKw`fZ uk#lv ckvmtb Aa`b Awdm_#j iaytK#`i wbt`RgZ KvR Kti | Zviv tKvb
Kv#R D#`wM M#Y KitZ citi bv| mKj Kv#Ri Rb" Zviv tK#`i Dci GKv#s#v#teB
wbf#kxj, dtj tKw`fZ uk#lv ckvmtb `vbxq Awdm#g#ni Kv#Ri `v#xbZv _vtKbv|
GRb" A#bK mgq tKw`q wmv#s#v ev `evq#b Zviv `Zt#Z#m#thwMZv wbt#q GwM#q Av#m
bv|

8. TãlcY@m×všŷi mætebv

ejv nŷq _vŷK th tKw`fZ ukŷv cŷvmb `ãZ um×všŷi ubŷZ mŷŷg nq| KviY G weŷq tK>`ŷK Aŷb`i gŷvŷcŷŷx nŷq _vKŷZ nq bv| ukŠ`ev`ŷe `ãZ um×všŷi me v`ŷKi LjŷbŷvU mKj weŷq mŷvKfŷŷe weŷePbvq AvbŷZ mŷŷg nq bv| dtj tKw`fZ ukŷv cŷvmbŷbi KŷvZ `ãZ um×všŷiãvšŷŷt_ŷK thŷZ cvŷi |

cvŷVvËi gj`vqb: 2



A) eü ubePbx cŷæ

mŷvK DËi ubŷ`Rgj-K AŷŷiUŷK eËvŷqZ Kiab| (D`vniY: Avcbvi ubeŷPZ DËiU K ntj GŷK (K) eËvŷqZ Kiab)

1. tKw`fZ cŷvmbŷ j vj wdzvi t`ŠivZŷteto hvq tKb?
 K. mKj um×všŷŷtK>`ãt_ŷK tbi qv nq etj
 L. cŷŷvRbxq um×všŷŷMŷY I ubŷ`R cŷvŷb wej æ`NŷU etj
 M. fvi mvq` bŷvZ j v`NZ nq etj
 N. `ZtÛZ@mŷthvMZvi Afve _vŷK etj |
2. tKw`fZ cŷvmb bŷbv `ŷ_P tj vK I tMvŷi Pŷŷci evBŷi _vŷK etj tKŷvU mæ nq?
 K. cŷfveqŷ cŷvmb
 L. `ãZ um×všŷŷMŷY
 M. Ø>`-weŷiva vbi mb
 N. e`q mŷŷKvPb|
3. tKw`fZ cŷvmbŷ t`QvPvni Zv t`Lv t`qvi Avk¼v _vŷK tKb?
 K. SvbyAvqj viv um×všŷŷMŷY Kŷi etj
 L. ivR%bŷvZK, mvqŷvRK ev bŷbv tMvŷxi Pŷŷci evBŷi _vŷK etj
 M. tK>`ã`bŷvZgŷ bq etj
 N. tKŷ`ŷ um×všŷŷAb`vŷŷ`i cŷŷŷ Aek`gvb` etj |

Av) msŷŷŷB DËi cŷæ

1. tKw`fZ cŷvmbŷ e`q mŷŷKvPb nq tKb?
2. tKw`fZ cŷvmbŷ `ŷŷ cŷi Kŷi bv I um×všŷŷMŷY mæ nq tKb?
3. tKw`fZ cŷvmbŷi cãvb KŷqKŷv Amŷæavi Dŷj L Kiab|



mŷvK DËi

A) 1| L, 2| K, 3| N|

~vbxq Kvhŋ q,uj kw³kvj x ntq I tV| GtZ miKvfi Kgrw³ I `ŋZv ewx cvq| Avi I cwi ~vi fiŋe ej tZ tMtj "It removes the danger of apoplexy at the top and anaemia at the extremities." A_ŋ tK>tk mbvm tivM t_ŋK Ges cŹŠš Kvhŋ q,uj tK i³kbZvi wec` t_ŋK iŋv Kti |

4. jvj wdZvi t`šivZŋnm

weŋKw`Kiŋi dtj tKt`i Kvr thgb Ktg hvq tZgb cŹZ`Kw AAj tK i aybR Gj vKvi KvŋRi ~vqZi cvj b KiŋZ nq etj Zvt`i I Kvr Kg_vŋK| m×všš MŋY I ev`ēvqŋbi Kvr cto_vŋK bv| dtj cŋvmtb jvj wdZvi t`šivZŋ Ktg hvq| `bŋZI Kgvi m×vebv_vŋK|

5. bwiZK kw³ I gŋvej ewx

weŋKw`fZ wkŋv cŋvmtb ŋgZv cŹqvm I ~vqZi cvj tB AvĀwj K KgPviŋ`i ~vaxbZv_vŋK| Zviv wR`^Dŋ`vŋM Kvr KiŋZ cvŋi | Aŋb`i gŋvŋcŋx ntq_vŋKZ nq bv| KvŋRi I Dŋ`vŋMi ~vaxbZv Ges AAj m×vŋKŹ mŋiRwgb Avb AvĀwj K KgPviŋ`i bwiZK kw³, AvZŋm×ŋb I gŋvej ewx Kti |

6. mvgwRK AMŋwZ

ŋgZv weŋKw`KiY mvgwRK AMŋwZ ZjvšZ Kti_vŋK| bvMwi KMYŋK cŋvmtbK wŋvqKjvŋc cixŋv-wbixŋv Kivi mŋhvM wŋq_vŋK| dtj bvbviKg mRbKxj cŹZvi weKvk NŋU_vŋK| weŋKw`KiY thgb weŋfbwms`vi ev GKŋKi cixŋv-wbixŋvŋK mnRZi Kti_vŋK, tZgwb Gŋ`i wŋRŋ`i gŋa`~ŋ`Ki cŹZŋvMZvi I mŋhvM cŹvb Kti_vŋK|

weŋKw`fZ wkŋv cŋvmtbi Amŋvav

cŋvmtbK e`e`v wŋŋŋte weŋKw`KiY GŋKevŋi mij I μwŋgŷ mgvavb bq| weŋKw`KiY ivR%bwiZK Av`k`wŋŋŋte i f weŋwPZ nŋj I ev`ēŋŋŋŋ GwU KZ,uj Amŋvav mŋo Kti_vŋK| Gme Amŋvav cŋŋ½ GLb Avgiv Avŋj vPbv Kie|

1. RvZxq bwiZ wbaŋŋY cŹZeÜKZv

weŋKw`fZ wkŋv cŋvmtb ŋgZv AAj mgŋŋi wBKU n`všŋi Z_vŋK| weŋfbwAAj Zvt`i wŋRŋ`i weŋPbv gZ bwiZ wbaŋŋY Kti | ZvtZ bvbv wfbwZv I `ewPŋ mŋo nq| A_P GKUv RvZi Rxeŋb wkŋvbwZ I cwi Kŋbvi ,iaZj Acwi mŋg| wKQyiwKQyielq AvŋQ thLvŋb RvZxq ~ŋ_B mgMŋŋ`ŋki Rb` GKB bwiZ I KgŋwP cŹqvRb nq| weŋKw`fZ wkŋv cŋvmtb RvZxq Rxeŋb G aiŋbi cŹqvRb wŋUvŋZ mŋŋg bq| Awakš AvĀwj KZv I mskxY© gŋbvfiŋei gZ AŋbK AcŹqvRbxq I ŋwZKi mgm`vi mŋo KiŋZ cvŋi |

2. mgštqi Afve

weifbæAAj wBR wBR wetq ᶿaxb| wefKw`fZ wkᶿv cᶿvmb Zviv iay`xq ᶿᶿ_ᶿ Abᶿj
KgᶿP MᶿY Kᶿi ᶿvK, weifbæAvĀwj K KgᶿP I Kgᶿxwzi gᶿa` mgštqi Afve
cwi jwᶿZ nq| Kvi Y GK_v meRbMᶿn` tKw`ᶿ ms`v Qvov Ab` Kvi I cᶿᶿ GKvR Kiv
mnR bq|

3. A`ᶿ I SᶿKcYᶿKgᶿP

wefKw`KiY ZLbB mdj I mv_ᶿ nᶿZ cᶿᶿi hLb AvĀwj K Kvᶿᶿ q, wj ᶿZ `ᶿ I AwfĀ
tjvᶿtK tKvb Afve ᶿvK bv| cwi Kᶿi bv cᶿᶿq I Zv ev`ᶿvq eo RwJ I tUKwK`ij
KvR| AwfĀZv bv ᶿvKᶿ, wefKĀ bv nᶿj G KvR mgvav Kiv KwB nᶿq `wvq| Avᶿᶿ i
gZ Dbᶿbkj t`ᶿk wefKĀi tek Afve itᶿᶿQ| Gᶿ i teZb I Ab`vb` `vexl tewk|
GKgvĀ tKᶿ`ᶿ cᶿᶿB nqZ AwfĀ tjvK I D`Pe`ᶿq t`kx wef`kx wefKĀ i vLv mᶿe nᶿZ
cᶿᶿi, AvĀwj K ms`vi cᶿᶿ bq| ZvB AvĀwj K ms`v KZᶿ. MᶿxZ cwi Kᶿi bv I KgᶿP
A`ᶿ I SᶿKcYᶿnevi Avkᶿv ᶿvK|

4. tMᶿx`ᶿ_ᶿ wKvi

AvĀwj K ms`v, tjv mKᶿj i nᶿZi KvᶿQB ᶿvK| G, tjv tKᶿ`ᶿ gZ AZ`ᶿi bq, AZ
kwᶿkvj xl bq| Avevi tKᶿ`ᶿ gZ weifbæ`ᶿ_ᶿ I tMᶿxi Pvc t`ᶿK cᶿZi ᶿvi Dcvq|
Zvᶿ i Kg| ZvB `vbxq cᶿvmb mnᶿRB kwᶿgvb tMᶿx I `ᶿj i Pᶿci wkKᶿi cwi YZ nᶿZ
cᶿᶿi | G Kvi ᶿY wefKw`fZ wkᶿv cᶿvmb AᶿB mgq Rb`ᶿ_ᶿ cwi eᶿZᶿᶿMᶿx`ᶿ_ᶿ KvR
KiᶿZ eva` nq|

5. e`ᶿeuj

wefKw`fZ wkᶿv cᶿvmb gvᶿb GK tKᶿ`ᶿ cwi eᶿZᶿeuj tKᶿ`ᶿ; euj Awdm Ges euj Kgᶿvix|
Gᶿ i Rb` `iKvi AᶿB UvKv, teZb fivZv, Ni fivov, tᶿkbrvix LiP BZ`w | AZGe
wefKw`fZ wkᶿv cᶿvmb `ᶿveZB GKwU e`ᶿeuj KvR|

6. wej wZ wmxvš

RvZxq Rxeᶿb AᶿB mgq bvbv Riᶿi mgm`v t`Lv t`q| AᶿB mgq RvZxq AMᶿwzi `ᶿ_ᶿ
Riᶿi wfiEᶿZ KgᶿP MᶿY Kiv `iKvi nᶿq cᶿo| wefKw`fZ wkᶿv cᶿvmb G aiᶿbi
cwi w`wZ tgvKᶿejv KiᶿZ mg`nq bv| Kvi Y ᶿᶿgZv I `wqZi AᶿB tKᶿ`ᶿ wef`ᶿ_ᶿ ᶿvK
eᶿj Zvᶿ i mKj ᶿK `ᶿZ KvᶿR Dᶿy Kᶿi, Avᶿj vPbv Kᶿi cwi Kᶿi bv MᶿY Kiv mnR nq bv|

figKv

cĕvimbK űqvkj vtc KZĖjAcŲ (Delegation) GKűU eĭj Avtj űPZ űelq| th tKvb
 epr msMVtb cĕqkB KZĖjAcŲ ev n`lšfi ntZ t`Lv hvq| űlž` msMVtb űlgZv
 űefvRtbi (Division of Labour) ev KZĖjAcŲyi cĕqvRbxqZv Ly GKUv tbB
 ej tjb Ptj | űKš` msMVbűU hűr űekvjvKvi aviY Kti űKsev Zvi cűiűa űe`lZ jvf
 Ki tZ _vtK ZLb KZĖjAcŲyi űelqűU űižcŲnűq I tV| KviY, űekvj msMVtbi
 KYűvi űntmte GKRB e`ir³ ev űU KtqK e`ir³ i cűű mKj űelűq űm×všlMűY Kiv I
 Zv ev`ĕvqb Kiv Am^{ae} nűq cűo| KLbB me űelűq űm×všlMűY Kiv `xNűvj aűi Zvi
 cűű m^{ae} nq bv| dj kűZtZ, KZĖ`i műt_ űlgZv I `űqZj Aek`B űefvRZ nűq
 cűo| KZĖjAcŲB nj tmB űlgZv I `űqZj eĖtbi DchŲ Dcvq ev gűa`g| űekvj
 GKűU msMVtb ZrciZvi műt_ cĕvimb Kvh^oPij vtZ ntj I msvMvbK DbűZ űeavb
 Ki tZ ntj tmLvtb Aek`B KZĖjAcŲ e`e`vi cĕqvM ev Abűri Y _vKte|

GB BDibtU KZĖjAcŲyi űefvRbűr K m^{au}tK^{avi} Yv cĕvtbi j tűű űZbűU cvV műbĕk
 Kiv nűqűQ| cvV űtj v nj űbgűc:

cvV- 1: KZĖjAcŲyi msÁv I tűvűefvM

cvV- 2: KZĖjAcŲyi műeav, cĕZeűKZv I bűvZgij v

cvV- 3: `vbxq űkűűv KZĖtűűi figKv

cW 1

KZŹ;AcŸyi msÁv I tkŸvefM

DŹik

GB cW tkŹI AvcŸb—

- KZŹ;AcŸ ej ŹZ ŸK tevSvq Zv ej ŹZ cviŹeb;
- KZŹ;AcŸ I veŹKŸ`KiŹyi gŹa` cv_Ź` ŸbŸfcY KiŹZ cviŹeb Ges
- KZŹ;AcŸyi tkŸvefM DŹj L KiŹZ cviŹeb|

KZŹ;AcŸyi msÁv

GKŸU ve`Z.I RŸUj msMVbŹK `ŸŸZvi mŹ_ KvR KiŹZ nŹj tmLvŹb KZŹ;ev ŸŸgZv AcŸyi cŸŸqvRbxqZv Ź`Lv Ź`q| ŹKvb msmVŹbi EaŸŹb KgŹŹŹ KZŹ. Aa`b KgŸvixŹ`i gŹa` KihŸmŹuv`Źbi cŸŸqvRbxq `ŸŸqZj I ŸŸgZv AcŸ Kivi cŸŸZŹK KZŹ; AcŸ ejv nq| gŸŸ (Mooney)i fvlvq KZŹ;AcŸ nj EaŸŹb KZŹŸ KZŹ. Aa`b KZŹŹŸi ŸbKU mŸŸw`Ÿ ŸKQyKZŹ; AcŸ| "Delegation means conferring of specified authority from a higher to a lower authority." Gi dŹj Aa`b KgŹŹŹev KgŸvix Zvi ŸbKU n`ŹŹŹi Z ŸŸgZv cŸŸqM ev ŹfvM Kivi AvBbMZ AbŸŸZ cŸŸ nb hŸ I ŸZŸb EaŸŹb KZŹŹŸi AaxŹb ZLb KgŸZ `vŹKb| ŹUŸi (G.R. Terry) Aek` gŸŸ-i e`vL`vi mŹ_ ŸfvbŸZ ŹcvlY KŹib| ŹUŸi-i gŹZ KZŹ;AcŸ nj ŸŸGK ŸbeŸŸ ev msMVb-BDŸbU nŹZ Ab` Avi GK ŸbeŸŸ ev msMVb-BDŸbŹUi ŸbKU KZŹ; cŸŸvb| "Delegation means conferring authority from one executive or organisation unit to another."

msMVŹbi KZŹ;AcŸ KvŸŹ cŸŸvŸbK bŸŸZgŸj vi ŸŸbqŸŸ cŸŸvŸŸ (Span of Control) bŸŸZ AbŸŸi Y KŹi PŹj | KZŹ;AcŸyi A`GB bq th AcŸKvix KZŹŹŸi cŸŸ Ź`ŹK mKj `ŸŸqZj Z`M Kiv nŹŹŹQ ev PŸvŹŹ ŸŸgZv n`ŹŹŹi Kiv nŹŹŹQ| cŸŸZ.AŹ`KZŹ; AcŸyi ŹŸŸŹ KZŹ;AcŸKvix KZcŸŸ ZŸi ŸŸgZv I `ŸŸŹŹj ŸKQyŸw`Ÿ Ask AcŸ KŹi `vŹKb| ŸZŸb ZŸi AaxŹb KZŹ;MŸŸYKvix KZŹŹŸK cŸŸ`kŸ, ZŸŸŸŸ, ŸbqŸŸ Ges chŸŸŸŸŸi ŸŸgZv aŹi ivŹLb| Ggb ŸK ŸZŸb ZŸi KZŹ;AcŸ th ŹKvb mgq evŸZj ev cŸŸ`vŸvi KŹi ŸbŹZ cvŹib Ges ŸbŹRi nŹŹZ cŸŸivq mg`Ź ŸŸgZv b`ŹKŹZ cvŹib| KvŹRB KZŹ;AcŸyi `ŸŸ `evkŸ`j ŸŸ Kiv hvq| GKŸU nj, EaŸŹb KZcŸŸ ŸbŹRi B`QvŸŸvqŸ th ŹKvb KvŹŸŸ `ŸŸqZj Aa`b KZŹŹŸi ŸbKU b`ŹKiv Ges AcŸŸU nj Aa`b KZŹŹŸK ZŸŸŸŸ I cŸŸ`kŸ Kiv|

KZŹ;AcŸ I veŹKŸ`KiŹyi gŹa` cv_Ź`

veŹKŸ`KiY I KZŹ;AcŸ AvcŸZ`ŸŹZ GKB iKg etj gŹb nŹj I DŸŹŹi gŹa` hŹ_Ÿ cv_Ź` iŹŹŹQ| Aek` GB cv_Ź`ŸU cŸŸi gŸŸMZ| veŹKŸ`KiY nj KihŸmŹuv`Źbi Rb` ŸŸgZvi cŸŸn`ŹŹŹi KiY| Avi KZŹ;AcŸ nj ŸŸgZv ev `ŸŸŹŹj ŸKQyŸw`Ÿ AŹŹki

n`lsh`KiY| A`r GLv#b Aa`b KZE`q EaYzb KZE`qji G#R#U ev c#Zubwa int#mte
KivR K#i _#K| EaYzb KZE`q Aa`b KZE`qji Dci #b#`R I Av#`k Rvix Kivi I
#m#v#s#c#b#cix`qv Kivi `qgZv mKj mgqB #ti iv#L| m#t`q#c ejv nq, "What is
ceded is merely functions and not authority and responsibility." m#Zivs
#e#K#v`KiY nj KZE;Ac# A#c`qv tenk `qgZv I `#qZ;Ac#|

KZE;Ac#Yi tk#ief#M

KZE;Ac# iayEaYzb KZE`qji #bKU t`#K Aa`b KZE`qji #bKU nq bv, #bg#e`li
t`#K D`P`#i KZE`qji #bKUI n#Z cv#i, Avei mg`#i KZE`qji g#a`l n#Z
cv#i| m#Zivs KZE;Ac# #Zb tk#Yi n#Z cv#i, h_v (1) #bg#f#g#x (Downward),
(2) DaY#f#g#x (Upward) Ges (3) cvk#f#g#x (Sideward)| #bg#f#g#x KZE;
Ac#Yi t`q#I EaYzb KZE`q #bg#z#b KZE`qji #bKU KZE;Ac# K#i _#K, thgb
c#v#b #k`qK Zui Aaxb`I mnKvix c#v#b #k`q#Ki #bKU KZE;Ac# K#i b| EaY#f#g#x
KZE;Ac# ej#Z e#v#q #bg#z#b KZE`q KZR. Zui EaYzb KZE`qji #bKU KZE;
Ac#, thgb- #k`qKe, Z#i KZE; #k`qK m#q#Zi mfv#v#Zi #bKU Ac# K#i
_#Kb| cvk#f#g#x KZE;Ac#Yi tejvq KZE;mgch#qi KZE`qji g#a`n`lsh`Z
n#q _#K, thgb A#a`B#i i Dc-c#i P#j K c#k#v#b-Gi KZE;Dc-c#i P#j K c#k`qY-Gi
#bKU Ac#|

KZE;Ac#K gv#v ev c#i gvYMZ #`K t`#K I K#qK#U tk#Y#Z f#M Kiv hvq| G, #j v
nj, (1) Avb#v#bK ev Abv#v#bK (Formal or Informal), (2) c#Y`ev Avs#kK (Full
or Partial), (3) kZ#axb ev #btkZ` (Conditional or Unconditional) Ges (4)
c#Z`q ev ga`eZ# (Direct or Intermediate)| Avb#v#bK KZE;Ac#Yi t`q#I KZE;
Ac# m#v#K#Z #e#a, c#e#a I Av#`kv#v#j #j #LZ AvK#i m#b#ek Kiv n#q _#K|
c`qv#s#i Abv#v#bK KZE;Ac# c#v#j Z ix#Z, c#v# I mg#Siv#v#i #f#E#Z msN#U#Z n#q
_#K| EaYzb KZE`q hLb tKvb Aa`b KZE`q#K Ggbfv#te KZE;Ac# K#i th
Aa`b KZE`q tKvb Kvh#v#v`b, P#v#m#v#v`b ev Av#`vc Av#`j vPbvi c#Y`qgZvi c#q#v#M
Ki#Z m`qg nq, ZLb Zv#K c#Y`KZE;Ac# ejv n#q _#K| #K#` Aa`b KZE`q#K
h#` Kvh#v#v`b, P#v#m#v#v`b ev Av#`j vPbvi tKvb ch#q EaYzb KZE`qji Dc#`k I
#b#`Rbv M#t#Yi Rb` `vq#x _vK#Z nq, ZLb Avs#kK KZE;Ac# Kiv n#q#Q etj
Av#`v#Z Kiv hvq| KZE;Ac# kZ#axb nq hLb Aaxb`I KZE`qji #v#qvKj vc EaYzb
KZE`qji ch#e`qY I Ab#gv`#bi A#c`qv#axb _#K| #K#` Aaxb`I KZE`q h#` Zvi
#v#qvKj vc tKvbiKg msi`qY e`#v#Zi#K#B g#fv#te m#v#v`b Ki#Z cv#i, ZLb Zv#K
#btkZ`KZE;Ac# ejv n#q _#K| c#Z`q KZE;Ac#Yi t`q#I KZE;Ac# m#v#K#Z
c`q `#U#i gv#S tKvb ZZ#q c`q ev e`#v# _#K bv ev n`#`q#c K#i bv| ga`eZ#KZE;
Ac# K`#Pr n#q _#K| Av#`v`i t`#k RbM#Yi t#fv#U #be#P#Z mism`MY KZR.
c#v#bg#s# I iv#c#v#b #be#P#b Gi c#k#v#b.D`vniY|



cvřVĚi gj`ıqb: 1

A) eü ıbePbx cřke

mıWK DĚi ıbt`Rgj-K AřııUřK eĚııqZ Kiab | (D`vııY: Avcbri ıbePZ DĚiıU K ntj GřK **(K)** eĚııqZ Kiab)

1. gıb-i gřZ KZĚj.Acř ej řZ ıK tevřıq?
 K. řıgZvi cřř`ıřı KiY
 L. mıbıř`ı ıKQyřıgZı Acř
 M. GK ıbeřıx KZR.Ab` ıbeřıxřK řıgZı cüıv
 N. GK BDıbu KZR.Ab` BDıbuřK řıgZı cüıv |
2. KZĚj.Acř řKıv cřıvımbK bııZgıj v Abyrı Y Křı?
 K. kř ıefıRb bııZ
 L. Avř`řki HK` bııZ
 M. ıbqřı cıııa bııZ
 N. mgřı bııZ |
3. řKıv `řjı ıeÁıv ıefıřıMi cřıv Zıı KZĚj.MııYZ ıefıřıMi cřıřı bıKU Acř Kiřıb | GıU řKıv aıřı KZĚj.Acř?
 K. cıııřıgıx
 L. Eaııřıgıx
 M. cř`řı
 N. AbıvımbK |
4. KZĚj.Acř KLB kZřııb nq?
 K. Eaıřıb KZĚřı Dcř`k I ıbt`Rbv Mřıřı Rb` `vqex `vKřı
 L. KZĚj.Acřııı ıeıa, cřıııa I Avř`kveııı ııı ıLZ Avıřııı `vKřı
 M. KZĚj.Acřııı řıřıřı `ıı cřıřııı gıřS řKıv ZZıq cřı ev e`ııı `vKřı
 N. KZĚj.Acř cřıııı Z ıııı, cüıı I mgřSıřııı ıřıııřı nřı `vKřı |

Av) msıřıB DĚi cřke

1. řUıı-i gřZ KZĚj.Acř ej řZ ıK tevřıq?
2. KZĚj.Acřııı `eıııı` ıK ıK?
3. KZĚj.Acř I ıeřKıı`Kiřııı gřa` cı`R` ıK?
4. gıřıı ev cııı gııııı ıı K ř`řK KZĚj.Acřııı řkııııefııı, řıı v eııııı Kiab |



mıWK DĚi

A) 1 | L, 2 | M, 3 | K, 4 | K |

cW 2

KZZj:AcfYi mjev, cZeÜKZv I bWZgvj v

Dt'ik"

GB cW tkfI Avicb—

- KZZj:AcfYi mjev, tjv eYØv KiTZ cvi teb;
- KZZj:AcfYi t'fjT wei vRZ cZeÜKZv, tjv DtjL KiTZ cvi teb Ges
- KZZj:AcfYi KtqKvU mvari Y bWZ DtjL KiTZ cvi teb|

KZZj:AcfYi mjevamgr

1. KvhRix tbZZj.

KZZj:Acf e'e-v _vKvi dtj mSMVtbi gE" cKvMk Zuü Aaxb-ñ'i nvtZ Kg
_iaZcY°w elq, wj ev KvhRij tQto w`TZ cvi teb| dj kñZTZ wZvb cävb cävb
_iaZcY°w elq, wj tZ Mfxi gtbvthvM, mgq I kv³ wbtqvM KiTZ cvi teb| GtZ
cKvMvMk KvhRij `fjZvi mvt_ cvi Pvj Z I mæúw`Z nTZ cvi Ges mvt_ mvt_
KvhRix tbZZj| Mto I tV|

2. wKfjvMZ gj"

DbZ KZZj:Acf e'e-vi wei vU wKfjvMZ gj" itqtQ| th tKvb mSMVtbi cvi Pvj tKi
cävb `wqZ;nj, Zuü Aaxb-ñ'i `Zwi Kti tZvjv, `wqZMñtYi wKí Kjvq wKwffjZ Kiv
Ges wmvšf MñtYi DcthvMx Kti tZvjv| GKgvI KZZj:AcfYi gva`tgB GiU ARØ
Kiv mæe| KZZj:Acf Aaxb-ñ'i `bWZK gtbvej Ges AvZñekjm ep× Kti Ges
Kvhñæúv`tb Zvt`i evowZ tçØYv I Drmiv thvMvq|

3. Kwfb`i gta" bgbxqZv

KZZj:Acf e'e-v Øviv KtVvi weiæx cxwzi gta" bgbxqZv Avbqb Kiv mæe ntq
vtK| cvi w`wzi cØqvRb Abymti KZZj:Acf cØwj Z cxwzi mvt mgfSvZv KiTZ
mnvqZv Kti _vtK|

4. `fjZv I wZe`wqZv

KZZj:Acf wmvšf MñY I Kvhñæúv`tb wej æ^nm Kti Ges KZ:mgñtK KvhRix,
wZe`qx I `fj Kti tZvtj| KZZj:Acf I kß wei vRtbi dtj B G, tjv mæe ntq
_vtK| KZZj:Acf mSMVtbi `fjZv ARØ AZ`šf mnvqK| Kvi Y, Gi ØvivB mSMVtbi
gta" `j MZ msnwZ I Ašf ½ mL`Zv jvf Kiv mæe ntq _vtK|

KZĚ;AcĚyi cĚZeÜKZv

KZĚ;AcĚyi tĚĚĚ KZK,uj cĚZeÜKZv t`Lv wĚZ cvĚi th,tjv cĚvbZ `B aiĚbi nĚq _vĚK, thgb- mvsMvĚbK cĚZeÜKZv Ges e`w³MZ cĚZeÜKZv|

mvsMvĚbK cĚZeÜKZv

mvsMvĚbK cĚZeÜKZv bvbvřĚ t`Lv wĚZ cvĚi| cĚgZ, tKvb mvsMvĚb cĚZwĚZ c_xwZ I KvhĚĚj xi Afve _vKĚj KZĚ;AcĚyi Kvr mnR I Zi wšZ nĚZ cvĚi bv| wĚZxqZ, mgšĚ I thvMřthvM gva`ġi Afve _vKĚj I KZĚ;AcĚyi cĚ_ cĚZeÜKZv mġ nĚq _vĚK| ZZxqZ, msMvĚbi AvKvi I Ae`vbi KZĚ;AcĚyi cĚ_ GKwU cĚZeÜK| mvsMvĚb ep`vKvi Ges AĚj wřĚK wĚ`Z.bv nĚj KZĚ;AcĚyi wĚl qwU wĚtkl , iĚġ;ciq bv Ges AcĚyi KvrwU mnR nq bv| G,tjv Qvov AvI GKwU wĚl q KZĚ;AcĚyi cĚZeÜK wntmĚ Kvr KĚi _vĚK| tKvb tKvb cĚvmĚKi exġj- aviYv _vĚK th, KZĚ;wbĚRi nĚZ aĚi bv ivLĚj mgMĚmsMvĚbU LÜ-wĚLÜ nĚq hvĚ| D`PZi cĚvmKĚi ġtb GB aiĚbi Pġ thvM`ZvĚeva Ges Aaxb`Ě`i thvM`Zv mĚúĚK®mskq KZĚ;AcĚyi cĚ_ GKwU wĚc³⁄₄bK cĚZeÜK|

e`w³MZ cĚZeÜKZv

e`w³MZ KviYI KZĚ;AcĚyi cĚ_ cĚZeÜKZv mġ KĚi _vĚK| Gme e`w³MZ KviY,tjv nj h_vġġg- KZĚ;ĚK aĚi ivLĚZ AvZcĚksmv, RbMĚyi `wġi mvgġb wĚ`gvb _vKvi Ges mg`lvKQy Rb` ab`ev` I cĚksmv cvl qvi tbkv, Aaxb`Ě`i cĚĚ t_ĚK AvbM`Z`nxbZvi fq, mnřthvMĚ`i ewx I thvM`Zv mĚúĚK®Av`vi Afve Ges RbMY I D`PZi KZĚ;ĚĚi wĚbKU Revew wĚZv I `vqexZvi fq BZ`w |

Dchř mvsMvĚbK I e`w³MZ wĚl qvewj KZĚ;AcĚyi cĚ_ cĚZeÜKZv mġ KĚj I th tKD wĚbtĚ`tn `ĚKvi KĚtb th, msMvĚb `ĚĚv ewx I MvZKvj Zv Avbqġbi Rb` KZĚ;AcĚyi e`e`v _vKv evĚbřq| G Rb` KZĚ;AcĚyi cĚ_ D³ evav wĚcĚĚ,tjvĚK h_vmĚĚ `ĚřZ Kiv cĚqvRb|

KZĚ;AcĚyi bwxZġvj v

KZĚ;AcĚyi h_vh_ cwi KĚi bv cĚvmĚbi Kvg` Dbqġ Avbqġ KĚZ mrvh` KĚi _vĚK| KĚĚRB KZĚ;AcĚ hvĚZ KvhŘi I mv_Ř nq tmw`ĚK wĚtkl `wġ t`qv cĚqvRb| KZĚ;AcĚyi tĚĚĚ wĚbřġc wKQybĚw`Ě mvari Y bwxZ Abyři Y Kiv evĚbřq|

- KZĚ;AcĚĚ mġbw`Ě I wj wLZ nI qv DvPZ|
- AwcĚ KZĚ;Ěj ġvĚv ev cwi ġvY, KZĚ; cĚqvĚMi bwxZ, wġġ-Kvbly I KvhĚĚj x mġúóřĚ Dġj wLZ nI qv DvPZ hvĚZ AwcĚ KZĚ;Ěj e`vL`vi e`vcĚĚi msMvĚbi ġĚa` mgġġcZv I ġ%ZK` wĚ`gvb _vĚK|
- KZĚ;AcĚĚ wĚbKUZġ Aa`Ěbi Dci AwcĚ nI qv DvPZ| wĚbKUZġ Aa`b e`w³ĚK ġwġġ ev wġwġġġ Ab` tKvb e`w³i wĚbKU KZĚ;AcĚĚ Kiv nĚj D³ wĚbKUZġ Aa`b e`w³i ġtb ev msMvĚb tĚĚvĚĚi mġ nĚZ cvĚi |

ḡ Ae GW#Kkb

- KZḂ;AcḂYi mgq weḡePbv KitZ nḡe th, e^{ir3} weḡkḡli ḡbKU bq eis cḡi ḡbKU KZḂ;AcḂ Kiv nḡQ|
- tKvb cḡi ḡbKU ḡK cwiḡvY `vḡqZ; I KZḂ;AcḂ Kiv nḡqḡQ Zv cwi⁻viḡvḡe Dḡj ḡLZ ḡvKv DḡPZ Ges msMVḡbi mKj ḡKB AewZ Kiv DḡPZ hvḡZ tKvb KZḡZ; ḡeaZv ḡbḡq mgm^{vi} mḡḡ bv nq|
- tKejḡvḡ KZḡZ; tmB Ask ḡbḡḡḡḡi AḡcḂ nḡqv DḡPZ hv Zvḡi thvM⁻Zvi DcḡhMx nḡe Ges dj cḡh⁻ḡ ḡbivcḡ⁻ PPPKiḡZ cviḡe|
- KZḂ;AcḂYi ci Zv KvhḡixKiḡYi e^vcvḡḡi Aa⁻ḡbi KvḡR n⁻ḡḡc Kiv DḡPZ bq| EaḡḂb KZḡḡḡi AhwḡPZ n⁻ḡḡḡḡci dḡj Aa⁻b KZḡḡḡ ḡm^xvḡḡ MḡḡḡYi Kj vḡKḡkj I thvM⁻Zv AvqZ; KiḡZ e⁻ḡḡḡḡ| Zḡe Aa⁻b KZḡḡḡ KZḡ. AḡcḂ KZḡZ; Ace⁻envi hvḡZ bv nq tm e^vcvḡḡi EaḡḂb KZḡḡḡ Aek⁻B j ḡḡ ivLḡeb|



cvtVĚi gj`iqb: 2

A) eú ubePbx cĕæ

mĭWK DĚi ůbt`Rgj-K AŕiĭuĕK eĚvĭqZ Kiab| (D`vniY: Avcbri ubePZ DĚiĭu K ntj GĕK (K) eĚvĭqZ Kiab)

1. KZĚj.AcP Aaxb`ĕ`i Rb`ĭK mĭeav etq Avtb?
 K. Zvt`i `bĭZK gĕbrej | AvZĕekĭm ep` Kĕi
 L. Zviv , iaZcP`elq , tj vtZ Mfxi gĕbthvM ĭ`tZ cvti
 M. Zvt`i Őviv KvĕRix tbZZj.Mto I tV
 N. Zviv cĕvb cĕvb , iaZcP`elq i `vĭqZcĕB ntZ cvti |

2. tKvĭu KZĚj.AcPĭi cĕ_ mĭsMVĭbK cĕZeĖKZv?
 K. RbMĕYi `pĕi mĭgĕb_ vKvi tbkv
 L. Aaxb`ĕ`i cĕĕ t_ĕK AvbMZ`nxbZvi fq
 M. mĭsMVĕbi ep`vKvi | Ae`vb
 N. mĕthvMĕ`i Dci Av`ri Afve|

3. KLb KZĕZji `eaZv ůbtq mĭm`vi mĭp nq?
 K. KZĚj.cĕqvtMi bĭvZi Dĕj ĕ bv_ vKĕj
 L. tKvb cĕ`i ůbKU ĭK cĭi gĭY KZĚj.AcP Kiv ntqĕQ Zvi Dĕj ĕ bv_ vKĕj
 M. KZĚj.cĕqvtMi Kvĕeĕvj xi Dĕj ĕ bv_ vKĕj
 N. KZĚj.AcP ĭj ůLZfĕte bv ntq_ vKĕj |

Av) mĭsĭĭB DĚi cĕæ

1. KZĚj.AcPĭi ĭkĕĭvMZ gj` ej tZ ĭK tevSvq?
2. KZĚj.AcPĭi mĭsMVĭbK cĕZeĖKZv , tj v ĭK?
3. KZĚj.AcPĭi e`ir³MZ cĕZeĖKZv , tj v ĭK?
4. KZĚj.AcPĭi KĕqKĭu mĭvri Y bĭvZi Dĕj ĕ Kiab|



mĭWK DĚi

A) 1| K, 2| M, 3|

- 3) `dji bZb uk`K ubtqm ubqgvbM Kivi Rb` Ges Salary Support c0v`bi Rb` ubtqm m`u`K` me`AB I Resolution-Gi Kucmn c0qvRbxq KVMRCI gnvcwi Pvj tKi KvQ tc0Y Kiv|
- 4) me aitbi gva`ugK uk`Kv c0Z0vb cwi`k0 Kiv|
- 5) Dc-cwi Pvj tKi ubt`R gZ thme gva`ugK me`ij q `xKuZ. I Avafie`i Avte`b Kti Zv cwi`k0 Kiv|
- 6) gva`ugK uk`Kv c0Z0v`bi Dbqbgj-K Kg`P ev`evqb I Z`E`eavb Kiv|

Dch` `vqZi,tjv cvj b Kivi mvt_ mvt_ Av`uj K Dc-cwi Pvj K KZR. Auc` temi Kvix `x ms`v`st th tKvb `vqZi| tRjv uk`Kv KgRZP cvj b Kti `v`Kb| tRjv uk`Kv KgRZP `x KZE`K `x cwi tek m`u`K`Dct`k-ubt`Rbv c0vb, `dji thvM`Zvm`ub`b`b`Zg msL`K uk`K I b`b`Zg uk`Kv`Kiy AvtQ uk`Kv tm m`u`K` tLUR-Lei tbi qv, cix`vi djvdj ch`j vPbv Kiv BZ`w `vqZi cvj b Kti `v`Kb| G cwi`tc0`K `x KZE`K `vbxq uk`Kv KZE`K mvt_ tm`snv`e`m`u`K`i`Kv Kti Pj tZ nq|

`vbxq uk`Kv KZE`K (c0`ugK `fi)

c0`ugK uk`Kv `fi mivt`tk 481 uU `v`v uk`Kv Aucm `vbxq uk`Kv KZE`K intmte KvR Kti `v`Kb| `v`v uk`Kv Aucmvi (TEO) Zui ubR `v`vi c0`ugK uk`Kv e`e`vcbv I Z`E`eav`bi `vqZi cvj b Kti `v`Kb| `v`vi A`M` mKj c0`ugK me`ij q`K KZK,tjv K`v`v`i mef` Kiv nq| mvariYZ GKU K`v`v`i 20 t`K 30 uU `x A`f` `v`K Ges GKRb mnKvix `v`v uk`Kv Aucmvi (ATEO) GKU K`v`v`i `vqZi; ubtqmRZ `v`Kb| uZvb c0`ugK uk`Kv `YMZ gv`v`q`bi j`K` K`v`v`i A`M` mKj c0`ugK uk`Kv`Kti c0`K`Y Kv`e`g cwi`k0 I Z`E`eavb Kti `v`Kb| `v`v uk`Kv Aucmvi`i Dci thme KZ`j.I `vqZi;Ac` Kiv ntqtQ Zv nj :

- 1) c0`ugK me`ij qmg`ni cwi`k0 I Z`E`eavb Kiv;
- 2) Avqb-e`qb KgRZP`intmte KvR Kiv;
- 3) uk`K I KgPvix`i e`jx, Aemi, tcbkb I Avb`ZvmlK msuk0 c0`e I KVMRCI tRjv c0`ugK uk`Kv Aucmvi (DPEO)-Gi ubKU tc0Y Kiv;
- 4) Thana Education Committee (TEC)-Gi m`m` miPe intmte KvR Kiv| TEC-Gi m`x`st tgvZiteK AM`aKvi w`f`E`Z Dbqbgj-K Kv`Ri Rb` c0`ugK me`ij qmg`ni Zvuj Kv c0`Z Kiv|
- 5) c0`ugK `x m`u`K` hveZxq Z`w` msM0 Kti tRjv c0`ugK uk`Kv `Bti ev Av`Bti tc0Y Kiv;
- 6) thme GjvKvq tKvb `x tbB tmme GjvKvq bZb `x `v`v`bi mg`wi k Kiv;
- 7) uk`KKe`i m`v`f`e` c0`Z Kiv I nvj bvMv` Kiv|

ḡ Ae GW#Kkb

ḡ KZ@ḡ I ḡKḡKe,`K ḡj i ḡB Rbms#hv#Mi weifbægva`g I ms`v, ḡKḡK-
AiwffveK mḡḡZ, e`e`vcbv KḡḡU I ḡbxq ḡKḡv KZ@ḡ m`ú#K`Rvb#Z nte| Zḡ i
`úó aviYv `vK#Z nte G mg`I ms`vi h_v`©fḡKv I Kvhe`x#Z m`ú#K`G mg`I
ms`vi mv# mym`úK`eRvq ti#L, G# i gva`tgB ḡ#K Zvi Aw`Zj;ḡḡK#q ivL#Z nte
Ges Db#Zi ḡ#K GḡM#q th#Z nte| Zḡ i#K D#`vMx n#q G e`vci#i AM`x fḡKv
cij b Ki#Z nte|



cvtVĒi gj`vqb: 3

A) eū ubePbx cĕæ

mĭWK DĒi ũbț`Rgj-K AŋiũtK eĔvĭqZ Kiab | (D`vniY: Avcbri ũbePZ DĒiũ K ntj GțK (K) eĔvĭqZ Kiab)

1. tKvĭũi gva`tg gva`ıgK ũe`ij q KZEŋ DaŶZb KZEțŋi mř_ thvMřthvM Kti?
 - K. RvZıq ms`v
 - L. AvĀıj K ũkŋv`Bi
 - M. tRj v ũkŋv`Bi
 - N. _vbn ũkŋv`Bi |
2. ũkŋvi gj- Kvhĕıg tKv_vq cwi Pııj Z nq?
 - K. ũe`ij țq
 - L. AvĀ`Bti
 - M. RvZıq ms`ımgțn
 - N. ũkŋv gŶıj țq |
3. tKvĭũ tRj v ũkŋv KgRZĤ Kır bq?
 - K. `țj i bZb ũkŋK ũbțqıMi ũeĀıB gıvcwi Pıj țKi KřQ tcĀY Kiv
 - L. `țj i `ıKıZ. cĀvb Kiv
 - M. gva`ıgK ũkŋv cĀZĀıbi cwi`kĬ Kiv
 - N. ũkŋKț`i teZıbi mıKıx Abıvb m`ııKZ KıMRcĬ cıxŋv Kti t`Lv |
4. cĀıgK `ti `vbxq ũkŋv KZEŋ țKvĭũ?
 - K. tRj v cĀıgK ũkŋv KgRZĤ
 - L. _vbn ũkŋv KgRZĤ
 - M. _vbn ũbePbx KgRZĤ
 - N. mnKıx _vbn ũkŋv KgRZĤ |

Av) msıŋB DĒi cĕæ

1. ũe`ij țqi mř_ `vbxq ũkŋv KZEțŋi m`ııKıKıfc Zv Dțj Ĭ Kiab |
2. tRj v ũkŋv KgRZĤ`i `ııqZı | Kvhĕj x Dțj Ĭ Kiab |
3. _vbn ũkŋv KgRZĤ `ııqZı | Kvhĕj x Dțj Ĭ Kiab |



mĭWK DĒi

A) 1 | M, 2 | K, 3 | L, 4 | L |

evsj v`tk ukvkv ckvmb I e`e`vcbvi mgm`v

fvkV

ukvkv e`e`v`tk msnZ I KvhRixKiYi Rb` mgzvukvkv ckvmb I e`e`vcbvi , iaZ;
 Acvixmg| e`Z myp ckvmbK vfvE`tk DEg ukvkv e`e`vi c`vb `eikó` intmte vPvYZ
 Kiv nq| eZgub v`tk; Dbz t`kmg`n ukvkv c`vi va I Kg`vivaq thgb e`ckZ; I AvfBeZ;
 GtmtQ tZgub Gme t`tk ukvkv ckvmbK vfvE` I e`e`vcbvi t`vtI I , YMZ Dbqb
 mvaZ ntqtQ| Ab`v`tk evsj v`tki gZ Dbqbkxj t`kmg`n Av`vkvRK Pvn`vi
 t`vtI ukvkv c`vi gvYZ v`vZ. NUtj I Gi , YMZ gv i`vvi Rb` c`qvRbxq ckvmbK
 I e`e`vcbviMZ ms`vi mvab Kiv m`e nqub| h`Mi c`vi gvq evsj v`tk ukvkv GKvU
 v`vZ. mvsMvK I ckvmbK Kvvtgv Mto D`vtQ, mgM`t`tk Gi Kvh`vtI c`vi e`B ntqtQ
 Ges e`u miKvvi -temiKvvi c`vZ`vb I KgRZ`KgPvix Gi mt`_ c`v`vfvte msvkó
 i`vtQb| vKŠ` bvbvea Av`vkvRK I vKQv HuznvvmK Kv`vY ckvmb I e`e`vcbvi v`vZ
 k³ I `vqx ntq Mto bv I Vvq mKj t`vtI B mgm`v DE`vEi evx t`vtQ RvUj Zi ntq
 ctotQ|

eZgub BDub`Ui `v cvtV evsj v`tki ukvkv ckvmb I e`e`vcbvi t`vtI v`vRZ KtqKvU
 , iaZ`v`mgm`vi Dci Avtj vKcvZ Kiv ntqtQ Ges mgm`v , t`v `vKiYi Dcvq m`v`tk®
 Avtj vPbv I mgvvi k c`vb Kiv ntqtQ|

- cvV- 1: ukvkv ckvmb I e`e`vcbvi mgm`vevj
- cvV- 2: ukvkv ckvmb I e`e`vcbvi mgm`v mgvavtbi Dcvq

teZb I gh®vi w`K w`tq ukŷv wefvMi ubtPi `limgfni c`_tjvi mvgwMk ckvmb e`e`vq tKvb ,iaZcY®vb tbB| dtj Kvhŷŷt Zuv Dchŷ vb civ bv etj Zt`i weikó fvgKv cvj tbi mŷhvM NtU bv| `fveZB ukŷv ckvmb e`e`vi Dci Gi cŷZKj cŷZdj b NtU|

O) mgštqi Afie

ukŷv e`e`vq weifbawefvM Ges GKB wefvMi weifbawefvMi gta` mnthvMZv I mgštqi Afie itqtQ| `ŷ I cwi`k® wefvM Ges Ktj R wefvMi gta` mnthvMZv I mgštqi wekI tKvb e`e`v tbB| tZgub `ŷ cwi`k® Ges GKB wefvMi weifbawefvMi gta` mnthvMZv I mgštqi Afie itqtQ| `ŷ I cwi`k® GB GKB wefvMi gta` cŷvK I gva`vK `fii gta` mnthvMZv I mgštqi Afie ckvmbK e`e`vi mŷz cwi Pvj bvi cwi cšx|

P) ckvmbK cŷŷŷYi Afie

ukŷv ckvmb e`e`vq Dchŷ cŷŷŷYcŷb thvM` ckvmbK I ckvmb cŷŷŷY e`e`vi Afie itqtQ| eZŷv b ukŷv wefvMi ckvmbK tŷŷt ubtqvMi Rb` tKvb cŷŷŷYi cŷŷvRb nq bv| ukŷŷKt`i ŷviv mvaviYZ ckvmbK tŷŷt c`_tjv ciY Kiv nq| GB ukŷŷKt`i ckvmbK weItq cŷŷŷYi tZgb tKvb e`e`v tbB| Ggb wK ukŷv ckvmb wefvMi ubtPi `fi mivmvi fite ubtqvM cŷb KgRZŷ`i I cŷŷŷYi tKvb e`e`v tbB| Gi dtj ukŷv ckvmb e`e`vi cŷŷ hZUv KvhRi cšv MŷY Kiv DvPZ ZZUv KvhRi cšv Aej`b Kiv m`e nŷq I tV bv|

Q) RvZxq ukŷvbnvZi Afie

`vaxbZv jvtfi `xN® b cŷi I tKvb RvZxq ukŷvbnvZ cŷxZ nqub| RvZxq ukŷvbnvZi AeZŷv b mgŷq mgŷq ckvmbK Avt`k etj ukŷvbnvZ ubaŷi Z nŷq AvmŷQ| GB cŷYzv Avgvŷ`i ukŷv ckvmb e`e`vi GKvU ,iaZcY®vU| RvZxq ukŷvbnvZ nŷq hveZxq ukŷv KgŷvPi Drmgj-| KvŷRB RvZxq ukŷvbnvZi Avtj vŷK hZv`b ukŷv Kvhŷg cwi Pwŷ Z bv nŷe ZZv`b ukŷv Kvhŷg avivevwnKZv I mŷvgaM` eRvq ivLv m`e nŷe bv| GUv AZ`šl Avbŷ`i K_v th, `xN® tbi cŷxvŷZ RvZxq ukŷvbnvZ 1998 mŷtj cŷxZ nŷqŷQ| RvZxq msm` KZR.Abŷgvv` Z nI qvi ci GvU kvNB KvhRix nŷe etj Avkv Kiv hvq|

ckvmb I e`e`vcbvi mivŷŷZK mgm`vej

Dcwi Dvŷ vLZ mvariY mgm`vej `xN® b aŷi Avgvŷ`i ukŷv ckvmb I e`e`vcbvi tŷŷt we`gvb itqtQ| mgvŷRi cwi evZŷ cwi w`vZi mŷ_ mvgAm`vxb cvjZb ckvmb e`e`v Pvj y _vKvi KvŷŷYB GLb chŷŷ Gme mvariY mgm`vi ubimb m`e nqub| mivŷŷZK Kvŷtj Avi I bZb wKQymgm`vi D`e nŷqŷQ hv cwi w`vZŷK AvvKZi RvUj Kŷi ZŷtŷQ| G`_tjvi ga` t`ŷK KŷqKvU ,iaZcY®mgm`vi K_v ubtP Dŷtj v Kiv nj |

K) ւեղը Բիմդն Rbetji Afie

ւեղը Աա՛Bi, AvĀuj K Aւժm I tRj v ւեղը Aւժtmi Rbej cժըvRժbi Zժbvq AZ՛ճ Kց| mււցZ msL՛K KցՔZՔ I KցՔvix ւժtq մջZvte ւեղը e՛e՛ււcbv I cւի Pյj bv mթե bq| ւեղըvq e՛ււcK ms՛ւի I mթւնիտի th KւR նտZ tbl qv նտտQ GB mււցZ Rbej ւտq Zv cւի Pյj bv Kiv mթե նտ՛Q bv| dtj AւաKւsk տղտի ԽՆՈՒԻ Zvi Rբ ւտ՛Q, RbMտիYi տիMւմճեւոտQ Ges e՛՛Zvi ՛ււց՛ււցZ;ւեղը Aւա՛Btii I ci eZթ՛Q|

GՕւov miKւի ւեղը cժZՕտb Օւի ւեղըK AbցտZ ZZxq I PZZ՛tkՈYi KցՔvixi cժըvRբxq msL՛K c՛ bv ՛ււKւq Aւա՛Bi, AvĀuj K Aւժm, tRj v ւեղը Aւժmnn miKւի ւեղը cժZՕտb յtj տZ APj ve՛ւի մյժ նտտQ| G Օւov I ZZxq I PZZ՛tkՈYi KցՔvixտ՛ i tgav I thvM՛Zvi ււււէZ c՛ււււZi tKւb e՛e՛ււ bv ՛ււKւq Zviv ՛ււՈ՛ւ b GKB c՛ KցՔZ AvտQ| dtj Zտ՛ i գտա՛ nZւkv I KւտRi cժZ Abւնvi գտբւեւ ւեւR KiտQ| մջzcււմb e՛e՛ււ ՛ււ՛Gi Aemvb nI qv evĀբxq|

L) miKւի I temiKւի ւեղը cժZՕտbi գտա՛ elg՛

miKւի I temiKւի ւեղը cււմb I e՛e՛ււcbvq ՛elg՛ ւեւR KiտQ| temiKւի ւե՛ւյq, Kտj R, gv՛ււմvi ւեղըKe,՛ miKւի KZR.Aբյvb տտq ՛ււKտj I miKւի ւեղը cժZՕտbi gZ տcbkb, MՕՔՅՈ BZ՛ււ մտիւM մյթav cvb bv| ZvՕւov ւեւրբեւ temiKւի ւեղը cժZՕտbi գտա՛ Օւի տեZտbi e՛ււcK ZviZg՛ itտQ| մջzcււմմbK e՛e՛ււcbvi ՛ււ՛G Ae՛ււ ւbi mb nI qv cժըvRb|

M) ւեղը cժZՕտb miKւի KiտYi ւեZւKՉ bււZցյ v

ւեղը cժZՕտb miKւի KiտYi tKւb մջzւււZցյ v bv ՛ււKւq RvZxqKiYKZ.ւեղը cժZՕտbi ւեղըKտ՛ i մտ՛/2 միւմի cժZthvMZvgj-K ւեւmGm cixղvi գտա՛tg ւժtqւMKZ.ւեղըKտ՛ i տR՛ՕZv, տMՈՒKb Zւյj Kւq ււq Aճիթ, c՛ււււZ BZ՛ււ ւեւտq ւիւv aiտbi Rււj Zv մյժ նտ՛Q Ges AտbK տղտի AvBbMZ Rււj Zv I gvյj v tgvKւի gv մյժ նտ՛Q| մջzcււմb e՛e՛ււ ՛ււ՛G Ae՛e՛ււ ւbi mb nI qv evĀբxq|

N) temiKւի ւեղը cժZՕտbմդնի cււմմbK Rււj Zv

temiKւի ւեղը cժZՕտb ւեղըK, KցՔZՔ I KցՔvix ւժtqտMi տղտի տZgb tKւb KZԷղ տb| GKււ PւKւ ւեւա I bւււZցյvi AvտjտK ՛՛ cժZՕտb Kւցււի գտա՛tg Zտ՛ i Bտ՛ՕցւժK cժըvRբxq ւեղըK KցՔvix ւժtqւM Kտi| ւժtqտMi տղտի e՛ււcK Aւոցq I ւեկ;Lj v j ղ Kiv հւq Ges G ւժtq cժժ gvյj v tgvKւի gv նտq ՛ւտK hv cւււմմbK Rււj Zvi մյժ Kտi| GՕւov ւեղըKտ՛ i c՛ււււZi tKւb e՛e՛ււ տb| Dchթ tgav I thvM՛Zvմթեւե ւեղըK ւժtqտM Rււj Zvi մյժ nq|

0) ct`vbnzi tŋtĭ `wŋwZv I AmgZv

eZŋv#b Ktj R ukŋKt`i ct`vbnzi tŋtĭ mgZv iŋv Kiv mæe nt`Q br| KviY eZŋv#b
welqirfwiEK ct`vbnz cŏvb Kiv nq| dtj cŏZthwMzigj-K weimGm cixŋvi gva`tg GKB
m½ PKwi#Z thvM`vb Kti tKvb tKvb welŋqi ukŋKMY D³ welŋq c` kb`_vKvi Kvi#Y
ZrovZwo ct`vbnz tctq hv#Qb| cŋvš#i ukQymKQymelŋqi ukŋKMY ct`vbnz cvl qvi
Rb` meiv`#K thvM` nI qv m#EjI welŋq c` kb` br_vKvq mivWK mgŋq ct`vbnz cvt`Qb br|
dtj wZvb Rŋŋqi ntq_vKtQb| GtZ mgzckvmb I e`e`vcbvi tŋtĭ GK RŋUj Ae`vi
mŋŋ nt`Q|

P) Acvi Kiv Zfvte ukŋv cŏZŏvb `vcb

tKvb cKvi `g` g`mcs Kvhŋg br_vKvq t`tki weifbæ`v#b bvbwea Kvi#Y cŏqvR#b I
AcŏqvR#b ukŋv cŏZŏvb Mto DVtQ hv ukŋv e`e`vcbvi tŋtĭ `bivR` mŋŋ Ki#Q Ges
ukŋvi I ci A#nZK Pvc evotQ| hTzT we`ij q Mto I Vvq ukŋvi ,YMZ gvb µgviŋq
wb#Pi w`#K tbtg hv#Q| ukŋv cKvmb I e`e`vcbvi tŋtĭ GuU GKŋU ,iaZcYµŋU|

Q) vbqšŷ emfZ ukŋv cŏZŏvb

evsj vt`tki ukŋv e`e`vcbv bivfvte nef³| miKvvi, temiKvvi, `ŋqĖkvmmZ I
Avav`ŋqĖkvmmZ miKvvi vbqšŷvaxb ukŋv cŏZŏv#bi evB#i I e`w³ I tMvŏx gvŋj Kvbvaxb
weifbæ`#i i weifbæat#bi ukŋv cŏZŏvb itq#Q| thgb- ukŐvi Mv#UŦ, BstivR gva`g I-
tj#fj Ges G-tj#fj ukŋv cŏZŏvb, wŐK`v#WU, tKv#Ps tm#Uvi BZ`w` hv`i I ci
miKv#i i tZgb tKvb KZŒj.tbB| ukŋvi cKvmm#K tŋtĭ bvbwea RŋUj Zv mŋŋi cikvcv#k
Gme cŏZŏvb GKŋU mgZwfvwiEK RvZxq ukŋv e`e`v Mto tZvj vi ct`_ cŏZeÜKZvi mŋŋ
Ki#Q|



cv#VvEi gj`vqb: 1

A) msu#B DEi c#æ

1. uk#v c#vmbi t#t# #gZv, `vqZ; I KZ#; i vRavb#Z tK#`KiY Kiv ntqtQ-
K_v#U e`vL`v Kiab|
2. uk#vbmZi t#t# uk#vme`#`i g#Zi c#avb` t`qv D#PZ tKb?
3. c#vmb i #Ykxj g#bvfve t`Lv t`q tKb?
4. Avcbvi g#Z uk#v c#vmb I e`e`vcbvi t#t# m#u#ZK Kv#j i #Zb#U c#avb
mgm`v D#j L Kiab|

Av) iPbvgj-K c#æ

1. evsj v#`#ki uk#v c#vmb I e`e`vcbvi m#vriY mgm`v, #j v uK?
2. uk#v c#vmb I e`e`vcbvi t#t# m#u#Z D#m#Z mgm`v, #j v e`vL`v Kiab|

cW 2

ukŋlv cġvmb I e`e`vcbvi mgm`v mgvaŋtbi Dcvq

Dŋ`k`

GB cvW tkŋl Avcb—

- ukŋlv cġvmbK ŋgZv, `vqZj I KZZŋ.veŋKw`KiŋYi KŋqKwU Avv c`ŋŋc Dŋj L KiŋZ cviŋeb;
- ukŋlv cġZōvb I `Bimgŋni Rbej evxi cġqvRbxqZv e`vL`v KiŋZ cviŋeb;
- miKvvi I temiKvvi ukŋlv cġZōvŋbi gŋa`elg` hKiŋYi KŋqKwU Dcvq eYŋv KiŋZ cviŋeb;
- ōGWŋKkb tkwŋŌ-Gi cġqvRbxqZv e`vL`v KiŋZ cviŋeb Ges
- ukŋlv cġvmb I e`e`vcbvi Dbqŋtbi Rb` cġqvRbxq c`ŋŋc,tjv eYŋv KiŋZ cviŋeb|

fŋgKv

Avvŋt`i t`ŋki ukŋlv cġvmb eZŋvŋt bvbvnea RvUj, e`vcK I ,iazi mgm`vi mŋŋab| G tcŋŋŋZ KŋqKwU ,iaZcŋmgm`vi Dci AvŋMi cvŋV AvŋjvPbv Kiv nŋqŋQ| G K_v Ab`ŋKvth ukŋlv e`e`vi Gme mgm`v I `ŋŋZv vRBŋq tiŋL tkvb Ae`ŋŋZB Avvŋt`i ukŋlv CwŋZ j ŋŋ` ARŋ mŋe nŋZ cvŋi bv| ZvB evsj v`ŋki ukŋlv cġvmb I e`e`vcbvi ms`vi I cŋveŋ`im GKvŋŋŋŋ cġqvRb| G cŋŋŋ KzivZ-G-Lŋv Kvgkb wŋŋcŋU[©] (1974), gwŋR Dvŋb Kvgkb wŋŋcŋU[©](1988) I RvZxq ukŋlvbŋwZ KvgvU wŋŋcŋU[©](1998) thme mgvŋik cŋvb KŋŋŋQ Zvi AvŋjvŋK Ges eZŋvŋt cvŋŋek I cvŋv`wZi tcŋŋŋZ wŋŋŋe³ cŋve,tjv veŋePbv Kiv thŋZ cvŋi |

ukŋlv cġvmb I e`e`vcbvi mgm`v mgvaŋtbi Dcvq

1. ukŋlv cġvmb ŋgZv, `vqZj I KZZŋK veŋvŋŋq, tRjv I `vbv chŋq chŋŋveŋKw`KiY KiŋZ nŋe

gva`ŋgK I D`P ukŋlv Avv`Bŋi Aaxŋt eZŋvŋt t`ŋk bqŋU Dc-veŋvŋŋq ev Avŋŋj K `Bi iŋŋŋQ| GB Avŋŋj K `Bi ,tjvŋK Avcŋŋŋ KiŋZ nŋe Ges cġqvRbxq msL`K KgŋZŋ, Kgŋvix wŋqŋM KiŋZ nŋe| Avŋŋj K `Bimgŋni Zŋŋeavŋt `^`^Aŋŋj gva`ŋgK ukŋlv, D`P gva`ŋgK I Kŋj R ukŋlv Ges gv`vŋv ukŋlv `vqZj_vKŋe| Avŋŋj K `Bi bZb ve`ij q cġZōvj ŋŋcġqvRbxq `ŋKwZ. `vb, `ŋKwZ. bevqb, `ŋKwZ. evwZj, g`vŋŋRs KvgvU Abŋŋv`b cŋvb, ukŋlv cġZōvŋbi ukŋlv KgŋZŋ I Kgŋvix`i GvgvU fŋŋKiY Ges teZb fvZvi miKvvi Aŋŋi A_ŋŋ eĚb, wŋR wŋR GjvKvi gŋa` miKvvi `ŋŋ I Kŋj Rmgŋni ukŋlv KgŋZŋ I Kgŋvix`i e`jvKiY, tcbkb, MŋPŋw, bv_ cġqvKiY BZ`w` cġvmbK `vqZj cvj b Kiŋe| t`ŋki ŋgeaŋv ukŋlv ŋŋ ,YmZ gvŋmŋŋbŋŋŋŋ wŋŋŋŋZKŋŋi Rb` veŋKw`ŋZ cġvmb e`e`vi veKŋ tbB| tRjv ukŋlv Avŋŋv c`wU

tRjvi Ab`vb` KgRZP mt½ mvgAm` wearb Kti Dc-cwiPvj K chiq DbrZ KitZ nte|
ukv v cZovtbi ZEyearb I cwiexvY tRvi`vi Kivi jtv` we`vjqi msL`vbyvfi
we`vj q cwi`kR/cwi`ukRvi c` mwp KitZ nte, thb cZvU we`vj q vzb gvtm ASZ
GKevi cwi`kR Kiv mae nq| we`vj q cwi`kRMY GKvWvgK ZEyearvbi mt½ mt½
AvvR I ckvmbK ZEyearvbi`vqZi| cvj b Kitb| tRjvi we`vj q cwi`kRMY Zv`i
cwi`kR cZte`b I cwi`kRkZ. we`vj qmgfni muU wePvZ chqvPbvi Rb` cZ gvtm
GKevi AvAvj K cwiPvjtki mt½ vgvj Z nteb Ges we`vjqi muU`hKitYi Rb`
KihRi e`v MhY Kitb|

eZvfb gva`vgK chiqi cZovbmgf (mviaviY gva`vgK ᚦ, gv`vuv I evEgj-K
gva`vgK cZovb) ZEyearb I t`Lvtkvbi Rb`_vbi chiq tKvb cKvi e`v tbB|
gva`vgK chiq ukv v cZovb t`Lvtkvbi Rb`_vbi chiq GKvU mnKvix cwiPvj K I
GKvU we`vj q cwi`kRki c` mwp KitZ nte| Gfite ukv v ZEyearb I ckvmbK e`v
eZvfb i vRavb t`tk weKv`Ki Y Kti _vbi chiq chSvbtq thZ nte|

2. ukv v`Bimgfni cynevm I Rbej evx KitZ nte

ukv v Avv`Bi, AvAvj K Avdm I tRjv ukv v Avdtmi KgRZP I KgPvixi msL`v AZ`šl
muvGZ| GB muvgZ Rbej vbtq mvi v evsjv`tk mKj miKvvi I temiKvvi ukv v cZovb
cwiPvj bv Ges ukv v ev`evqb mgvzite m`ubekiv mae bq| mvi v`tk j v j v ukv v K I
KgRZPKgPvix KgPZ itqtQb| Z`vvi t`tki ukv v mt½ m`u³ temiKvvi ukv v
cZovtbi AeKvvtgv I teZb fvZv LvZv wecy At`i A_`e`q Kiv nq| Gi cvj
KvhvrgB gv`Z Avv`Bti i gva`tg cwiPvj Z n`Q| gnvvviPvj K`qs Avqbe`qb KgRZP
vntmte temiKvvi ukv v KgRZPKgPvix`i teZb fvZv cZvbi`vqZi cvj b Ktib| G
wecy cwi gvY A_`e`vcbv, evtRU c`vq I vnmve msvvYi Rb` tKvb Rbej tbB|
dtj ckvmbtK bvbvea mgm`vi m`vab nZ n`Q| GbvG KvgvU mgvvi k tgvziteK ᚦ
I Ktj tR ZZxq I PZz`tkvYi KgPvixi msL`v h`o cwi gvY nvm Kiv nqtQ| dtj
mvi v`tk miKvvi ᚦ, Ktj R, gv`vuv, Kvvi Mvi ukv v cZovb, tRjv ukv v Avdm,
AvAvj K Avdm I ukv v Avv`Bti ZZxq I PZz`tkvYi KgPvixi Afite mgvzite KvR
m`ubekiv hv`Q bv| AvvKs`miKvvi ᚦj vZxq ukdW cZv Kti QvT QvTx msL`v I
ukv v Kti i msL`v v`Y Kiv nqtQ| miKvvi Ktj R, tjtZ hT ZT m`yb I gv`vm`tkv
cZv Kti QvT-QvTx msL`v e`v Y evx Kiv nqtQ, tmB mt½ ukv v Kti msL`v evx
tctqtQ| vgeavb QvT-ukv v Kti Pvn`v tgvziteK ZZxq I PZz`tkvYi KgPvixi tKvb
bZb c` mwp Kiv nqib eis GbvG KvgvU v`vU`ev`evqb Kti ct`i msL`v Kvgv t`I qv
nqtQ| dtj ᚦ Ktj tR APj Ae`vi mwp nqtQ|

G Ae`v vbi vbi Rb` QvT/QvTx I ukv v Kti msL`vbgvZ miKvvi ᚦ, Ktj R, vUv
Ktj R, gv`vuv I Kvvi Mvi ukv v cZovbmn tRjv ukv v Avdm, AvAvj K Avdm I
Avv`Bti c`qvRbvq Rbej evx i Rb` vZxq/ZZxq/PZz`tkvYi c` mwp KitZ nte|

3. KvRi clyivej I Kvj t`qcy tiva KitZ nte

t`tki eZgvb uk`qv e`vcbv I ckvmtbi wevfbae Bti i gta` tZgb tKvb mgstqi e`v
tbB| uk`qv gsjyjq I uk`qv cwi`Bi GKB KvRi clyivejEmn GKwaK ms`vq GKB
KvRi clyivejEi `0Z I uogjx e`vcbvi dtj Kvj t`qcmn ckvmtb `weiZvi mjo
ntqtQ| dtj `vqexZv uk`v_j nt`Q Ges Reven`wZv tjvc cvt`Q|

4. cwi`k0 e`vi AvapKvKiY KitZ nte

cwi`k0 e`vi eZgvb KvVtgv GKvU mguSZ KgmuPi AvI Zvq Gtb GK avivi ckvmtbK
I GKvWngK cwi`k0 KvVtgv MVb Kti AvAjij K, tRjv I _vbi chSf m`u`vni Z Kiv
`iKvi| G KvR mnvqZv `v`bi j`q` Avab`Bti eZgvb EMIS Kv`uDUvi tmj`K
m`u`vniY Kti AvapKvKiY Kiv c0qvRb| c0Z0vmbK Z_`w` msi`q`Yi e`v ubw0Z
Kti ubix`qv I cix`qY KvR mnRZi Kiv thtZ cvti| GQvor `z, Ktj R I gv`&vni
uk`qv Kvhpig I cwiex`qY KvR mnvqZv `v`bi Rb` Kv`uDUvii e`envi ubw0Z Kiv
c0qvRb|

5. ckvmb I e`vcbvq uk`vme`ti m`u`3 KitZ nte

`z I Ktj R chiqi uk`vni m`2 RwoZ uk`vme`ti e`vcbvq Avak nvti m`u`3
KitZ nte| tgav, `qZv I AvfAZvi wfiE`Z c0k`q`Yi gva`tg ubefPZ e`v`3`ti uk`v
ckvmtb ubh3 Kiv thtZ cvti| uk`qv K`Wv`ti thvM`Zv I AvfAZv Abjvqx me`ti
c`vbq`bi Rb` wetePZ nI qvi m`hvm`vKtZ nte|

6. uk`qv ckvmt`i c0k`qY c0v`bi e`v M0Y KitZ nte

uk`qv wefv`Mi Avdmv`ti`i ckvmtbK c` ubtqvRZ Kivi c`e`c0k`qY c0vb KitZ nte|
e`Zc`q` uk`vni mKj `ti uk`qv KgRZ`i ckvmtbK c` ubtqv`Mi Ae`wnZ cti Ges
c`vb`Zi c`e`uk`qv ckvmb I e`vcbv wltqi c0qvRbxq c0k`qY c0v`bi ubgg Kiv
m0z`uk`qv ckvmb e`v Mto tZvjvi Ab`Zg ceRZ` `zji c0vb uk`qK, Aa`q,
cwi`kR, wtkIA Ges KgRZ`i ckvmtbK I tckvMZ `qZvi DrKI`eavbKti wevfbae
tgqv`x c0k`qY tKvm`AvtqvR`bi Dci `iaZj` I qv c0qvRb|

7. miKvvi I temiKvvi uk`qv c0Z0v`bi gta` `elg` vbimb KitZ nte

t`tki uk`qv e`vq miKvvi I temiKvvi GB `v aviv itqtQ| miKvvi uk`qv c0Z0v`bi
gZ temiKvvi uk`qv c0Z0v`bi uk`qK ubtqv`Mi Rb` GKvU ubtqvM wewa I m0z`vniZgvjv
_vKv evAbxq| G Qvor `z g`v`b`Rs KvgvU Ges Mfub`ewW MVb I Zv`i` qgZvi h_vh_
e`envi ubw0Z Kivi Rb` mjoSZ bniZgvjv _vKv evAbxq| miKvvi I `vqE`kvmmZ uk`qv
c0Z0v`bi m`2 temiKvvi uk`qv c0Z0v`bi uk`qK I KgPvixi teZb `elg` GLbl
weivRgvb| ZvQvor G mKj c0Z0v`bi gta` QvT teZ`bi I e`vck ZviZg` itqtQ| G
mKj `elg` `i` Kiv c0qvRb Ges miKvvi I temiKvvi c0Z0v`bi QvT-QvT`x`i Avfbae

Ᾱ Ae GW#Kkb

teZb c0v#bi e'e-v vKv c0qvRb| temiKwi uk9lv c0Z0v#bi AeKvVtgvMZ Dbqb I ms-v#ii `vq `vqZj miKvi M0Y Kti QvI teZbv mn Ab'vb" Av`vqKZ. A_©miKwi tKvlMv#i Rgv t`lqvi e'e-v Kitj miKv#ii e'tqi thgb mvk# NUte tZgvb uk9vtKi teZ#bi 100% miKwi fvte c0vb Kiv m#e nte| GtZ uk9lv c0Z0v#bi `vq `vqZj e#x c#te Ges fqv uk9lv c0Z0v#bi vej#b NUte| Zte uk9K I KgPvixt`i Reven`mZvi e'e-v v#v0Z KitZ nte|

8. uk9lv c0Z0vb miKwiKit#Yi t9tI m#v# 0 b#vZgvj v Av#YiY KitZ nte

temiKwi uk9lv c0Z0vb miKwiKit#Yi Rb" m#v# 0 b#vZgvj v vKv evAbxq| GB b#vZgvj vq RvZxqKiYKZ. uk9lv c0Z0v#bi uk9K, KgRZP I KgPvixt`i PvKzms#všl vevavavb vKtZ nte hvZ cvevj K m#v# Kvgkb KZR. vbtqvMc0Bt`i mv#_ `t`_P msNvZ m#v# b#v nq| m#e ntj `v# `ZSjtM0Wkb Zv#j Kv `Zvi Kiv thtZ cvti|

9. e'v# gv#j Kv#v#b uk9lv c0Z0v#bi Reven`mZv v#v0Z KitZ nte

e'v# gv#j Kv#v#b uk9lv c0Z0v#bi GKvU m#eLj e'e-vcvq Avbv `iKvi | c0qvRtb G mKj c0Z0v#bi t9tI Reven`mZv v#v0Z KitZ nte| mgZvi v#v0Z GKvU m#v# 0 b#vZgvj vi gva'tg G mKj c0Z0vb c#i Pvj b#i e'e-v Kiv DvPZ|

10. Ᾱ g'vcs Ges uk9K t#vRt÷kb e'e-v PvjYKitZ nte

hIzI uk9lv c0Z0vb Mto tZvj vi c0YZv#K v#qS# Kiv c0qvRb| GjvKv v#v0Z Ᾱ g'vcs Kti c0qvRtb#i v#v0Z uk9lv c0Z0vb `vc#bi Av#gv`b t`lqv thtZ cvti| t`tk eZ0v#b uk9Kt`i t#vRt÷k#bi tKvb e'e-v tbB| c#_exi c0q Av#Kvsk Dbz I Dbqbkvj t`tk uk9K t#vRt÷kb c#vZ PvjYAv#Q| Avqv#i t`tkI G e'e-v PvjYKiv thtZ cvti| fv#l`tZ uk9K ntZ B"Q# Dch# tgav I thvM'Zvm#v#v#v# m#v#Y uk9lv I c0qvRbxq c0k9Y tk#l mb` jvf Kit#b| c0B m#v#i K#cmn Zv#i bvg t#vRt÷k#bi Rb" eQtii v#v0Z mg#q Av#v#j K c#i Pvj#Ki eiveti Avte`b Kit#b| Av#v#j K c#i Pvj K v#R v#R A#t#i Dch# tgav I thvM'Zvm#v#v#v# v#v0Z bvg t#vRt÷kb Kit#b| Gifc t#vR÷vW#v#v#v#v# eM#miKwi ev temiKwi Ᾱ, Ktj R I gv`v#v#v# uk9vtKi Rb" Avte`b KitZ cvte# Ges thvM' etj v#v0Z ntj v#v0Z cvte#|

11. uk9K v#v0ZMi Rb" GKvU c#K uk9lv KgKvgkb c0Z0v#bi KitZ nte

t`tki uk9lv e'e-vq miKwi Ges temiKwi c0_ugK I gva'ugK v#v0Z q, gv`v#v#v# I Ktj#R uk9K v#v0ZMi t9tI th Avbqg I Amgb#vZ Pj#Q Zvi v#v0ZKt# uk9lv#i c0_ugK `li t`tk D"P gva'ugK `li chS#(gv`v#v#v#v#v#) uk9K v#v0ZMi Rb" GKvU c#K uk9lv KgKvgkb MVb Kiv Av#K'K|

