

ကဏ္ဍစုံ စာအုပ်များကို အသုံးပြုခြင်း

EDM 1304

ကျွန်ုပ်တို့၏

အဖွဲ့အစည်း



ကျွန်ုပ်တို့၏ အဖွဲ့အစည်း



This book is licensed under a
Creative Commons Attribution 4.0 International License.

Educational Communication and Technology

EDM 1304

GgGll tcÖMög

cKvkKvj

cÜg gÿY: Wltmæ† 1999

clÿ: gÿY: 2001, 2004

clÿ:gÿY: Ribgmi, 2012

clÿ:gÿY: GllcÖ, 2014

cÖÖ`

KvRx mivBdžxb AveŸvm

KivúDUvi KtúúR Ges WlvUic

tgiv: RvKiv tnvfmb

© eisj vř`k DvgŸ vekte`vj q

ISBN 984-34-0046-1

cKvkbiq

cKvkbiq, gÿY I veZiY vefvM

eisj vř`k DvgŸ vekte`vj

MvRxcj- 1705|

gÿY

eisj v evRvi tclñ GÜ cievij †Kkb

53 b_ÖK nj tivW, eisj v evRvi

XvKv- 1100|

tKum@B AbryiY Kivi KuhRi ciugk©

ucq ikjvLx©

Dyg ikLb c×wZ wbfP GgGW ikjv tçMtg fuzhI qvi Rb" **ġ Ae GwKkb** AvcbiK Avšhi K Awfb`b Rvbt`Q| ikŋv thvMthvM I chvP (EDM 1304) tKum@BwU GgGW tçMtgI GKwU Avek`K tKumP GB tKvmp Df`k` nj ikŋv kvf`je`eüZ chvP i AvapK AMwZ m=utK@ari Yv j vtf AvcbiK mnvqZv Kiv|

G tKum@BwU cv" velqe`fK Avgiv mizwU BDwbU fivM KtiwQ| Gi gta` itqtQ thvMthvMi gva`g wntmte fvlv, tkŋYKtŋi fvlv, cvvmvgMö cŋqb, wgvwqvi fvgKv, thvMthvM chvP Ges ikŋY-wkLtb Z` I thvMthvM chvP i e`envi m=umkZ avi Yv, `enkó, cKvi f` , DcKiY BZ`w` m=Üxq AvtjvPbv|

EDM 1304 tKum@B cw I Abkxj tbi tytI Avcbi` i KiYq ik?

- "ikLb c×wZi gj- K_vB nj wbtR wbtR cto tkLv Ges wbtRi tPovq tkLv| Ab" K_vq, G c×wZi gva`tg ikjv_r@bR `wqtZj wbtRi mjev gZv mgq tkLvi KvR wbtqwrZ nb| e`Z G Df`k`fK mgq b ti fLB **ġ Ae GwKkb**-Gi wvfbwKvmp eB_vjv i wPZ| GtZ fveMZ HK" i yv Kti cvtVi velqe`fK KZ_vjv BDwbU fivM Kiv ntqtQ| Avevi BDwbU_vjvK KZ_vjv cvtV fivM Kiv ntqtQ| cöZwU cv cö_wgKfite GKevi cotZ Avcbvi 40-45 wgvbU mgq j vMte etj ati tblqv ntqtQ| cöZwU BDwbUi tkfI Avcbi wbtRB wbtRi cv AMwZ gj`vqb Ki fZ cvi teb| G Rb" cvtVi tkfI cvtVvEi ckgvjv i itqtQ|
- tKum@B covi mgq ik ik KvRi I ci_vjazjw`fZ nte?
 - cvtVvEi gj`vqtb ckgvjv DEi wbtR wbtR Kiab| Avcbvi DEi_vjv mWK nj ik bv, Zv cvtVi velqe`chvYy Kti wbtRB wvavPY Kiab|
 - cvtVvEi gj`vqtb me_vjv cöké DEi mWK ntj cieZxwBDwbU GwMtg hvb|
 - Avcbvi DEi_vjv mWK bv ntjv cv_vjv cbv vq cob| cov tkI ntj cvtVvEi gj`vqb ckgvjv DEi Kiab| DEi mWK ntj ci ci cvtV GwMtg hvb|
 - tKiv cvtV me_vjv cöké DEi mWK bv ntj tm cvtVi wv`@ Ask Avevi cob| Gfite cöZwU BDwbUi cv_vjv tkI Kiab|

eBwZ th mg`wbt`Rbugj-K wPy e`eyZ ntqtQ tm_vjv nj :

 D×wZ

 cvtVvEi gj`vqb

- cvV-mnvqK KgPv
 - GB eBwU Qvovl **ġ Ae GwKkb**-Gi mweR ZÉyavtb AvtqwrZ `vbxq GgGW wUDwUw qjv tmUvfi Avcbvi Rb" cöZ givm (2q-4_@_ev 1g-3q i µevi) `BwU wUDwUw qjv tmk`bi e`v`v MhY Kti fQ| Gme tmk`b thvM w`tq Avcbi eBwU tKiv Ask ev cvV cotZ wMtg tKiv mgm`vq cotj tm velq cöqvRbxq ciugk© wbt`Rbv MhY Ki fZ cvtV|

mPcĪ

	cW	cŦv
BDıbu 1	fvlv Kx I tKb?	1
	1.1 fvlvi ˘tjc	2
	1.2 thvMvthv†Mi gva˘g wntmte fvlv	5
	1.3 fvlvi KvR	7
	1.4 thvMvthv†Mi gva˘g wntmte fvlv: tkvıv I ejv	10
	1.5 thvMvthv†Mi gva˘g wntmte fvlv: cov I tj Lv	14
BDıbu 2	fvlweÁvb	19
	2.1 fvlweÁvb	20
	2.2 aŸvbZĒj	23
	2.3 ijcgj ZĒj	27
	2.4 evK˘ZĒj	31
BDıbu 3	fvlv ˘evPĪ˘	35
	3.1 gıv fvlv I AvÁıj K fvlv	36
	3.2 fvlvi tgšwLK I wj wLZ ijc	40
	3.3 fvlv I wkŸıv	44
BDıbu 4	tKıwK†Ÿı fvlv	49
	4.1 tKıwK†Ÿı cW˘v†bi fvlv	50
	4.2 Dc˘vc†b ˘ŸıZv I evPb tKškj	53
	4.3 fvlv wkŸıY c×wZ	56
BDıbu 5	cWmıgMŸ cŸqb	61
	5.1 cW˘c˘K cŸqb I gj ˘ıqb	62
	5.2 M˘˘ıPbv	69
	5.3 wclPri cŸqb	75
	5.4 m˘úıv˘bv	81

fvlv Kx I tkb?**fıgKv**

fvlv Kx I tkb? G cöké DĒi hZUv Avgvṽ`i tevṽai AŠMḶ ZZUv cKvkma" bq| K_vUv AvI mnR Kti ej tZ tMtj Ggb `wvte th, fvlv Kx Zv hZUv mnṽR eḶtZ cvwi ZZUv mnṽR eḶtq ej tZ cvwi bv|

gvbṽI tköṽZji K_v Avgiv hLb evj ZLb meri AvṽM Avgvṽ`i fvlvṽK ṽvb Kti wṽtZ nq| fvlvi I ci fi KtiB `wvṽq AvṽQ Avgvṽ`i gvbeṽq mĒv| gvby th mf`Zv bvṽgi weivU Bgvi ZıU wbgṽY KtiṽQ Zvi cāvṽb I meṽPṽtq gReṽZ LıU nṽ"Q fvlv| Avṽtj tjL" fvlv Qvov mf`Zvi DrKIṽI DĒiY- tkvbıUB mṽe wQj bv| mf`Zvi AMṽvṽṽK Avgiv AṽbK mgq Zvi bvbv iKṽgi nıwZqvṽi e`envi wṽtq wPıvY Z Kwi | BıwZnvṽteĒvṽ`i gṽa" G cĒYZv cKvU| wKŠ' wKQvıw wbeo Abṽvıb GK_v ṽúo Kti t`te th, meṽPṽtq kwṽkvj x nıwZqvıw nj Zvi fvlv| G nıwZqvıw e`envi KtiB tm RıwKvi Dcvq, ṽjv LṽR wṽtqṽQ, MṽtoṽQ cvıevi-Rıeb Ges Zvi weıPıwṽZ Rıebe`e`v| Avgvṽ`i mgvRRıeṽbi cvııa hZUv evotṽQ ZZB Avgiv Ḷṽṽ`t`_ṽK ḶṽṽZi wek' gvbeṽMıvöx Mṽto ZṽıwQ| G mṽKıvPbkıj weṽk' fvlvB meṽPṽtq kwṽai mṽ wṽṽmṽte KıR KiṽQ| G mṽ cvı ṽıwı K thvMṽthvṽMi Ges fvlvB nṽ"Q G thvMṽthvṽMi gva"g| Avgvṽ`i hZ wKQymıvökvj Zv, hZ wKQyDṽṽebv fvlvB ZıṽK aṽi tıṽLṽQ Ges weıPıwṽZ mṽṽebvq ZıṽK wefıwṽZ KiṽQ|

Avṽj vPbvı mṽṽavı Rb" GB BDıbuUıṽK cvıPıU cvıV FıM KtiıwQ| GB cvı, ṽjv nṽ"Q:

cvı- 1.1: fvlvi ṽṽc

cvı- 1.2: thvMṽthvṽMi gva"g wṽṽmṽte fvlv

cvı- 1.3: fvlvi KıR

cvı- 1.4: thvMṽthvṽM gva"g wṽṽmṽte fvlv: tkvbv I ejv

cvı- 1.5: thvMṽthvṽM gva"g wṽṽmṽte fvlv: cov I tj Lv

msthM I ḡnfwz

cieZvRvtj msthM (Contact) ZĒj I ḡnfwz (Gesture) ZĒj D^me NtUḡQ| G ḡ ZĒĒ fvlvtK cvi ḡwi K thvMḡthvḡMi gvaḡ wntmte ḡLv ntqḡQ| mgvReÜb gvbḡj i gḡa^h th Nubō thvMmḡ ḡbgḡy KḡiḡQ Zvi cāvb Dcvḡvb wntmte fvlvi DrciĒĒK ḡPvi Kievi cḡPōv GLvtbB| gvbḡj i KĒ ḡḡK tewiḡq Avmv aḡvb ḡjv hZvḡb A^ḡK aviY Kḡiḡb ZZvḡb bvbv iKḡgi Bkviv-BsivMZ mvgvRK gvbḡj i B^ḡQv-Avb^ḡQv I Avb^ḡ-te^ḡ bvtK GḡK Aḡb^ḡi KvḡQ tctḡQ ḡḡḡḡQ| AvRḡKi ḡḡb Avgiv hvḡK ḡḡni fvlv (Body Language) evj fḡzZĒj AḡbKUV ZvB| Avgiv tKej K_v evj bv, K_{vi} mḡz Rḡḡ ḡB ḡḡni bvbv iKḡgi fḡz| KvḡKI WvKḡZ nḡj nvZUV KLb K_{vi} mḡx nḡq hvq Zv ḡbḡRI RvbḡZ cvii bv| kixiPPḡḡZv tKej gḡLi ḡbḡḡK m^ḡúY^ḡnq bv, Aḡfḡz/ tmLvḡb AvevK^ḡ nḡq cḡḡ| UvUv ZĒj (Ta Ta) fvlvtK ḡnfwz i AbḡiYRvZ gḡb Kḡi| e^ḡZ ḡeÁvbx WvDBḡbi aviYv ḡQj ZvB|

MāK ḡvkḡKḡ^ḡ i gḡa^h ḡc_vḡMv i, tctḡUv cḡḡy gḡb KiḡZb fvlv GḡmḡQ gvbḡj i ḡmnRvZ cḡḡvRb ev cḡK^ḡZḡ ḡḡK| ḡWḡḡḡUv, Gvi ÷Uj Ges BvvcK^ḡDvi qvbv ḡekḡm KiḡZb th, fvlv GḡmḡQ mgvRex gvbḡj i cvi ḡwi K mgḡSvZv ḡḡK| G mgḡSvZv tKgb Kḡi m^ḡe nj Zv Zviv e^ḡL^ḡ Kḡi b ḡb|

fvlvi DrciĒ m^ḡúKḡ K_v-Kvbx

ḡek kZḡK Gḡm BZvḡj q fvlv ḡeÁvbx UḡḡeU ḡp AvfḡZ e^ḡ Kḡiḡb th, ḡe fvlvi B Dm GK Ges ḡZvḡ iḡKvḡ^ḡḡḡj I fvlvi Dm m^ḡúKḡ evBḡḡj i Mḡi ḡekḡm Kiḡj b| G Mḡi evj nḡḡḡQ th, e^ḡevj xqvbv GKUV Dḡḡḡbvi ḡwi KiḡZ i iḡKij hv ḡKbv GKmgq ḡMḡK ḡú^ḡKiḡZ mḡḡḡ nḡe| ḡeavZv gvbḡj i G ḡa^ḡK mn^ḡ Kiḡj b| ḡbgḡZv^ḡ i GḡK Aḡb^ḡḡK eḡ^ḡevi fvlvtK Zḡj ḡbḡj b ḡZvḡ Ges Zviv AvevK nḡq ḡLj, Zviv GḡK Aḡb^ḡḡK eḡḡZ cviḡQ bv| dḡj fvlvi kv^ḡ nḡmḡḡ Zviv ḡḡbvi ḡwi cḡḡvRḡb ḡbḡRḡ^ḡ i gḡa^h tevSvcovi kv^ḡ I nḡvḡj | fvlvi ḡeifb^ḡZv Zvḡ^ḡ i Qvḡḡḡ ḡj bvbv ḡḡK| e^ḡZ G Mḡi ḡḡ ḡeifb^ḡRbḡMvōxi Rb^ḡ fvlv e^ḡPḡ^ḡ mḡḡi mZ^ḡKB cḡZōv Kḡi|

cāvY RMḡZ ci cvMLiv th aḡvb ḡwi Kḡi Zvi %e^ḡPḡ^ḡ j ḡḡ Kievi gZ bq| ḡḡi YvZxZ Kvj ḡḡK Kḡḡ, teovj, evN ev ḡmsn WvKvWvK KiḡQ cḡḡ GKB iKḡḡ| GK_v mZ^ḡ th, ci cvML^ḡ i fvlv nvRvi eQḡi cvii e^ḡZḡ bv nḡj I gvbḡj i fvlvi cvieZḡ nḡ^ḡQ ḡḡḡMZ|

ḡvbK Ges Kvj K e^ḡeaḡb fvlv

ḡvbK I Kvj K e^ḡeaḡb gvbḡj i fvlvi ḡeKvK I e^ḡPḡ^ḡ NtU| cvieZḡKxj ZvB fvlvi gḡ- kv^ḡ I m^ḡe^ḡebv wntmte KvR Kḡi| GK^ḡ K ḡḡK fvlvi GB cvieZḡKxj Zv fvlvi DrciĒi gZB inmḡḡ| Ab^ḡḡ K ḡḡK G K_v ḡó th, fvlv gvbḡj i bvbv KgRvḡḡKB aviY I enb Kḡi| KvḡRB gvbḡj i KvḡRi cvieZḡbi mḡz mḡz fvlvi I cvieZḡ NtU| kḡai e^ḡenvi I evḡK^ḡ i ḡvcbvḡ ḡe^ḡḡm^ḡMi I exieḡj i ḡZj ḡḡYxq| gḡḡḡb I Rxebv^ḡ ḡ^ḡḡm Zḡ^ḡ i c^ḡ i Pbvḡ ḡḡ Kvj e^ḡm^ḡ| tkK^ḡḡc^ḡqv^ḡḡK eḡḡZ AvRḡKi BḡiR cvWKḡK UvKv- ḡḡābxi m^ḡv^ḡḡ ḡbḡZ nq, Pmvi ḡZv Avḡ ḡi mnRḡeva^ḡ bq|

ḡeÁv I cḡḡḡ^ḡ i kv^ḡ i cḡḡ^ḡ fvlvi DrciĒi inm^ḡ Dḡb^ḡPḡḡ Lḡ GKUV KvḡRi nḡZ cviḡ Ggb fivevi AeKvK tbB| Avmḡj gḡLi fvlvi th iḡc^ḡḡ gvbḡy aḡi ivLḡZ cviḡ ḡb, Zvi Mob I Pj b^ḡḡz ḡbḡḡ m^ḡ I ZĒj ḡwi Kiv K^ḡWb| KvḡRB gvbḡy hLb ḡj LḡZ i iḡKḡi ZLb ḡḡK^ḡ m^ḡZ^ḡ K^ḡḡi ḡeÁv m^ḡḡZ Dcvḡḡ fvlvi DrciĒ m^ḡúḡK^ḡḡḡḡḡ Pj ḡZ cviḡ| KvY ḡj L^ḡ fvlvi cḡ^ḡḡK Z^ḡ ḡjv Avs^ḡK nḡj I gvbḡy aḡi ivLḡZ tctḡḡQ|



Գրքի գլուխ 1.1

A) Գրքի մասին Գրքի մասին

1. Գրքի հեղինակը ովքեր են Գրքի հեղինակը և Գրքի հեղինակը?
2. Գրքի հեղինակը ովքեր են Գրքի հեղինակը և Գրքի հեղինակը |
3. Գրքի հեղինակը ովքեր են Գրքի հեղինակը և Գրքի հեղինակը |
4. Գրքի հեղինակը ովքեր են Գրքի հեղինակը և Գրքի հեղինակը |

cW 1.2

thvM̄thvM̄ gvaᶒg w̄nt̄m̄te fvlv

Dᶒᶒkᶒ

GB cW tk̄t̄l Av̄c̄wb-

- thvM̄thvM̄Mi gvaᶒg w̄nt̄m̄te fvlvi Kvh̄R̄i w̄ Kᶒ,tjv w̄b̄t̄`R̄ K̄iᶒZ cviᶒteb Ges
- fvlvi eᶒenw̄i K Dc̄thvM̄Zv c̄h̄t̄½ A_ᶒqZvi ᶒiaᶒj:eᶒvLᶒv K̄iᶒZ cviᶒteb|

fvlv Kx̄ l tk̄b? Gme c̄k̄k̄ Reve LᶒᶒZ w̄M̄t̄q Av̄ḡiv fvlvi Drc̄w̄Ē m̄ᶒúw̄K̄Z b̄v̄b̄v ZᶒĒj l gZer̄t̄ i Dᶒj̄L̄ K̄tīw̄Q| Gme ZᶒĒj l gZer̄ eūjvst̄k̄ Ab̄ḡv̄b̄ w̄b̄f̄P̄, ᶒeÁv̄wb̄K̄ Z_ᶒ ᶒv̄iv m̄ḡw̄_Z̄ b̄q| Zte c̄t̄iv̄ᶒ|f̄v̄te Av̄ḡiv G m̄ᶒZᶒ Dc̄b̄x̄Z n̄ᶒZ c̄w̄i th, fvlv m̄v̄ḡw̄RK̄ ḡv̄b̄j̄l i B m̄ᶒó Ges GKv̄š̄f̄v̄te Zvi c̄ᶒqv̄R̄t̄b̄B m̄ᶒó|

thvM̄thvM̄ gvaᶒg w̄nt̄m̄te fvlvi f̄iḡK̄v̄

fvlvi msÁv̄ w̄b̄ḡP̄ K̄iᶒZ w̄M̄t̄q w̄K̄QᶒᶒsLᶒK̄ fvlv̄eÁv̄bx̄ fvlvi aᶒv̄wb̄Zv̄w̄ĒK̄ w̄ K̄w̄Ūi l ci m̄ḡw̄aK̄ ᶒiaᶒj̄ Av̄t̄iv̄c̄ K̄t̄īQ̄b̄| Zᶒᶒ i ḡt̄Z, fvlv ḡv̄b̄j̄l i ev̄K̄ᶒZᶒᶒ ½ m̄ó aᶒv̄wb̄ m̄ḡw̄ó hv̄ Zv̄t̄ i cvi ᶒúw̄i K̄ thvM̄thvM̄Mi K̄v̄R̄w̄Ū m̄ᶒúw̄b̄eK̄t̄i| Avevi Ab̄ᶒ GK̄w̄Ū ᶒj̄ ḡt̄b̄ K̄t̄i b̄ th, A_ᶒn̄Zv̄B̄ fvlvi c̄ᶒv̄b̄ ᶒeik̄óᶒ Ges G K̄v̄iᶒȲ aᶒv̄wb̄ Drc̄b̄ēv̄v̄ K̄t̄i l A_ᶒn̄ thvM̄thvM̄Mi K̄v̄R̄w̄Ū K̄iv̄ P̄t̄j̄ | Ḡt̄i i ḡt̄Z aᶒv̄wb̄ b̄q, f̄w̄½B̄ fvlvi c̄ᶒv̄b̄ w̄ K̄w̄Ūt̄K̄ w̄b̄t̄`R̄ K̄t̄i |

eᶒv̄K̄iȲw̄eᶒ`t̄ i K̄v̄t̄Q̄ fvlv n̄ᶒᶒQ̄ ḡlᶒZ̄ w̄ek̄ó f̄ve c̄k̄v̄k̄K̄ KZᶒ,tjv w̄b̄q̄ḡv̄b̄ᶒZ̄x̄ᶒm̄sM̄V̄b̄ l eᶒȳc̄w̄Ēi m̄ḡw̄ó| m̄w̄n̄Zᶒ w̄b̄t̄q̄ h̄t̄i i K̄v̄R̄ Z̄v̄iv̄ eᶒt̄j̄ b̄, fvlv n̄ᶒᶒQ̄ m̄ᶒēb̄ᶒᶒl̄k̄āḡv̄j̄ v̄ hv̄ GK̄w̄Ū m̄ᶒᶒsn̄Z̄ th̄š̄v̄ᶒK̄ f̄v̄eᶒt̄K̄ Z̄t̄j̄ aᶒt̄i| GK̄R̄b̄ Av̄w̄f̄av̄wb̄t̄K̄i K̄v̄t̄Q̄ fvlv A_ᶒȲw̄Z̄ k̄t̄āi B̄ GK̄w̄Ū Z̄v̄ij̄ K̄v̄| Ḡ k̄āᶒ,tjvi c̄ᶒZᶒt̄K̄i B̄ ᶒZ̄š̄j̄:eᶒȳc̄w̄Ē, A_ᶒᶒl̄ B̄w̄Z̄eᶒᶒ iᶒt̄q̄t̄Q̄| GK̄R̄b̄ c_ᶒv̄ix̄i w̄eᶒteP̄v̄b̄q̄ fvlv n̄ᶒᶒQ̄ GKv̄š̄f̄v̄te eᶒenw̄i K̄| K̄v̄iȲ c̄ᶒZ̄w̄ t̄bi thvM̄thvM̄Mi K̄v̄t̄R̄ fvlv B̄ Zvi c̄ᶒv̄b̄ Aeᶒj̄ ᶒb̄ w̄nt̄m̄te K̄v̄R̄ K̄t̄i |

fvlvi ᶒeik̄óᶒ c̄k̄v̄k̄K̄ w̄eᶒf̄b̄ōi K̄

Dc̄t̄i i msÁv̄,tjv Av̄s̄w̄k̄K̄ m̄Zᶒt̄K̄ w̄b̄t̄`R̄ K̄t̄i| K̄v̄iȲ Ḡt̄ i c̄ᶒZᶒK̄w̄Ū fvlvi GK̄-GK̄w̄Ū w̄eᶒt̄k̄l w̄ K̄t̄K̄ c̄k̄v̄k̄ K̄t̄i| Ḡ w̄ Kᶒ,tjv̄t̄K̄ Ḡf̄v̄te Z̄t̄j̄ aiv̄ hv̄q-

- thvM̄thvM̄ gvaᶒg w̄nt̄m̄te fvlv m̄v̄ḡw̄RK̄ eŪt̄bi c̄ᶒv̄b̄ m̄F̄|
- ev̄K̄ᶒZᶒᶒ ½ m̄ó aᶒv̄wb̄ ev̄ aᶒv̄wb̄m̄ḡw̄ó G m̄F̄w̄Ū i P̄b̄v̄ K̄t̄i |
- A_ᶒn̄ thvM̄thvM̄Mi K̄v̄t̄R̄ aᶒv̄wb̄ GK̄ḡv̄T̄ gvaᶒg b̄q|
- fvlv KZᶒ,tjv w̄b̄q̄ḡv̄b̄ᶒZ̄x̄ᶒm̄w̄v̄wb̄K̄ c̄ᶒᶒqv̄ t̄ḡt̄b̄ P̄t̄j̄ |
- aᶒv̄wb̄i m̄v̄v̄t̄h̄ᶒ m̄ó k̄āḡv̄j̄ v̄ m̄ᶒsn̄Z̄ f̄v̄eᶒt̄K̄ Z̄t̄j̄ aᶒt̄i B̄ cvi ᶒúw̄i K̄ thvM̄thvM̄Mi K̄v̄R̄w̄Ū K̄t̄i |
- fvlv ḡj̄-Z̄ k̄āḡv̄j̄ v̄i B̄ w̄ek̄v̄j̄ R̄M̄r- Ḡ k̄āᶒ,tjvi c̄ᶒZ̄w̄ t̄bi eᶒen̄v̄t̄i b̄v̄b̄v̄ Aᶒ_ᶒA_ᶒᶒq̄ n̄ᶒq̄ l ᶒv̄|
- fvlv GKv̄š̄f̄v̄te eᶒenw̄i K̄ c̄ᶒqv̄R̄b̄ w̄m̄x̄ K̄t̄i |

Avgiv fvlvi th w`K_s,tjvi K_v etjwQ Zvi tKvbuUB fvlvtK cwi cYpfc msÁvngZ KiþZ
cvti br| cŰtgB aiv hvK, fvlvi D`Pvhw`KwUi K_v| fvlvi K_`ifcW aYub ubFp ntj I
tKej aYubB fvlvi eugwŕK ifcW aviY KiþZ cvti br| aYubþK Aej þb br Kti I A_@n
thvMþhvþMi KvRwU m=ubantZ cvti | Aci w`þK, fvlvi I ci evKiþYi Rei`w`Iþtj br|
Rxešl fvlvgrŕB μgvMZ beZi c_ ubgŕY KiþQ| wKŠ`Zey K_v I tj Lvq ktāi mpsnZ
web`m k;Lj iŕv Kti Pþj etjB Zv A_@q ntq _vtK| evKiY G k;Ljv iŕvi
KvRwUþZB Zrci _vtK|

**fvlvi aYubgq I
cŰxKx ifc**

K_` fvlviwZ GKvšfvtB evKcŰ`½ mþ aYubþK ubtq Mto IþV| tjL`ixzi tŕtŕ
KZ_s,tjv tjL` cŰxK aYubi RvqMv`Lj Kti| Avgvt`i`kŰ Bw`q G cŰxK_s,tjvtK
cŰ`ŕ Kti| Avgvt`i D`PwiZ aYub_s,tjv hLb kã Ges cŰxK_s,tjv eY`Zwi Kti ZLbB
Zv fvlvi PwiwŕK`enkó`þK aviY Kti| kã_s,tjv Avmtj t`^QvcŰYwv`Z- GKwU mgvR-
tMvôþZ Zviv GK GKwU weikó fie ev A_þK cŰKvK Kti| e³v wntmte Avng th fveW
cŰKvK KiþZ PvB tkþZvi gþb tm fveW tctŰQ t`IqvB ktāi KvR| KvþRB kã_s,tjv
evtK`i Aek`A½| aYub ev aYubmgwó ktā web`-Íntq A_@KvK K ntq IþV|

fvlvi A_@qZv

kã_s,tjv A_@q ntj I GKwU cwi cY`fve ev A_`cŰvtk mŕlg nq br| Avng hv` ŐLkŰ
bvþgi GKwU kã D`PriY KwI Zvntj LkþK ubtq Avgvi tkþZvi gþb cwi cY`tKvB
cŰZwquv Mto DVþe br| Aci w`þK hv` emj, ŐLkŰZvi cŰZþK Av`i KiþQŰ ZLb Avng
hv ejþZ PvB Zvi GKwU cwi cY`Qme tkþZvi gbþK Awakvi Kti tþe| aYub thgb ktā
web`-Íntq wK tZgub kã_s,tjv web`-Íntq GKwU cwi cY`Qme`Zwi Kti| Avi ktāi GB
web`-I ifcW nj evK`|

Avgiv fvlvi PviwU Dcv`vtbi K_v etjwQ| Gi mþ½ Avi GKwU Aek` Dcv`vb nt`Q
A_þeva Ges GB ŐA_þK Aþ`i KvþQ tctŰQ t`Iqv| cŰtgv³ PviwU Dcv`vb tkþlv³
Dcv`vtbi Aaxb| G me_s,tjv Dcv`vbB fvlvi Dþk` ARþb Acwivhþ Dcti th
A_þevþai K_v ejv nj Zvi fvlvZwEþK bivwU nt`Q evM_@Semantics| G c`wU GþmtQ
MþK Semaino (Tomean) t_þK| evM_`Qvov cŰKZ.Aþ_`tKvB fvlv tþB| hv wKQwv`þq
A_`terSvB- K_vq, tj Lvq, fivþZ A_`er cŰþK, G meB evMþ_þ Ašfþ`| KvþRB fvlv
tKej KEvbtmZ aYub ev tgšwLK cŰKvþki msKxY`cwi mþi mngZ bq| gvþexq cŰ`þ½i
mivvþh` mþ I MpxZ aYubB tgšwLK fvlvi`w Aek` w`K Ges G cŰquvi ga` w`þqB
A_`eY`hvMþhvM NþU|

cvþVvEi gj`vqb: 1.2



A) msuŕB DĒi cĕce

1. fvlvi aYubZwEþK w`KwUi_s,iaz;evL`v Kiab|
2. evL`vmþŕ fvlvi weþkl w`K_s,tjv ubþ`R Kiab|
3. fvlvi Dcv`vb_s,tjv Kx? G_s,tjv Kxfvþe A_@q ntq IþV?
4. tgšwLK fvlvi`enkó` w`bifcY Kiab|

cW 1.3

fvlvi Kvr

Dt'k

GB cW tk'f Av'cib-

- fvlvi wwf'bglyx Kv'Ri eY'v w'z cvi'eb Ges
- fvlvi Dcv'vb l fvlvi Kv'Ri Av'stm'úK'e'vL'v Ki'z cvi'eb|

fvlv l mf'Zv

fvlvtK c'qk Ggb GKw bM'ii m'f_ Z'z'bv Kiv nq; th bMi'w wbg'fY c'Z'Kw gvb'ly GKw K'ti B'tUi thv'Mvb w'tq'Q| fvlvi lci me'R'bx AwaKvi c'ht'z G Z'z'bwL Zurich'e'f' fvlvi m'tz gvb'ly i m'ú'K'P w'beo'Zv tev'Sv'z L'w'Z'g'vb bv'U'Kvi 'eb R'bmb e'tj'w'tj'b, fvlvi ga' w'tq GKw gvb'ly i m'tz Avi GKw gvb'ly i c'KZ.c'w'Ptqi m'f'w M'to l'fV| Z'w K_vq, GKw gvb'ly i m'tz hLb Av'j'vc Kwi ZLb t'Kej Z'vtK w'P'bt'Z cvB|

fvlv l mf'Zv G`w' G'tK Act'ii M'v'q-w'c't'v t'j'fM Av'tQ| e'z fvlvi `c'f'YB mf'Zvi c'KZ. 'f'c'w' w'e'w'z nq| fvlvi AM'hi c't_B mf'Zvi w'f'Z w'bg'z nq| e'z gvb'eq Av'P'i't'Yi g'j- m'f'w M'z fvlvi g'ta'B Ges fvlvB gvb'eq Av'P'i't'Yi w'e'P'w'Z c'K'v'ki K'v'h'Ki g'ra'g w'nt'm'te K'v'R K'ti |

fvlv c'w'e'Z'bk'xj | t'k l K'v'j'v's't'i G c'w'e'Z'B Ae'v'n'Z i't'q'Q| fvlvZ'Ej Z_v fvlvi w'e'Z'f'bi w'bg'_t'j'v ZLb m'g'w'RK'f'v'te Zurich'en n'tq l'fV hLb Zv gvb'ly l Zvi mf'Zvi m'tz m'ú'K'm'f' Z'w'i Ki'z cv'i | fvlv gvb'ly i g't'LB t'd'ti Ges gvb'ly i g't'LB Zvi c'KZ. R'x'eb'x'k'w'z t'c't'q _v'tK| Kv't'RB fvlvi w'bg'_t'j'v Z'w'i Ki'z t'm'tj gvb'ly i R'x'eb'v'P'i'Y't'KB m'ev' Av't'M w'e't'e'P'bv Ki'z nq|

fvlvi MYZw's'KZv

fvlv GK'v's'f'v'te'B MYZw's'K| K'v'i'Y Zv gvb'ly i g't' g't'L t'd'ti Ges Zvi M'g'bv'M'g't'bi c_ A'ew'w'Z| A'ci'w't'K, m'w'n'Z' A'w'f'R'w'Z'K, K'v'i'Y Zv m't'e'f'eg g'bv'l'v'tK av'i'Y K'ti | m'w'n'Z' A_s'Y'w'Z gvb'ly i g'ta' w'K'Q'g'vb'ly i K'v'R h'v'v' e'w'x l g'b't'b AM'hi | R'b'w'c'q' m'w'n'Z' A'bv'w'g'K n'tj l Zv e'v't'v'q'v'ix b'q| G t'q'f'f' b'v'g'w' AR'v'bv _v'K'tj l m'ö'vi A'w'Z'f'K A'f'K'vi K'iv h'v'q b'v| t'm'B m'ö'v t'Kej Zvi P'v'ic'v't'ki gvb'ly i f'v'e-f'v'e'bv'v'v' D'P'v'i'Y K't'i't'Q'b| fvlv m'K'tj i B A'wa'K'v't'i i e'f' K'v'i'Y Z'v't' i g't'LB fvlvi R'M'r w'e'Z' | g'v-e'v'v'v' Zvi m's't'b'm's'h'z'f'K, w'k'q'K Z'w'i Q'v'f'f' i, t'b'Z'v Z'w'i A'bv'v'v'v'f' i- t'g'v'U K_v, m'g'w'RK gvb'ly i v'w'bg'ZB G't'K A'ci't'K fvlvi m'e'K w'tq h'v't'Q'b| gvb'ly i cv'i _ú'w'i K m'n't'h'w'M'Z'vi m'e't'P't'q De'f' t'q'f'f'w n't'Q fvlv|

g'v'be'x'q Á'v't'bi e'v'n'b w'nt'm'te fvlv

fvlv g'v'be'x'q Á'v't'bi A'c'w'i n'v'h'g'ra'g l e'v'n'b w'nt'm'te K'v'R K'ti | t'g's'w'LK l 'j'w'LK fvlvB G`w' K'v'R K'ti P'tj'f'Q| g'v'be'x'q Á'v't'bi c'v'R e'w'z, t'k l K'v'j't'K A'w'Z'p'g K'ie'v'i k'w'z av'i'Y K'ti fvlvi ga' w'tq'Q| G'gb w'K, Av'g'v't' i m's'w'Z. l H'w'Z't'n'i D'cv'vb w'nt'm'te w'k'f'K'j'v, f'v'h'g'm's'M'z G'm'e'l fvlvi m'v'v't'h'v'v' t'eva'M'g' n'tq l'fV| w'j l b'v't'f' t'g'v'v'w'j m'v i n'm'g'q'x

ntq I tV evPibK cKviki gungvq, Rqbtj i , YUvbr guj riv Rxeb-thv xiv ntq I tV hLb K_v i guj vq I t` i eS tZ I tevS tZ P vB| Ab` K_vq, gnr ik i KgP ntq I tV fvl vbfP|

veAvb I chnj i AMhv i v gibe Rvzi Rxebe`e`ri DrKIMZ th vekvj m`tebvtK AvfvvMZ Kti tQ Zvi c dvtZ i tqtQ `B ev eu gvb t i ci`ui mnthvMx Kk j x nvZ I m j o k x j cAv| fvl vB G t q t i gvb t K ci`ui mnthvMx Kti tZvtj | tmB KteKvi vLtoi R t b i I Av t Mi ` q K g r i veAvb xiv hvv fvlvi gva`tg vbtR t` i gta` vP s i i veibgq bv NUvtZ cvitZb Zintj vgt i i vci v g W v P i K v t j i ve`sq ntq AvvefZ nZ bv| e`Z fvlv gva`g vntmte K v R bv K i t j g i b e x q cAv I K k j Z v i ` i v b v s i i , K v j v s i i I DrK I v K v b v U B m`e v Q j bv Ges GLv t b B g v b t y I c d Y x i g t a` t g s j e`e a v b i v P Z n t q t Q |

fvlvi kv3

fvlvi Avdh`Rv`gtj B tmB Avv`Kvj t` tK AvR t Ki v` b chS i g v b t y b v b v K g t i A v b t R t K e`v c Z t i t L t Q | R x e b P j v i G K v W e o k v 3 v n t m t e K v R K t i t Q f v l v | A v g i v h L b t K v b v f b e f v l v f v l v t` i g t a` c t o h v B - Z v t` i f v l v e y S b v G e s v b t R t` i I t e v S t Z c v i i b v Z L b v b t R t` i t K g b A m n v q g t b n q |

fvlv me`v i e`v c K | g v b e x q v e`v , m v n Z` I ` k B , t f S Z v e A v b , c`v ` v e A v b , b Z E j G t` i v e t k l t K v b G K v U i c v i m t i f v l v i c`P v i Y v m v g Z b q | A v t b i g v a`g v n t m t e f v l v m e e`v i B A v a o v Z v | f v l v e A v b x t g v i I t c B f v l v i A m v a v i Y k v 3 i K _ v e t j t Q b G f i t e -

It is the conveyor, interpreter and shaper of mans social doings. It enters into influences, and is in turn, influenced by every form of human activity without exception. Its functions are as numerous as the field in which human ingenuity operates.

fvlvi cvieZB kxj Zv

Avgiv hv`v K Q y K v i e v f i v e f v l v i I c i Z v i c f v e c t o | G U v m Z` t h , t K v b e`v 3 h L b Z v i e 3 t e` c v i e v Z v e l q e`v e v c h t i 1 2 i A e Z v i Y v K t i Z L b Z v i g l y f v i 1 2 , A 1 2 P i j b v G e s G g b v K i m t e v t a i l c v i e Z B N t U | A v g i v R v M v Z K e v A v a`v v Z v K , L y m v a v i Y e v g n r t h t K v b K v t R A v g i v e`v c Z n B b v t K b Z v i g a`v t q A v g v t` i f v e f i e b v i I c v i e Z B N t U | d t j t m B f v e f i e b v i v e i b g q K i t Z v M t q k a`v b e P b , e v K` M B b v G m e l m g v M Z c v i e v Z v n t q h v q |

cvievi I eqEi mgvR cvietek fvlv

cvievi Ges eqEi mgvR cvig dtj Avgt` i cv i`u v i K m`u K v i t I P v i v i t K `e v k o` v b i j c t Y f v l v A v d h`k v 3 a i n v v Z q v i v n t m t e K v R K t i | c v i e v i R x e t b v b Z v s i N t i v q v c v i e t e k t h f v l v e`e u Z n q A v b g v m b K c v i e t e k i f v l v i m t 1 2 Z v i v g j L g t Z h v l q v v e o a b v g v t | c v i e v i K m`u K v i t I f v l v `e v P i` j q | Y x q | G K B v e l t q e v c h t i 1 2 v c Z v - c t i A v j v t c i f v l v , `y t e v b e v `y f v B t q i A v j v t c i f v l v q v e i v f b a z v v t K | v c Z v i K t E i m t 1 2 e`e u Z k a v e v j I v c Z v t K G e s f v B e v e U z k a v e v j I t` n f v i 1 2 m n t R B v c Z v , f v B e v e U z K v P i b t q t` q | f v l v G t q t i m`u K v i t I P v i v i t K `e v k o` v b Y e q K v h R i f i g K v q A e Z x Y e n q | A c i v` t K , c v i e t e k t f t` e`v 3 Z v i f i e e j q m v o t Z f v l v t K B n v v Z q v i v n t m t e e`e n v i K t i | v c d R t b i m v b t a` A v K v v L Z c v i e t e k m v o t Z f v l v i K v R B m e v a K , i a z j t c t q h v q | A v e v i G K B e`v 3 i m t 1 2 A v d m K t q f v l v i t h c v i c v U , K`v t d t Z e t m f v l v i t m A v U m v l e t a b v k v _ j n t q h v q |

cĕv` I cĕPb

wełkl wełkl kĀ, e^{v3}, e^v ev ĩtbi bvg AłbK mgq BwZnvłmi cjtbr Aa^vqłK Avgvł`i ĩpłZ DłbłłZ Kłi| cĕv`-cĕPbł BwZnvłłK nviłtq thłZ ł`q bvl evsıvq WłK I Lbvi ePłb łtqtQ eŭKvłji AwfĀZvi mĀq| W. gıy^s knx`jvn& etj łQb, Őwłtoq etm łctovi LeiŐ- GB cĕv` evK^uł tmB mgłqi K_v ĩY Kwiłq ł`q, hLb cıŪqv etłzi ivRavbx łQj | Phłct`i ŐAvcbv gvłm nvi bvl ĩeix (fłłK), fviZPł`ı ŐbMi cıvłtq ł`evj q łK Govq?, ŐeoiłciłłZ evıj i etal/łłY nıłZ ĩwo łłY łK PłłŐ (Abĕvb) Gme GLb cĕPb hv bvl cvıı ĩZ I cłłł Avgıv etj ĩłK|

**fvlvi I ci ag^ofvlv
ıelqK Młševj i**

wełkji tełki fvlm fvlviB cĕPxbZg łb`kŐ nł"Q ag^oev Aa^vZłmvabv ıelqK Młševj | AłbłK głb Kłi, łjL^ıłłZı Awefłe NłłłQ agvłq ıeavbłK ĩvqıfc ł`ı qvi cĕPŐv ł`łK| fvlv AłbK łłłł agvłq ıekłm I ms^ıłZı cłłxK nłtqtQ| łıvgvb K_vłj Kł`i j^ıłłb, gıjıgvł`i Avııe, tešxł`i cvıj -cĕKZ, Bŭıł`i ıneł agvłq ıeavb I ms^ıłZı evnb nłtqtQ| wełkji AłbK mgx fvlvi KZFY kĀevıj GłmłQ agvłq Młš` I ıeıa ıeavb ł`łK| AłbK łłłł G_vłjvi A^oevPł^ı NłłłQ| Avııe ıbqZ, dıR, Kvłqg, eıvZ, Bgvb BZ^{ıı} kĀ Avgvł`i cłłZı łbi KıR bıv cłłł e^ıŭZ nł"Q| BšłıR Disciple, Dean, Syllabus, Lecture Gme kĀ atg^o MıD Őıvłtq łkłv cłłł e^ıŭZ nł"Q|

ıeĀvb I cłłł ıelqK ıekıj kĀfıvıi GLb AvšRłłZK| fvlvi e^ıevb Kıvłq G kĀ, łjv Avgvł`i mgq I kłłK eŭıvłk jvıNe KłıłQ| mıvııłłZK Kıvıi KıvıDUvi, BıvıłbU, B-tgBj, łgvłWg, łłł GLb ıekRbıx kĀevıj | ıeĀvbı, cłłł ıe^ı, cĕKškj x I ıPıKrmıeĀvbıv G łłłł AMıx fıvgKıv AeZıYłtqtQb|

fvlv I ıkłv

ıkłvi ıekıj Ałłb fvlvi cłłv ł`š`Ő| me ıkłKKB fvlv ıkłK- G ePb GLb cĕPłbi Kıv³ ARŐ KłıłQ| ıkłvi KıR cıjıcvıB łgšłK I ıjıłZ fvlv ıbFł| łKlv I łKlvıbı me cłłqB fvlvi AwıacZ^ı GK^ıŐł| cłłłZ, Dc^ııcbv I gj^ıvqb G me Kıvı ıkłK- ıkłv^ıłgšłK I ıjıłZ fvlv-łKškj cłłvM Kłıb| fvlv łKej fvlv ıkłłKı AwıKvłıi RMr bq, MıYZ, ıeĀvb, mgıR ıeĀvb BZ^{ıı} me ıelq Āvłbi cııłtekbv I Abııj łb fvlvi e^ıenvı Acıııvıh^o



cıłVłĒı gj^ıvqb 1.3

A) msıłłB DĒı cłłe

1. mf^ıZvi μg DĒıłY fvlvi fıvgKı Kı?
2. fvlv GKıšfıvıe MYZııšK| e^ııL^ıv Kııb|
3. Āvłbi gıv^ıg ıntmıe fvlvi KıR_v łjv Dłłı Kııb|
4. cıııevı I mgıR Rıełb fvlvi wełkl fıvgKı ıbıfcY Kııb|
5. ıeĀvb I cłłł ıelqK kĀevıj i AvšRłłZK nłtq I Vıı KııY Kı?

ejv mefak ,iazcy` 7Zv wntmte mefak Rulj c0uqv wntmte cwimuyZ | KviY, Kx
ejtZ nte Zv thgb fvetZ nq tZgub ejvi mt½ mt½ fvebvi wePT c07cy e3vi
kviwi K I gvbumK c0uqvi cwipq enb Kti |

**ejvi t7t7i wetkl
thvM'Zvngn-**

0ejv0` 7Zvi t7t7i wntmte thvM'Zv,tjv AvRZ nta`vK:

tk0Zv m7PZb- e3 tk0Zv kviwi I gvbumK Ae`v I Ae`vb m7utK`mAvbZv c0k0
Kiteb | tk0Zvi eqtcwi mg, wk7vi `li, kviwi I gvbumK c0uz G t7t7i j 77yq weiq |

e3vi wetqi c0m7KZv I DcthvM'Zv- GuU tk0Zvi mAvbZvi GKiu wetkl w`K | ce`
cwivuz I AvfAZv Gt7t7i e3vtK mnvqv Kti | e3v I tk0Zvi u`zvcy`m7uKp
(Rapport) GKvš'Kvg |

avib mAvbZv- ejv GKvš'fite D'Pih`etjB avibi mgzd'PviY I `fwiži h_v_Zv
Avek`K | e3vi D'PviY gvbm7ubGes `fwiži e3te`i A`cKvšk mnvqv Kiteb |

kā vebPb- e3e` cKvkK DcthvMx kāvevj e`envti m77g ntZ nte | kāvevj weiqvby
nte Ges ktāi c7ivejE cwivvi KitZ nte | wetklYeipk kāvevj i e`envti mZKZv
Kvg | cwivvi k kāvevj i t7t7i h_v`I MpxZ kā vebPb KitZ nte | iaMe I
AvZe`eüz kā cwivvi Kiv evAbxq |

evK` f7teiwelqe`i thšvK veb`im- e3v Zvi Ku_Z evK` ci`úivq fviemsMvZ eRvq
ivL7Z cviteb | Gt7t7i weiqe`i mōz h_v`Dc`vcb Kvg |

c0qvRbxq hyb, `qvš' I Z` c0vb- e3te`i mg_7b c0qvRbxq hyb, `qvš' I Z` c0vb
KitZ nte | c0qvRb wetkl Zt`i c7ivejE KitZ nte |

e3te`i wetkl w7ki Ici tRvi c0vb- e3v Zvi e3te`i wetkl w7ki Ici tRvi
t`teb | GuU tk0Zvi `vZtZ avit7i mnvqK nte |

Dīxc7ki `evPī` m7p- `7i c0qvRbxq I vvbvqv, m77KZ I BsvMZ, t`nfwiž BZ`w`
DīxcK wntmte kvR Kti | Dīxc7ki `evPī` e3e`7K AvKI7xq I M7YthvM` Kti tZvtj |

tmšRb` c0k0- tk0Zvi c0Z tmšRb` c0k0b kvjxbZv I cwivuz iavpi cwipq w7z
nte | Avjxb gšé, we`ac I ZvQj` e3te`i M7YthvM`Zv I DcthvM'Zv t7xak7i |

cvᄃVvĒi gjᄃvqb: 1.4



A) msᄃᄃB DĒi cĳœ

1. fᄃlᄃ-ARᄃ I fᄃlᄃ-ᄃKᄃY cĳᄃqvi gaᄃKvi cvᄃRᄃ Kx?
2. ᄃkᄃbᄃ I ej vi cvᄃ ᄃᄃi K mᄃᄃKᄃmᄃ ᄃbᄃfᄃY Kiᄃb|
3. ᄃkᄃbᄃ I ej vi KᄃᄃR A_ᄃYZᄃ Acᄃᄃi nᄃhᄃ eᄃᄃLᄃᄃ Kiᄃb|
4. ᄃkᄃbᄃi KᄃᄃR eᄃᄃᄃᄃᄃK Kx Kx ᄃᄃᄃMᄃᄃZᄃ ARᄃ KiᄃZ nq?
5. ej vi KᄃᄃR eᄃᄃᄃᄃᄃK Kx Kx ᄃᄃᄃMᄃᄃZᄃ ARᄃ KiᄃZ nq?

cW 1.5

thvMþhvM gva`g mþmte fvlv: cov I tj Lv

DþI`k`

GB cW tkþI Avcb-

- fvlv-`ŕŕZv mþmte cov I tj Lvi cvi`umi K mþúK@mĤ wþifcY KiþZ cviþeb Ges
- cov I tj Lvi wþkI w`K, þjv Dþj l ceŕ e`vL`v KiþZ cviþeb|

fvlvi`þfc e`vL`vmþĤ Avgiv GK_v tRvi w`þq etj wQ th, gþLi fvlvB wþgŕŕ Kþi fvlvi wFZ&Ges G KvþþYB a`yþbgqZvB fvlvi cKZ.Aw`ZþK aviY Kþi | a`yþbgq ifcU hLb A_gg nq ZLbB Zv thvMþhvM gva`g mþmte Kvþŕi nþq IþV| gvþy Zvi cKþmþK e`envi KþiþQ a`yþb`Zwi i KvþR Ges a`yþb ev a`yþbcþþK cvi`umi K thvMþhvþMi KvþR j wMþq fvlþK Amvavi Y gvþexq cþŕ mþmte Mþo Zþj þQ|

fvlvi a`yþbgq I tj L`ifc

fvlvi tj L` ifcU GþmþQ cþi Ges AþbK cþi | tMwv`þþqv Rþjo KþqK tKwU gvþy wj LþZ coþZ Rvþb bv, wKš`ejþZ cþi | thvMþhvM gva`g mþmte fvlvi gj-`ŕŕZvU Zv`i AvqÉvxb | wki iv fvlvi cv MþY Kþi tkvþv I ejvi ga` w`þq| tj Lv I covi KvþR KiþZ nq ZvþK AþbK cþi | Avi coevi KvþwU GþmþQ fvlvi tj L`ifcU Mþo DVeri cþi | fvlvi a`yþbgq ifcU tj L`ifc cZxKx nþq IþV Ges cZxKx ifcU Avmþj a`yþbgq ifcUþKB aviY I enb Kþi | covi KvþR GB a`yþbB gþy` wþþeþbv tctq`þK | ievU` j vþwvi K_vq-

Learning to speak and understand means learning the language, whereas reading and writing imply that the language is known and that we are learning a graphic representation of it. (Language Peaching, p13)

cov Kx I þKb?

covi msÁv w`þZ wMþq i evUŕ vþWv h_v`B etj þQb,

ŒTo read is to grasp language patterns from their written representation ...Œ G KvþþYB cov tkLvþbvi KvþR coþþK wþþPi avc, þjv cvi nþZ nq:

covi wþþbævc

- covi AvþM a`yþb, þjvi tj L`ifci mþ½ cvi wþþZ;
- tj L`ifc ev etþYŕ mþ½ fvlvi mþþhvM`vcb;
- ejv I covi mþ½ mgšq`wþþb;
- tj L`e`i mie cVb;
- gj-fve I Z` AvniþYi DþI`k` cVb;
- tj L`ifci`wþþĤ`i mþ½ cvi wþþZ;
- kþcþŕ eþx I kþai cþþq wMk`wþþĤ` Abþwþb;
- covq MþZ I`ŕQ` ARŒ;
- mþþZ` cvV: Avþ`vþþZ I tms`hþþtai Ges wþþKvþ mþþb|

K_v etj tevSvZ nte th, cvVK covi e`u cto wKwK etjStQb| wj tLI Zv
tevSvZbv hvq Avi Avgv`i fvlvi cixvqv tj Lvi KvRB teuk| etj thgb
c0kie DEi Kiv hvq, wj tLI tZgub Zv Kiv hvq| AwAKS' Gi ga` w`tq
fvlv`vqv wntmte cov, ejv I tj Lvi tgjeUb NtU hvq| (c0Z`wKx evsjv,
c., 25)

bxi te cov a`wbgq bv ntj I Avgv`i AvbPPP| Abxvj tbi t`v`t GwU Zvrchen| wkvvi
D`PZI chvq bxi te cov Qrov Ptj bv| KviY, bxi te teuk cov hvq Ges gbmsthvMI
ZvtZ teuk nq| cvtV Mfxi Zi Avb`i Dcjmä NtU bxi te Zv PPA ga` w`tq| G Kvi tYB
bxi te covK Aemti i w0m/x ejv nq|

**wevfoi Ktgi cv:
wekI wK**

cov tm mi te ev bxi te tnvK, Zv bvbv i Ktgi ntZ cvti | GB i Kg, tjv wbfP Kti covi
welqe`I Df`tk`i I ci | covi KtqKw i Kg nt`Q-

- wekI Yagr`cvV
- Avb` cvV
- wbeo cvV
- msnZ cvV
- we`Z.cvV|

wekI Yagr`cvV ZEj I Z` wbfP| Abxvj wePvi I djvdj wekI tYi ga` w`tq w`v`st
DcbvZ nl qvi c0qvRb GLv`b teuk| G ai tbi cvtVi Pvj fviw°, axi c` wev`v`c AMhi
ntZ nq cvKtK| cvv`stki i iæ t`tk tkl ch`l cotZ nq ZvtK, fvetZ nq Mfxi Zi
Dcjmäi c0qvRt| G ai tbi welqe`i cwi tekbv j NymAvix bq- kã wbePb I evt`i
AbxvjG Dc`vcbvi t`v`t mZKZv cvv`welqe`i `enkó`| wekI Yagr`cvtVi D`ev w`tV
Ae`vb Avb` cvtVi | cotZ cotZ GKUv fij -j vMv teva cvKtK tctq etm| G ai tbi
cvV cvtKi GKv`st/x- wbtRi fij -j vMv GKv`stfite wbtRiB e`vL`v ev wekI tYi tZvqv°v
Zvi tbB| c0vP Avb`i Dcjmä G ai tbi cvtK e`v`w0 Kti |

wbeo cvV cvKtK cvtVi tfZti c0etki m`eta Kti t`q| gg°Abxv`b GLv`b gly`
wetePbv jvf Kti | Mfxi gbtmsthvMI GLv`b Avek`K| G ai tbi cvV wekI Yagr`cvtVi
KivKivQ ntj I c0wZ-wePti ci`ui `ieZv` msnZ cvtVi mt½ wbeo cvtVi m`uK°
wbKtUi- gj- fveUKZZtj AvbB `tqi j`v`e`| we`Z.cvVtVi welqe`i cwi gvY teuk|
Kv`RB GLv`b `ZZvi c0qvRb ntq cto| AtbK teuk cotZ nq etj B meUKzgtb ivLv
GLv`b Ri`wi bq|

fvlv`vqv, tjvi c0vb`w` ijc nt`Q tg`wLK I `jwLK| ejv I cov g`LiB KvRt
Aciv`K tj Lv fvlvi c0vKx ijcw`K Kv`R jwMtq m`Ax ijcw`K ati ivtL| Zte tj Lv
gv`tb ati ivLv bq, ati ivLvi c0YZvtK mrvqZv Kiv| me tj LvB `wbK I Kwj K
`tZtK AwZµg Kivi mvg_°ivtL bv| wki iv hLb wj LtZ i iæ Kti ZLb Zvi tj Lvi KvR

ṽ Ae GW#Kkb

wb#R t`#L Ges Acit#K t`Lv#bvi Avb>` jvf Kti | tj Lv Zvi fvlv` #Zv#K #WY#Ki Rb`
ntj l ati ivLevi #lgZv w`tq _v#K | tj Lvi m#Aqx w` KuU GLv#bB weaZ |

tj Lv fvlvi c#ZwbaZ; Kti etjB tj Lvi wbZ`w`#bi m#x cov | Ab` K_vq, tj Lv cto
e#tZ nq, tevSt#Z nq | tj Lvi t#t#i Avgiv th thvM`Zv, tjv AR# Kie Zv n#`Q-

tj Lvq cvi`Ob#v- tj Lvi KvM#Ri tKv_v t_#K iiaKie Avi tKv_vq tkl Kie Zv Rvbn
PvB | c#Z`KuU A#iifci MVb m#u#K#m#y#u#o aviYv _vK#Z nte | Uvbn tj Lvi t#t#i G
K_vu mZ` | thgb Lvk tZgb tj Lv P#j bv | k#_tjvi cvi`uwiK d#k, `# jvB#bi
ga`Kvi `iZ; Ab#Q` iiaKivi aiY BZ`w` m#u#K#m#y#u#o aviYv _vKv c#qvRb |

tj Lvi cVb#thvM`Zv- cvi`Ob#v m#z cVb#thvM`Zvi ckuU GKv#f#v#e m#u#z | cV#Ki
covi `v#`i c#Z j # i vLv c#qvRb |

tj Lvq MvZgqZv- tj Lvi MvZgqZv mgq l c#qvR#bi m#z mvgAm`c#n#e | `#ZZv l
MvZgqZv GK K_v bq | MvZgq tj Lv mnR l `v#v#eK, Zv#Z m#z#u# eRvq _v#K |

tj Lvi i#xZv- tj Lv velqybM nte | Ac#m#zK vel#qi AeZviYv tj Lvi gvb#K #Y#eK#i |
m#e#c#i fvl#Yi i#xZvi ckuU i#z#c#y# GvU P#P#l Ab#xj #bi velq |



сџVџEи гџ`џqb: 1.5

A) мsџџB DEи сџџe

1. cov I tj Lvi cvi `úwi K m`úK`bifcY Ki`ab?
2. coџZ џMџq сџVKџK Kx Kx аџc AџZμg KiџZ nq?
3. miџe covi џeџkl џ`K_џj v Kx? e`vL`v Ki`ab|
4. bxiџe covi _i`aџj I Zurich`Aџџj vPbv Ki`ab|
5. џeџkd Yagr`сџV I Aџb` сџџV tgџj сџ`R` Kx?
6. fiџvi сџZxKx ifc џnџmџe tj Lvi џeџkl џ`K_џj v Kx?

fvgKv

MĀK Logos kā t_#K BstīR Language ktāi DrcmĒ | MĀtm Logos 0vīv we`vikw³
 tevSv#bv n#Zv | ms`#Z K_v ejv At_@fvl0 avZzt_#K fvlv kāmU G#m#Q | m#Zivs t`Lv
 hv#Q, fvlv cĀÁUjī m#t_ #PŠ# I cĀKv#ki Mf#i m#úK#i#t#Q | fvlvi m#v#h`B gvby
 Zvi #PŠ#, a`vb aviYv, g#bi fve cĀKvK K#i | Pij m#Gd, n#K#Ui g#Z, fvlv n#Q gvby#i
 Ggb GK Abb`m#f `eikó` (Differentia) hv Ab` cĀYx t_#K gvby#K `#ZŠ; `vb
 K#i#Q | gvby Zvi G gnr `eikó`U n#Rvi n#Rvi eQ#i i #gveKv#ki avivq AR# K#i#Q |
 Abgvb Kiv nq cĀq cĀP j #I ermi Av#M t_#K gvby Zvi R#eb hv#b cvi`úwiK
 thvM#h#Mī t#I#I m#;Lj fvlv e`envi K#i Av#M#Q |

fvlv bvgK thvM#h#M gva`g#Ujī DrcmĒ cĀM#Zn#mK Kv#j i n#j | fvlvRÁvmī m#FcvZ
 n#t#Q A#bK c#i | cĀP#Kv#j cĀq mKj gvbe#M#v#B wek#m KiZ fvlv Ck#i i `vb |
 #gmi#q#` i wek#m #Qj fvlv m#Q K#i#Qb 0_Z t`eZv# tewe#xq#v#v wek#m K#i 0bv#y#`eZv#
 Avi fviZx#v#v etj fvlv `vb K#i#Qb evK#`ex mī`Zx |

ÁvbZmĒK `#ofw# t_#K fvlvRÁvmī m#FcvZ MĀtm | tn#v#v#v#mī iPbvq Zvi cviPq
 cvlqv hvq | cĀP#b fvi#Z cv#Y#b, hv®, cZÁ#j fvlvPŠ#i t#I#I D#j #thvM` bvg | Z#e,
 fvlv#K `eÁvbK `#t#v# I f#w# t_#K ve#k#d#Yi m#FcvZ E#bK kZ#K | fvlvRÁvmī
 Áv#bi GK#U ve#k#l#m#Z kvLv n#Q fvlweÁvb (Linguistics) | G BDib#U fvlweÁv#bi
 Av#j vP` #elq #nt#te #bt#e³ cvV, t#v Aš#f# n#t#Q |

cvV- 2.1: fvlweÁvb

cvV- 2.2: aY#bZĒ;

cvV- 2.3: i#f#ZĒ;

cvV- 2.4: evK`ZĒ;

cW 2.1

fvl weÁvb

Dt`ik`

GB cW tk`l Avcib—

- fvlv weÁvb Kx Zv e`vL`v KitZ cvi`teb;
- fvlweÁv`bi `eÁvnbK wfvE` m`útk`qny` c`k`K KitZ cvi`teb Ges
- fvlweÁv`bi Avtj vP`` nelq l wefvM`_tjv eY`v KitZ cvi`teb|

fvl weÁvb

fvlweÁvb (Linguistics) nj fvlvi weÁvb (Science of Language)| fvlv m`útk`
`eÁvnbK c`xvZtZ Avtj vPbvB fvlweÁv`bi Kvr| fvlv m`útk`Z hieZxq Z`_ D`NvUb
Ges `eÁvnbK c`xvZtZ cVb-cvB l wek`l YB fvlweÁv`bi Avtj vP`` nelq| fvlweÁvb
fvlvi A½ e`et`Q` , fvlvi Aege ms`v`bi k;Ljv Avne`vi l Zvi e`envi c`ijx eY`v
Kti |

fvlweÁv`bi c`xvZ

Avtj vPbv i i`tZ Avgiv fvlvi wek`l tY `eÁvnbK c`xvZ ej`tZ Kx tevSvq Zv Rvbe|
weÁv`bi Ab`vb` kvLvi g`Zv fvlweÁv`bi l Avtj vP`` nelqul mjbv` `| `vk`K `w`f`w` l
`eÁvnbK `w`f`w`i g`ta` GKul tgšj cv`R` GB th, `k` mgM`RMr c`uqv`K ALDifc
M`hY Kti Zv gj`xfZ inm` Abjv`v Kti | Avi weÁvb RvMvZK c`uqv`K ALDifc M`hY
bv Kti Zvi GK GKul w` KtK `Zšjvte wek`l Y l Avtj vPbv Kti | G Kvi tY c`vweÁvb
l Dv`c weÁv`bi Avtj vP`` nelq GK bq| Abjv`c vte, fvlweÁv`bi l Avtj vP`` nelq
mjbv` `: gvb`l i fvlv| fvlweÁv`b fvlv nj gvb`l i evM`h`šj mivv`th` D`Pvi Z ht`_Q
vbe`PZ (Arbitrary) evK` g`ta` wev`e`x`vte veb`_l Ggb KZK`_vj A`_en aYvBMZ c`ZxK
hvi mivv`th` wek`l wek`l RvWZ ev Rb`Mv`xi tj v`Kiv ci`_úti i g`ta` fve veb`gq Kti | G
fvlvB nt`Q fvlweÁv`bi Avtj vP`` nelq|

`eÁvnbK c`xvZtZ fvlv m`útk`Avtj vPbv c`g avc`l nt`Q fvlv m`útk`DcvE` msM`h
Kti Zv`K bv`f` Kiv| c`qvRb Avjv`ti K`_ l tjL` Df`q c`Kvi fvlv t`t`KB Z`_
msM`h Kiv nq| Zte Gt`q`T Avjv`K fvlweÁv`bi K`_ i`vZi w`t`KB tSv`K tekx|
fvlweÁv`b Kv`b i`b Ges w`KQv` `šjZi mivv`th` DcvE` msM`h Kti ivL`tZ cv`ib|
Av`Kvsk t`q`T GB DcvE` Av`R`vZK aYvbgj-K eY`vjvi (International Phonetic
Alphabet) mivv`th` vj`v`c`x` Kti ivL`v nq| tUc`ti K`v`i l Zv msi`qY Kiv nq| c`P`x
fvlv m`útk`Avtj vPbv KitZ ntj H fvlvq vj`wLZ Z`_vej` (Written Record) thgb-
c`P`x c`Z`v`v` (Inscriptions) c`P`x M`S` l c`v` BZ`w` Kv`R jvM`tbv nq| fvlvi
aYvbmgt`ni tiL`vP`T, D`Pvi Y c`uqv` BZ`w` vev`f`v`v` K m`t`U l c`qvRbxq Z`_ msM`h Kiv

nq KvBḫgMōd (Kimograph) Kwġg Zijy (Artificial Palate) G· ḫi dḫUvMōd (X-ray Photograph) cḫwZi mrvvḫḫ | Gfḫte fvlvi bvbv wḫKi DcvĒ msMōh Kḫi fvlveĀvḫbi wōZxq avḫc tm, wj i h_vh_ eYḫv t̄ lqv nq Ges tm, t̄jvḫK wḫkḫY Kiv nq | fvlvi aḫvbZvMĒK wḫKwJi eYḫv l wḫkḫY AvaybKKvḫj AvmḫjvMōd (Oscillograph), t̄-úḫ±vMōd (Spectrograph) cḫwZ. ḫḫšj mrvvḫḫ t̄blqv nq | fvlvi Ab'vb'' wḫK thgb kāmVb, kāifc, evK'wēb'vm BZ'w' wḫlḫq | fvlv wēĀvbx chḫeḫY, Z_ wēb'vm (Processing) l wḫkḫY (Analysis) Kḫib | Gfḫte fvlvi Dcv'vb, wj wḫk- lY Kḫi hLb t̄'Lv hvq th GKB iKḫgi KviY (Cause) _vKḫj evievi GKB iKḫgi dj (Effect) A_ ev GKB iKḫgi cwi w'wZtZ GKB iKḫgi cōZw, wqv t̄'Lv hvḫ'Q ZLb cieZḫavḫc tm e'vcviwḫK mvari YvKiY (Generalisation) Kiv nq | D'vniY-ḫc Avgiv t̄'LtZ cvB th, ms-ḫ. ōKgḫ' cvwḫj tZ ōK=ḫ, ōF³ ō cvwḫj tZ ōFĒ ō nq | G t̄ḫt̄Ā Avgiv G mvariY wḫxvḫšĀ Avmḫj cwi th, wēlge'Āb wḫtq MwZ ms-ḫ. hḫe'Āb, wj (iḫ, ³) cvwḫj fvlvq mge'Āḫb MwZ mshḫ' e'Āḫb (iḫ-gḫ nḫtqḫ gḫ-gḫ Kḫ-Z nḫtqḫ Zḫ-Zḫ) cwiYZ nq | G mvariY wḫxvḫšĀ Avmvi cḫi Avgiv Abgḫv (Hypothesis) KiḫZ cwi th, Abjḫc thvMḫḫvḫMi t̄ḫt̄Ā cvwḫj fvlvq Zvi GKB cwi YwZ nḫe | cieZḫavḫc GB Abgḫv hvPvB Kivi cvj v | agḫ'k³, i³ BZ'w' ms-ḫ. kā cvwḫj tZ aḫḫ kĒ, iĒ nḫj mvariY wḫxvḫšĀ wḫK fvlvZvMĒK mḫ (Linguistic Law) wḫḫmḫe MpxZ nḫe | Gfḫte fvlveĀvbx wḫkḫ t_ḫK mvariY wḫqḫg DcbxZ nq |

fvlv wēĀvḫ nj wēĀvḫbi Ab'vb'' kvLvi gZB AMḫnigvḫ | wēĀvḫbi Ab'vb'' kvLvi gḫZvB fvlveĀvḫ μgvMZ bZb Z_ Avie'vi KiḫQ Ges bZb Z_ i Avḫj vḫK cḫḫbv wḫxvḫšĀ l wḫqḫgi cwi gvRḫ KiḫQ | fvlvi Āvḫ Avḫvnx- Abgḫvix | KviY Zv KZK, wj wḫkḫ l ḫ'vḫšĀK chḫeḫY Kḫi Zv t_ḫK GKwU mvariY mḫ Avie'vi Kḫi | G mvariY mḫ, t̄jv fvlvi wēfbaDcv'vb wḫḫmḫe aḫvb, kā, evK' BZ'w' wḫKfḫte mḫ nq, wḫKfḫte KvR Kḫi Zv e'vL'v Kḫi | fvlveĀvḫbi wḫRĀvḫv wḫkḫ l ḫ'vḫšĀ t_ḫK i iḫnq Ges Zv mvariY mḫ i wḫK GwMḫq hvq |

fvlveĀvḫbi AvḫjvP'' wēlq

fvlvi GK GKwU AskḫK AvḫjvP'' wēlq iḫc MḫY Kḫi fvlveĀvḫbi c_zK c_zK wēfvlM Mḫo DḫvḫQ | fvlvḫK wḫkḫY Kiḫj Avgiv Zvi bvbv ḫ'li cvB Ges bvbv ḫ'li bvbv Dcv'vb cvB | Avgiv cōḫgB t̄'wL th, Avgivḫ' i fvlv KZK, t̄jv evḫK' i mgwō | evK'cēvḫḫK wḫkḫY KiḫZ wḫtq cōḫg th GK GKwU A_ eYḫGKK (Unit) cvB Zv nj evK' | GB evK'ḫK Avevi ḫḫzZi Astk wḫkḫY Kiḫj Avgiv KZK, t̄jv kā cvB | Avevi kāḫKI ḫḫzZi Astk wēwó Kḫi KZK, wj aḫvb ḫcḫq hvB | aḫvbḫK Avgiv Avi Zviḫtq tKvḫv ḫḫzZi Dcv'vḫb fvlM KiḫZ cwi bḫ | fvlv wēĀvbxiv Aek'' cōZ'KwU aḫvbḫK KZK, wj aḫvb wēwó' i (Features) mgwō eḫj _vḫKb, wḫKŠ' mvariYZ GZ m² wḫkḫY Kiv nq bv | tgvUvḫvḫfḫte aḫi wḫtZ cwi th, fvlv wḫkḫḫYi tkl avc nj aḫvb, GB aḫvb nj fvlvi ḫḫzZg Dcv'vb, Zvi gj- Dcv'vb | aḫvb nḫ'Q fvlvi cōḫg ḫ'li | Zvi cḫi KḫqKwU aḫvb mḫvḫtq (A_ ev KLḫv KLḫv GKwU gvĀ aḫvbḫZB) fvlvi th A_ eYḫḫḫzZg GKK cvB ZvḫK Avgiv ewj kā (Word), wḫKŠ' fvlveĀvḫbi cwi fvlvq ZvḫK kā bv eḫj iḫcgj- ejv nq | aḫvb i cḫi ḫ'li

i/cgj- i`li| Gi ctii`ti Avgiv t`l KZK_vij i/cgj- Ges kã vtj GK GKIU evK`
(Sentence) MVZ nq| mvariYZ GB`li chSB fvlv vevÁvtb fvlv m`útKÁvtj vPbv nq|
Gi ctii`ti KtqKIU evK` vbtq GK GKIU Abj`Q` i vPZ nq, KveZv ntj`ék|
AfbK_v tjv Abj`Q` ev`ék vbtq GKIU e³Zv ev m`vnZ`Kg`Mto I`v| Gme m`oi
v`kY I MVbfw`/2 evL`v vbtq mvariYZ e³ZveÁvb, Ajskvi kv`;
(Rhetoric) c`vZ`
`Zš; kv`; Mto D`v`Q| fvlv vevÁvtbi t`jT` μgk c`hvi Z nt`Q| Avaj`K Kvtj
`kj vevÁvb (Stylistics) vrtg fvl vevÁvtbi th bZb kvLviU Mto D`v`Q Zv`Z Gme vel q
Avtj vPZ nt`Q| Zv Qvov Q`v` vevÁvb (Prosody) fvl vevÁvtbi A½ vntmte AfbK AvMB
c`Z`v jvf Kti`Q|

fvlvi vZbiU c`vb`li nt`Q avnb, i/cgj- Ges evK`| G vZbiU vevÁvtbi c`vij Z vrg nt`Q
h`vμtg avnbZ`E; (Phonology), i/cgj-Z`E; (Morphology) Ges evK`Z`E; (Syntax)|
c`eZ`cvvmg`n Avgiv G vel q_v tjv m`útK vevÁvtbi Z RvbtZ cvie|



cvÁvtvEi gj`vqb: 2.1

A) msv`v`B D`Ei c`kæ

1. fvl vevÁvb vK?
2. fvl vevÁvtbK tKb vevÁvb vntmte AvfviZ Kiv nq, G m`útKÁvtj vPbv mst`j`tc
v`j L`v|
3. fvl vevÁvtbi c`xvZ Avti vnx bviK Aeti vnx? gtZi c`j` h`v` v`b|
4. fvl vevÁvtbi Avtj vP` vel q vK vK? `kj vevÁvb vK fvl vevÁvtbi Avtj vP` vel q?

cW 2.2

aYnbZĒj

Dt'ik"

GB cW tk'tl Avcib—

- aYnbZĒj wK Zv e'L'v Ki'tZ cvi'teb;
- aYnbgj- wK Zv Av'tj vPbv Ki'tZ cvi'teb Ges
- aYnbgj- wY'q'i c'urqv Rvb'tZ cvi'teb|

aYnbZĒj

fvlvi tgšwj K I q'žZg GKK nj aYnb| fvlweAv'tbi th Astk aYnb m'útk'Av'tj vPbv Kiv nq Zv'tK aYnbZĒj etj | Zte e'vcK A't'c'wLi Kj aYnb, nvZZwvj i kã, evnk i kã t'tK i iæK'ti gvb'tl i KÉ t'tK D'Pwii Z aYnb chš'menKQysound ev aYnb msuk'w | wKš' fvlweAv'tb t'Kej gv'l gvb'tl i evMht'sj m'vnt'h" D'Pwii Z aYnbmgn wbt'qB Av'tj vPbv Kiv nq| gvb'tl i evMht'sj m'vnt'h" D'Pwii Z aYnb'tK Avgiv evMaYnb (Phone) ewj | Avi t'Kvb fvlvh hZ evMaYnb cvl qv hvq Zvi w'w' w'eb'vm m'útk'ZĒj'q cVb-cvVb, m'w'w' w' Av'tK aYnbZĒj ej v hvq|

gvbefvlvi mKj evMaYnbB Av'tc'w'Kf'ite GKB iKg aYnbK 'enk'oi t'QvU t'QvU tmU ōvi v w'et'kw'Z | t'Lv hvq th, c'w'exi GKwU gnv't'k c'w'ij Z mKj fvlv'tZB GKB tk'Yxi wKQy aYnb e'eüZ nt'Q| Avevi c'w'ex R'tjo mKj fvlv'tZB evMaYnbi GKB iKg w'eb'vm KvR K'ti | tmRb'w Avgiv hLb GKUv fvlv w'k'w' t'Kvb&c'Kvi evMaYnb H fvlv'tZ e'eüZ nq Zv t'R'tb w'B|

Dc'ti i Av'tj vPbv t'tK aYnbZĒj' th w'K' t'jv 'úo ntq l'tV Zv nt'Q, aYnbZĒj nj evMaYnb I Zvi aYnb-w'eb'vm m'útk'Z w'el q I Av'b|

- c'w'exi c'w'Z'KwU fvlvi B w'R'w' aYnb-w'eb'vm i'tq'tQ|

aYnb-w'eb'vm ej t'Z Avgiv evš:

- c'w'É/msuk'w fvlvq e'eüZ aYnb mg'tni GKwU tmU,
- k'tã i g'ta" e'eüZ aYnb t'jvi m'w'e" c'wi m'3/4v Ges,
- fvlwK aYnbi e'R'w, m'sthvRb A_ev c'wi eZ'w'bi c'w'urqv|

aYnb-w'eb'vm c'w'v'Z w'Zb'f'v'tM w'ef³ nt'Z cv'ti :

- K. msuk'w aYnb t'jvi Zwvj Kvq Aw'gj v'K'tZ cv'ti,
- L. aYnb t'jv GK GK fvlvq GK GK µg Ab'w'q'x Av'm'tZ cv'ti, Ges
- M. th mKj m'f ev c'w'urqv aYnb'tK/aYnb c'w'w'Z'tK w'bw'w'šZ ev c'w'v'w'Z K'ti Zv w'w'f'bw'nt'Z cv'ti |

añbgj-

gvbtji evMhtšj mrvth` D`PwiZ hZ evMañub ev Phone Avgiv i`btZ cvB Zvt`i me,uj hvezix fvlvq ZvrchEY^Q(Significant) FngKv MñY Kti br| GK GK fvlvq GK GK iKtgi evMañub ZvrchEY^QFngKv MñY Kti| cŰZ`K fvlvi ZvrchEY^Qañub,tjv nj tmB fvlvi gj- añub ev añbgj-, Ab,uj nj tmB me añbgjt iB D`PriY `eipT` (Variation)| thgb evsvq Őkuj Ő ktāi k&l Őkuj Ő ktāi ŐkŐ nj GKUB añbgj- (Phone)| wKš` b ktā mubmZ añubi cřvte ` b ŐkŐ Gi D`PriY wfbŏ Őkuj Ő ktā ŐkŐ Gi m½ Őj Ő hř ntq AvtQ| j &Gi D`PriY `vb nt`Q `šli KvQvKvQ| GB j &Gi cřvte Gi m½ hř k&Gi l D`PriY `vb `šli KvQvKvQ ntq tMtQ| A_v^Ŕ evbvŏ ŐkŐ_vKtj l mvariY evOvij i D`PriY i hvi meix ms`Z.D`PriY AbyriY Kti br Zvt`i D`PriY Őkuj Ő ktāi Zvj e` ŐkŐ KvŏZ D`PwiZ nq `šl ŐmŐ Gi gtZv| GB th ŐmŐ tK fvlveAvtŏ evsvri GKUB `Zšj; añbgj- br etj ŐkŐ GiB weipT` ifc ej tZ cwi | Avevi Őkuj Ő ktāi th ŐkŐ Zvi D`PriY Zvj e` ŐkŐ -B| mživis Avgiv t`L tZ cvB evsvq GKB añbgj- ŐkŐ Gi D`PriY Őkuj Ő ktā `šl ŐmŐ Gi gtZv Ges Őkuj Ő ktā Gi D`PriY Zvj e` ŐkŐ| fvlv veAvtŏi wqŏg gj-añub ŐkŐ tK ejv hvq Phoneme ev añub gj-| Avi mubmZ añub cřveZ Zvi D`PriY MZ weipT` ifc,uj tK ejv nq gj-añubi mñañub| mživis fvlvq Avgiv hZ evMañub i`btZ cvB Zvi KZ,tjv nt`Q añbgj- ev tdmvg Avi KZ,tjv gj-añubi D`PriY `eipT`| G D`PriY `eipT` `ŏj Kg ntZ cvti- GKUB tK etj mñañub (Allophone) Ab`w tK etj gř `eipT` (Free Variation)|

Dctii Avtj vPbv t`tK añbgjt i msAv wbt`R Ki tZ wMtq Avgiv wbtPi `enkŏ,tjv D t j - L Ki tZ cwi :

- añbgj- nt`Q fvlvi ŧžZšj;añubZvEĶ GKK Ges
- añbgjt i GKK ej tZ añbgj-MZ `eci tZ`i cŰZ`K m`m` tK wbt`R Kiv nq|

añbgjt i msAv cieZKvtj Avi l m`uñmvi Z ntqtQ| eZŏvŏb añbgj- ej tZ tevsvq-

tKvb fvlvi ŧžZg GKK, hvi wR`^tKvb A_ŏbB wKš` A_ŏcKvtk mrvth` Kti Ges añubZvEĶ cwi tētk cwi evZŏ nq|

Avgiv D`vni tYi mrvth` G `enkŏ,uj wētkdY Ki tZ cwi :

1. /K/ añub tK añbgj- wntmte wPvY Z Kivi KviY th /K / tK Gi tPtq ŧžZg Astk wēf³ Kiv hvq br| tmŧŧ t` /K/ ŧžZg GKK|
2. /K/ añubi wR`^tKvb A_ŏbB wKš` b`bZg tRvtŏi mrvth` A_MZ w`K Őúŏ Kti | thgb:
 - /Kvj /
 - /Lvj /
 - /Mvj /

G wZbW ktāi tklvsk-Avj GK, wKš` ktāi cŰtg e`eüZ añub,tjv c_wK etj wZbW c_wK A_ŏcKvKZ|

- 3. aᶿbgbtj i cwi eZᶿ aᶿbZvMĚK cwi tētki | ci wbfPkyj | ōaᶿbZvMĚK cwi tēkō A₄_⊙ tKvb aᶿbi AvtM ev cti e"eüZ th tKvb aᶿb tevSvq| thgb ŐPij ZvŌ I ŪcvēvŌ `ᶿU kā| GB Dfq ktā /j/ aᶿb_vKv mtĚj| cŪg ktā /j/ Gi cti `šī aᶿb_vKvq Zvi cKwZMZ tKvb cwi eZᶿ nq w, wKš' wŌZxq ktā /j/ aᶿbi ci gaP" aᶿb_vKvq /j/ aᶿbi cKwZ. cwi eZᶿ nqtqQ| tm Rtb" cŪtg ktāi /j/ aᶿbgbtj, wKš' wŌZxq ktāi /j/ aᶿbgbtj- bq, GwU gj-aᶿbi mnaᶿb ev Allophone| mnaᶿb ej tZ aᶿbZvMĚK cwi tētk aᶿbgbtj i cwi eZᶿ ifctK wbt`R Kti |

aᶿbZvMĚK cwi eZᶿkyj Zv t_tK aᶿbgbtjK c_wK Kiv I tKvb fvlvq tKvb&Dcv`vb aᶿb gj- wntmte wbt`KZ nte Ges tmB mt½ tKvb&Dcv`vb aᶿbZvMĚK cwi eZᶿkyj Zv wntmte MpxZ nte Zv Avgiv mtĪ i mrvvth" Avtj vPbv Ki tZ cwi |

mĪ: 1

hw` KLtbv `ᶿUv aᶿb GKB aᶿbZvMĚK cwi tētk e"eüZ nq Ges A₄_P tKvb cv_R" wbt`R bv Kti hw` GKwU i cwi tZ⊙ Ab"U tK i`e`j Kiv hvq Zvntj Dfq aᶿbi aᶿbZvMĚK cwi eZᶿkyj Zv wntmte MpxZ nte |

aᶿbZvMĚK cwi eZᶿkyj Zv `ᶿU tgšj Av`tkP tcŪtZ wētkd Y Kiv hvq: cŪgZ fvlvi Av`kMZ Kivvqgq tm_wj i m=úK⊙ Ablyvqx| wŌZxqZ tm_wj i wbt`RK wlvq Ablyvqx| thgb:

evsjvq Zvj e" /k/ Ges `šī /m/ e" w³ wētktli D"Pvi tYi tᶿtĪ ÷vBj MZ `ewktō"i Rb" cwi eZᶿkyj Zv jvf Kti |

evsjvq e" w³ wētktli D"Pvi tYi Rb" wRtfi K=úb ev tKvb tᶿtĪ wRf tcŪtbi w K temktq D"Pvi Y Kivq /i/ I /o/ cwi eZᶿkyj Zv jvf Ki tZ cwi |

mĪ: 2

hw` `ᶿU aᶿb GKB aᶿbZvMĚK cwi tētk e"eüZ Ges A₄_P cwi eZᶿ NwU tQ Zvt`i ci`úitK i`e`j Kiv bv hvq, Zvntj Dfq aᶿbi `Zš; aᶿbZvMĚK Dcj wai Rb" tm_wj v `Zš aᶿb wntmte MpxZ nte |

mrvvYZ b`bZg tRvtōi mrvvth" wvfbægtj-aᶿbi `vZš; I A_MZ cv_R" wbt`KZ nq| thgb: evsjvq Zvb, hvb, `vb, avbŌ GB kā_wj tZ GKwU aᶿbi Rb" kāwU cjtjv A_⊙ citē hv"Q, KvrtB GLvbKvi wvfbæ aᶿb /Z, _, d, V/ ktāi gta"Kvi wvfbævtK `ecixZ"i Ōviv wbt`KZ Kiv hvq| GRb" B G_wj evsjv fvlvi `vZš;K aᶿb| cŪZ"K fvlvtZB Ggnb `vZš;K aᶿb_vtK, Avi Gi Kg `vZš;K aᶿb_wj vb ntjv fvlvi tgšj K aᶿb-GKK |

mĵ: 3

hw` kāmZ ev D"PrīřYi w`K t_řK `wĵ m=úwRZ aYnb KLřbv GKB aYnbZwĚK cwi řetřk
e"eüZ bv nq Zvntř Zvř`i GKB aYnbi wĵwř Z cwi eZřkřj Zv wntřte aiv hvq| thgb:
BřřiwR řvřvq wZbıw aYnb (A, a, æ) AvřQ Ges tm_řjv tKej GKıw wěřkl Ae`vq
e"eüZ nq| wKř' GB wZbıw aYnb kãřq I D"PrīYřq w`K t_řK ci`úi m=úwRZ| A_ř
GB wZbıw aYnbi D"PrīY`řb GK|

cieZřcřřV Avřiv iřcgř m=úřKřRřbřZ cřie|



cřřVwĚi ĵř`vqb: 2.2

A) mřwřřB DĚi cřœ

1. aYnbZĚj eř řZ wK tevřSb?
2. aYnbĵř m=úřKřavi Yř mřřřřc e"ř Ki ab|
3. mnaYnb wK?

cW 2.3

ifcgj-ZĒj

Dt'ik"

GB cW tk#l Av#b—

- ifcgj-ZĒj wK e"vL"v Ki#Z cvi#eb;
- kĀ I ifcgj i cv_# " wbt`R Ki#Z cvi#eb;
- ifcgj- kbv³ Ki#Z cvi#eb Ges
- ifcgj i tk#Y wfvM Ki#Z cvi#eb|

Avgiv Av#MB tR#bwQ, fvlvi metPtq tgšw K I ¶žZg GKK nj aYnb| Avi GKwaK aYnb wgwj Z n#q aYnbi tPtq epĒi th GK GKwU A_#Y#GKK Mto tZvtj Zv nj kĀ (Word)| ktĀi wewfbæw`K thgb- Mvb, tk#Y wfvM, ifc`ewPĪ" mva#bi wewfbæDcKiY (cZ"q, wfv³) nj ifcgj-ZĒj Av#j vP" welq|

ifcZĒj cĀ_wgK cwip#qi Rb" Avgiv etj _wK, aYnbi tPtq epĒi GKK nj kĀ (Word) Ges tguUvgw#f#te ktĀi wewfbæw`KB ifcZĒj Av#j wPZ welq, ZeyAvan#K fvlweÁvbxiv etj _v#Kb, aYnbi wK cieZ#epĒi GKwU kĀ bq, tmUv nj ifcgj- ev Morpheme|

ifcgj-

ifcgj- Kv#K etj Ges ktĀi m#_ ifcgj i cv_# " Kx Zv Rvbx `iKvi | G cĀ#½ wewfbæ fvlweÁvbxiv wewfbæv#te msÁv w`tq#Qb, thgb- fvlweÁvbx bx`v etj #Qb- Minimum Meaningful Unit- B nj ifcgj-| wKš' fvlv weÁvbx e- gw#dĪ Zwi msÁvq etj b- A linguistic form, which bears no partial phonetic semantic resemblance to any other form is a simple form or morpheme. Zte meir K wgwj #q Avgiv ej #Z cwii th, ifcgj- (Morpheme) nj GK ev GKwaK tdnvbtgi mgš#q MwZ Ggb A_#Y# ¶žZg GKK hv tcšYtcw#K Ges hvi Ask w#k#l i m#½ Ab" ktĀi aYnbMZ I A_#Z miv`k" tbB| Avi tKvb aYnb ev aYnb mgw#tK ifcgj- n#Z n#j Zv#K PwU kZ#c#Y K#Z n#e:

- GK ev GKwaK aYnbi mgš#q MwZ ¶žZg GKK n#Z n#e|
- H GKwU i GKwU A_#vK#Z n#e|
- GB GKwU#K fvlvi g#ā" evi evi w#tĪ Avm#Z n#e|
- GKwU i Ask w#k#l i m#½ Ab" GK#Ki aYnbMZ I A_#Z wj _vK#e bv|

tKvb aYnb ev aYnb mgw# Dc#i i PwU kZB hv` ci-Y K#i Z#eB Zv#K ifcgj- etj | wKš' tKvb aYnbmgw#tK kĀ (Word) n#Z n#j me#v Dch# PwU kZB ci-Y bv Ki#j I P#j | A_#, kĀ nj Ggb aYnb mgw# hv A_#Y# tcšbtcw#K, wKš' Zv ¶žZg GKK bv| n#Z c#i |

evsj vq ŐAvgŀ GB aYmbgwiŀ nŀ“Q Ggb GKiu A_eyGKK hvŀK Avi ʃžZg A_eyGKŀK fivM Kiv hvq bv| hvŀ tRvi Kti fivM Kiv nq (thgb Av-g) Zvntj Gi th`uj Ask cvl qv hvŀ, Zvi tKivbiUi tKivb gvŀb nŀe bv| AZGe ŐAvŀ ev Őgŀ `Zšfivŀe tKivb ifcgj-bq, uKš' ŐAvgŀ GKiu ifcgj-| Avevi AvgmĚj GKiu gvŀ ifcgj- bq| GLvŀb `uj GKK AvŀQ Ges `uj iB `Zš;A_eyAvŀQ| AZGe ŐAvgŀ I ŐmĚĴ`uj ifcgj-| uKš' ktāi tejvq ŐAvgmĚĴ GKiu kā| A_ey Avgiv ej tZ cwi kā KLŀbv GKiu gvŀ ifcgj- vŀtq MvZ nq, Avevi KLŀbv GKivaK ifcgj- vŀtq| MvZ nq|

ifcgj- mbv³KiY

tKivb fivM ifcgj- mbv³KiYi cŀg avc nj tmB fivM ev eüZ ev`e iŀci bgŀv Zžj Gŀb chŀeŀY Kiv| G veltq fivM veAvb bx`v KŀqKiu mŀ ev Dcvq etj tQb| fivM veAvb bx`vi cŀg mŀ Abjviti fivM t_ŀK msMpxZ Dcv vŀbi `uj aYmb mgwiŀ gŀa` hv aYmbMZ I A_MZ mŀ`k` _vŀK Zŀe Zvŀ`i GKiu ifcgj- etj vŀpŀyZ Kiv hvq| thgb- ŐAvZvŀ, Ő`vZvŀ, ŐKZŀ, ktā Zv e`eüZ nŀtqQ| GB vZbv kŀāi Zžbv Kti tevSv hvq vZb- ŐZvŀ Gi A_eymüófvŀe GK| KvY, vZbv tŀtŀB Gŀt vŀqvŀ KZŀK tevSvŀv nŀtqQ: AvZv- th Rvŀb, `vZv- th `vb Kti, KZŀ th KvR Kti| GB vZbv vŀqvŀ A_eyc_vK| uKš' ŐZvŀ Gi Ővŀ vZbv tŀtŀB KZŀZi th tev tRŀMŀQ tmB KZŀZi tevŀa mŀ`k` AvŀQ| GUv A_MZ mŀ`k`| Avi vZbv ktāi ŐZvŀ Astki gŀa` aYmbMZ Avfŀv tZv t`LvB hvŀ“Q| mživs ŐZvŀ nj GKiu ifcgj-| tZgub BŀtiR Doing, Running, Working ktā th vZbv `ing` AvŀQ Gŀ`i gŀa` A_MZ I aYmbMZ mŀ`k`; mživs `ing` nj BŀtiR tZ GKiu ifcgj-|

uKš' hvŀ GKivaK iŀci gŀa` i aYaYmbMZ mŀ`k` _vŀK Ges A_MZ mŀ`k` bv _vŀK Zv nŀj Zviv GKB ifcgj- bq| thgb- ŐAvZvŀ, Ő`vZvŀ, Őj Zvŀ ktāi vZbv ŐZvŀ Gi gŀa` aYmbMZ mŀ`k` AvŀQ, Zŀe Gŀ`i A_MZ ZvrchGK bq| mživs ŐZvŀ GLvŀb GKiu ifcgj- bq| GKBfvŀe BŀtiR Darkling, Sing I Spring ktāi vZbv- `ing` Gi gŀa` aYmbMZ mŀ`k` AvŀQ, uKš' A_MZ tKivb müó mŀ`k` tbb| AZGe, `ing` GLvŀb tKivb ifcgj- bq|

bx`vi ŐZvq mŀ Abjvqx Avgiv ej tZ cwi, th me aYmb msMvŀbi gŀa` müó A_MZ mŀ`k` AvŀQ, uKš' Zŀe uKwĀZ aYmbMZ cv`ŀ I AvŀQ tm me aYmb msMvŀb| GKB ifcgj- aiv nŀe| thgb: evsj v fivM- Őmšymŀ, ŐmüYŀ I ŐmŀvPbŀ ktā GKuv A_MZ vj AvŀQ, tmB vj Uv cwi cYZvi vj | Őmšymŀ, ktā tevSvŀ“Q GKuzŀvm bq e`vcK ŀvm, tZgub ŐmüYŀ ktā tKivb i Kŀg cYŀtevSvŀ“Q bv, tevSvŀ“Q GŀKevŀi cYŀ tZgub Avevi ŐmŀvPbŀ ktā GKuzKĀb bq, müYŀKĀb tevSvŀ“Q| uKš' mgm`v nj GB Őmbŀ, Őmgŀ I mŀGgi gŀa` A_MZ vj _vKŀj I aYmbMZ vj cŀjvcŀj tbb| GLvŀb cv`ŀ nŀ“Q Őbŀ, Őgŀ Ges Őŀŀ aYmbŀZ| Zŀe GKuzZvj t`Lŀj eŀtZ Kó nŀe bv th G_vj v gŀj GKB aYmb vj - gŀj iŀcu vj Őmgŀ| GB vZbv aYmb nj (mb& mg& mŀ) GKB ifcgj i Dciŀc (Allomorph)|

bx`vi ZZvq mŀvjbvqx ejv hvq, th me aYmb msMvŀbi gŀa` cvŀ`üvi K A_MZ mŀ`k` AvŀQ A_P tdivgMZ `emv`k` iŀtqQ Ges tmUv aYmb cwi eZŀbi mŀ Ővŀ e`vL`v Kti Zvŀ`i gŀa` AšbŀZ gŀj xŀZ mŀ`k` t`Lvŀv hvq bv, Zviv GKB ifcgj- nŀZ cvŀi | hvŀ t`Lv hvq th Zviv cwi cK Ae`vŀb (Complimentary Distribution) iŀtqQ, A_ey

ᚦ Ae GW#Kkb

GKwUj ᚦvb AbwU emtZ cwti bv| thgb: evsjvq tKwKjv, mwakv, gqix, iæŷYx
kã, wj tZ šwjj ½ cŁ`q h_vµtg- Av, BKv, C, Avbx| Gt`i gta` tdmvbgMZ mw`k` tbB|
ZeyGiv GKB ifcgj-| KviY, Giv GKB A_`enb Kti ᚦevPK A_`

G_s,tjv nj ifcgj- mbv³ Kivi cāvb KtqKwU mĤ I c×wZ| Zte ifcgj- wbyŷqi GB me
weia weavb Rvbvi mĤ½ mĤ½ Avtiv wKQyK_v AvgvĤ`i gtb ivLĤZ nte| cŁgZ Avgiv th
fvlvi Dcv`vb t_ĤK ifcgj- wbyŷ Kwi, wbyYxZ ifcgj- wj tmB weĤkl fvlviB m`u` | A_ŷ
meŷwll K ifcgj- etj wKQytbB|

wŁZxqZ ifcgj- nj fvlvi mvgwll MVĤbi GKwU A½| fvlvĤ`tn cŁZ`K AĤ½i web`vĤmi
wBR`^`vb I iwxZ AvtQ| tKvb tKvb fvlvi MVĤb cŁZ`K ifcgj- i e`envti i `vb wbyŷ|
fvlvi MVĤb GKwU ifcgj- ev Zvi Dciŷc th th ᚦvb etm tmB tmB `vbĤK eYŷvgj-K fvlv
weAvĤb tmB ifcgj- i Ae`vb (Distribution) etj |

ifcgj i tkŷweŷwll

ifcgj- ŷaitbi ntZ cwti-

- gŷ ev `^Q` ifcgj- (Free Morpheme)
- ex ifcgj- (Bound Morpheme)

gŷ ifcgj-

th A_`eY`ŷjzZg aŷwbgwó fvlvq Ab` aŷwbgwó mĤ½ m`u`Kŷŷ bv ntq| ᚦaxbfite
e`eüZ ntZ cwti, ZvĤK gŷ ifcgj- etj | thgb- ŰAvg AvgvĤ`i wĤŷ dj Ű| GLvĤb ŰAvgŰ
nj gŷ ifcgj-|

ex ifcgj-

th A_`eY`ŷjzZg aŷwbgwó me`v Ab` aŷwbgwó mĤ½ hŷ ntq e`eüZ nq, KLtbv
ᚦaxbfite e`eüZ ntZ cwti bv, ZvĤK ex ifcgj- etj | thgb- Űmŷ` Avtgi im Avgvi
wĤŷ Lvevi Ű| GLvĤb Avtgi ktāi- ŰGiŰ weŷw³w ex ifcgj-| ŰGB tQtj wU fwi wgwóŰ Ges
H tQtj Uv eLvĤUŰ- GB `ŷw evĤK` wU I Uv nj ex ifcgj-| ŰtQtj wU ej tj Av`ti i fve
Ges ŰtQtj Uv ej tj GKUv NYvi ev ZvwQtj`i fve dŷV DĤV|

ifcgj-ZĖ; cŰPxb I AvaybK Dfquea fvlweAvĤbiB GKwU mg× Ask| ktāi MVb I
ifc%wPĤ`B GB ifcgj-ZĖ; cāvb Avtj vP` wclq|



cv#V#i gj`iqb: 2.3

A) iPbvj-K ckae

1. ifcgj- #K? ifcgj- I kta`i gta` cv_#` #K?
2. ifcgj- MV#bi kZ#tj v D#j # Kiab|
3. Pvj, Wvj, nvj G k#mg#ni gta` tKvb ifcgj-MZ mv`k` Av#Q #K? Avcbvi gZvg#Zi c#q| h#p# v` b|
4. Dcifcgj- #K?
5. ex I g# ifcgj- ej #Z Av#vb #K tev#Sb?

cw 2.4

evK"ZĒj

Df'k"

GB cw tkfI AvciB—

- evK" I evK"ZĒj m#útk#ej tZ cvi teb;
- fvl meÁvfb evK"tk me#kd tYi meva I `wófwi½ e"vL"v Ki tZ cvi teb;
- Hwzn"mZ e"vKi tYi evK"ZĒj m#útk#ej tZ cvi teb Ges
- eYb#j-K I mvsMvibK fvl meÁvfb i evK" me#kd Y c#wZ m#útk#ej tZ cvi teb |

evK"ZĒj

Bstirx Syntax ktāi cĀZkā inmvte evsjvq Avgiv ūevK"ZĒj K_wU e"envi Kti _wK |
BstirxZ GB Syntax kāwU G#m#Q MĀK Syntaxis t_#K | MĀK fvlvq GB kāwU cĀg
cĀqum Ktib MĀK `eqvKi wYK w I byni m#_# (Dionusius Thrax) | MĀK fvlvq kāwU
A_#GKĪ meb"vmŌ | GB t_#K evK" gta" kā mg#ni GKĪ meb"v#mi ZĒj A_#t#g Syntax
K_wU c#vj Z nq |

Syntax th#nZzevtK"i ZĒj tm#nZzevK"ZtĒj Avtj vPvri cĀt#gB Avgt`i tRtb tbl qv
`i Kvi evK" ej tZ wK tevSvq? m#wZK#vi P#Evra"vq Gf#te evK"i msAv w tqtQb,
Ōth c` ev kā mgwŌi Ōviv tKvbl me#tq m#úY#f#c e#vi fve cĀw#Z nq, tmB c` ev
kā mgwŌtk evK" (Sentence) etj Ō | wZvb Avi I `úo Kti etj tQb, ŌtKvbl fvlvq th
Dw#i mv_#Zv Av#Q, Ges MV#bi w K t_#K hv `qsm#úY#m i Kg GKK Dw#tk e"vKi tY
evK" etj Ō |

fvlv#K me#kd Y Ki t#j cĀt#g th epĒg GKK Avgiv cvB Zv nj evK" Ges evK"i gta"
tKv#k#kā tKv_vq emte I Zv`i gta" cvi `wmi K m#úK#K i Kg nte Zv fvl meÁvfb i th
kvLvq Avtj wPZ nq, Zv#K evK"ZĒj (Syntax) etj |

fvl meÁvfb evK"tk me#kd tYi mevfbe`wófwi½ itqtQ | thgb— Hwzn"mZ evsjv e"vKi Y,
eY#vj-K I mvsMvibK (Descriptive and Structural), ifvšlġj-K m#okj
(Transformational Generative Grammar) e"vKi tYi `wófwi½ |

**Hwzn"mZ e"vKi tY
evK"ZĒj**

Hwzn"mZ e"vKi tY evK"tk cĀgZ `wU Astk fvm Kiv n#t#Q h_v- Df'k" (Subject) I
me#aq (Predicate) |

Df'k" I me#aq#K t#šj K Dcv`vb inmvte wY# Kti evK"tk wZbU tk#YtZ fvm Kiv nq:

- (1) mij evK" (Simple Sentence),
- (2) w#gk# ev R#Uj evK" (Complex Sentence) I
- (3) thšwK evK" (Compound Sentence) |

th evřK` GKıU gvĪ Dřik` Ges GKıU gvĪ meřaq _vřK Zv-B nj mij evK`| thgb-
ŰKıcj cořQŰ|

th evřK` GKıU cāvB DcevK` _vřK Ges GK ev GKıaK AcāvB ev AvıKZ DcevK` _vřK
ZvřK ıgk^aev RıUj evK` etj | thgb- Űth gvbjıv RıebřK fıj evmřZb, ZııvB Rıebı
c_ iPbv Kıtř tctıřQbŰ| GB evřK` Űth gvbjıv RıebřK fıj evmřZbŰ nj AvıKZ ev
Aaxb DcevK` Avi ŰZııvB Rıebı c_ iPbv Kıtř tctıřQbŰ nj cāvB DcevK`|

th evK` GřKi tekx cāvB DcevK` mřhvřM MıvZ nq ZvřK thřMıK ev mřřř evK`
(Compound Sentence) etj |

GřKi tekx mij ev ıgk^aevK`řK mřhvřRK Ae`q (Ges, I, Avi cřıvZ) ev meřqvřK Ae`q
(A_ev, ev, ıKsev) ıř`řq hřř Křı th evK` MıvZ nq ZvřK thřMıK ev mřřř evK` etj |

thgb- ŰKıcj tj Lvı cořq fıj Ges ř`řki ivR%ıvZK A_ııvZK Ae`v mřřřřKř mřPZbŰ|

GLıřb `ŰU mij evK`řK GKıU mřhvřRK Ae`q (Ges) ıř`řq thřM Kıv nřřřQ|

**eYřvgj-K fılv
ıeÁřb evK`ZĚj**

eYřvgj-K fılvıeÁřb evK`řK fılvı epĚg GKK (Unit) ařı ZvřK ařc ařc ıgk
epĚı ř`řK řřřZı Dcv`řb meřkřY Kıv nq| evřK`ı GB meřkřřY cŰřgB KZK_ıj gj-
avıYv mřřřřK^oAvřřř`ı mřřřř Ávb _vKv`ıKıv| GıKřgi GKıU gj- avıYv nj Mvb
(Construction)| LıřZ ev cřA_řıgıřZ th řKıv c` mgıřřK ev řcgj- mgıřřK Mvb
ejv nq| thgb ŰKıcj hLb KıřRı GKřNřřřřřZ megl`ZLb fıj evmıv mRıe cik Gřb
ıř` mřřřZıŰ| GB mgMŰc`mgıřı gřa` GKıU mřřřřKř eŰb AvřQ Ges Gı GKıU cřřř
A_`AvřQ, GıU GKıU evK`| GB mgMŰevK`ıU nj Mvb| Avevı ŰKıcj hLb KıřRı
GKřNřřřřřZ megl` GB c`mgıřı A_`cřřřř bq; ıKř` GıI GKıv A_`AvřQ hıř I Zv
LıřZ Ges Gı c`_ıjı gřa`ı cvı`ıııK mřřřřK^oAvřřQ| GB c`mgıřı Mvb| Gı řřřř
řřř`c`mgıřı nj ŰKıřRı GKřNřřřřřZŰ| GıI ıKŰyA_`AvřřQ, hıř I Zv Avřřř LıřZ| GB
ıKg c`mgıřřK Avřřř c`_`Q (Phrase) evj | GB ıKg c`_`QřKı Mvb etj | mřřřıv
fılvıeÁřb Mvb K_ıU LřB e`vcK A_`enb Křı| GKıaK kã ev řcgj- ıbřř hLbB
řKıřřv LıřZ ev cřA_`řřř GKK (Unit) Mřř Dřř ZLbB ZvřK Mvb etj | GKıU gvĪ kã
ev řcgj-řK Mvb etj bv| Mvb nj- Ař`P mřřřřřř GKıaK kã ev řcgjı mgıřı|
Avevı GKıaK kã GKmřřř ıbřřB Zvř`ı Mvb etj bv| ř`LřZ nře Zvř`ı gřa` A_`řř
mřřřř ev NıbŰZv AvřřQ ıKıv| Dctıı evK` ř`řK `ŰU kã ıbjıv- GKřNřřřřř I Kıcj,
Gıv Mvb bq, KıvY kã `ŰUı gřa` řKıřřv cvı`ıııK mřřřřK^ořb| ıKř` ŰKıřRı
GKřNřřřřřZŰ nj GKıU Mvb| KıvY, Gř`ı gřa` cvı`ıııK mřřřřK^oAvřřQ|

eYřvgj-K fılvıeÁřb evK`řK ařc ařc epĚı ř`řK řřřZı Dcv`řb fıvM Kıv nq| th
řKıřřv MvbřK cŰg ařc Avřřř th KŰU epĚg A_`eřřDcv`řb fıvM Kıtř cıvı Zvř`ı
ŰAe`emřZ MvbMıZ Dcv`řbŰ (Immediate Constituent) etj | thgb- ŰKıřRı
GKřNřřřřřZ Kıcj hLb megl`ZLb fıj evmıv mRıe cik Gřb ıř` mřřřZıŰ- GB
evK`ıUřK meřkřřY Kıtř řMřj GřK Avřřř cŰg ařc meřřřř eo th `ŰU Ařřř fıvM
BĐıvB- 2 ıkřřř thřMřřřř I cřıřřř 32

ᶿ Ae GW#Kkb

Ki#Z cwi Zv nj - (1) 0Kv#Ri GK#Ntqig#Z Kucj hLb megl# Ges (2) 0ZLb fij eimvi mRxe cik Gtb w j m#PZv | H evK"iU#K Gi tP#q eo Dcv`v#b Avi fivM Kiv hvq bv | GB ep#Eg Dcv`vb `#U nj mgM0evK"iUi Ae`einZ MVbMZ Dcv`vb | Avevi hw` iay0Kv#Ri GK#Ntqig#Z Kucj hLb megl# GB DcevK"iU Av#iv me#k#Y Ki#Z hvB Zvntj G#K `#U ep#Eg Dcv`v#b fivM Ki#Z cwi - (1) Kucj Ges (2) hLb Kv#Ri GK#Ntqig#Z megl# GLv#b GB `#U nj DcevK"iUi Ae`einZ MVbMZ Dcv`vb | Avevi hw` 0hLb Kv#Ri GK#Ntqig#Z megl# GB AskUKB me#k#Y Kwi Zvntj G#K `#U ep#Eg Dcv`v#b fivM Ki#Z cwi - (1) 0hLb Kv#Ri GK#Ntqig#Z Ges (2) 0megl# GLv#b GB `#U nj 0hLb Kv#Ri GK#Ntqig#Z megl# Ae`einZ MVbMZ Dcv`vb | #KŠ` gtb ivL#Z n#e 0hLb Kv#Ri GK#Ntqig#Z ev 0megl# mgM0evK"iUi MVbMZ Dcv`vb n#j | GuU mgM0 evK"iUi Ae`einZ MVbMZ Dcv`vb bq | 0Ae`einZ MVbMZ Dcv`vb 0 K_v#U A_ Av#iv #K | th MVbU me#k#Y Kiv nq Zvi ep#Eg Dcv`vb#K iayZviB Ae`einZ MVbMZ Dcv`vb etj ; Zvi tP#q ep#Ei MV#bi Ae`einZ Dcv`vb bq | c#e# mgM0evK"iU#K Avgiv #P#i i mrv#h" av#c av#c Ae`einZ MVbMZ Dcv`vb me#k#Y K#i Dc`w#Z Ki#Z cwi |

Kucj hLb Kv#Ri GK#Ntqig#Z megl# ZLb fij eimvi mRxe cik Gtb w j m#PZv								
Kucj hLb Kv#Ri GK#Ntqig#Z megl#				ZLb fij eimvi mRxe cik Gtb w j m#PZv				
Kucj	hLb Kv#Ri GK#Ntqig#Z megl#			ZLb fij eimvi mRxe cik Gtb w j				m#PZv
	hLb	Kv#Ri GK#Ntqig#Z megl#		ZLb	fij eimvi mRxe cik Gtb w j			
		Kv#Ri GK#Ntqig#Z megl#			fij eimvi mRxe cik		Gtb w j	
		Kv#Ri	GK#Ntqig#Z		fij eimvi	mRxe cik	Gtb w j	
						mRxe cik		

#P# 2-4.1: evK" me#k#Y |

Gf#e evK"iK ep#Ei t_#K av#c av#c #j#Zi MVbMZ Dcv`vb me#k#Y Kivi dtj tkl av#c Avgiv th me k# cvB Zv`i evK"i Pig MVbMZ Dcv`vb etj | GB th Pig MVbMZ Dcv`vb k# | tmB k# ch# me#k#Y Kiv evK" Z#Ej Av#j vP" mel#qi g#a` cto |

˘z Ae GW#Kkb

gbbKiY ej tZ tevSv̄bv nq Ggb GKwU ˘enkó˘tK, hv fvlv̄tK ˘˘wbK Avj v̄tci fvlv t_#K weÁvb PP# fvlvq cwiYZ Kivi kw³ t`q|

cij Mviwfb I tg#Wwj b g`w_AU gvb fvlvi Pvi iKg figKv ıbt`R Ktib:

1. msnwZ mvaK
2. ˘vZšj ıbt`RK
3. gh#v ÁvcK I
4. Av`k#fc ıbt`RK figKv|

msnwZ mvaK: GK, "Q Dcfvlv GjvKv̄tK GKwU gvb fvlv GjvKvq msnZ KivB fvlvi msnwZ mvaK figKv|

˘vZšj ıbt`RK: c#Ztckx fvlv mgv̄tRi mıt_ ıbt`Ri mgv̄tRi ˘vZšj ıbt`RB ˘vZšj ıbt`RK figKv|

gh#v ÁvcK: gvb fvlv Zvi fvlv̄t`i gh#v Gtb t`q, c#Zw#Z Kti t`q kw³ gıbt`i gta", GıU nt"Q Zvi gh#v ÁvcK figKv|

Av`k#fc ıbt`RK figKv: gvb fvlvi Av`k#fc ıbt`RK figKv Zvi i×Zvi gıbi#fc ıbt`R Kti |

cij Mviwfb I tg#Wwj b g`w_AU fvlvi gvb AR#bi gv̄v ıby#qi Rb" wZb iKtgi gvb`Đ ıba#Y Kti tQb-

1. gvb fvlvi Avšli ev mnRvZ ˘enkó˘|
2. we#kl fvlv mgv̄tR gvb fvlvi figKv|
3. gvb fvlv m#ú#K#fvlv mgv̄tRi g#bvfve|

Dcfvlv ev AvÁvj K fvlv

mvari Yfıte Dcfvlv ev AvÁvj K fvlv ej tZ tevSv̄bv nq t`tki weıfba#jz"AA#j e"eüZ fvlv̄tK| 0Dcfvlv# k#ıU M#K 0Wıqvtj ±0 kt#i BstıwR t_#K Abgv` | dvi, mb (1960) Dcfvlvi msÁv w`tqtQb Gfıte,

0Dcfvlv nt"Q tKvb fvlvi GK ev GKw#K ˘enP#T`i, "Q, th, tj v̄tZ we`gıv v̄tK GKwU ev GK, "Q mvari Y ˘enkó˘", hv Zıv`i ˘Zšj Kti t`q fvlvi Abvb" ˘enP#T`i t_#K Ges GB ˘enkó˘, tj v̄tK fıvı K ev Afıvı K t#t#T e"envi Kiv hvq GKK i#c|00

A_# Dcfvlv ev AvÁvj K fvlv nt"Q tKvb e"ıck fvlv AA#j e"eüZ fvlv, th, tj vi gta" we`gıv v̄tK bıvı cv_#", wKŠ' Zı ci ˘úi tevaMg"|

**neifbaGj vKvi vKQy
AvĀij K kã**

1867 Aġā XvKv, evLiMĀ, dvi`cj, gqgbwmsn, wmtjU I KvQvi tRjvi ŪBwZnvm I cwi msL`vbŌ c_K c_Kfvġte, miKwi Dġ`vġM cĶvġKZ nq (mZw`ġgnb 1970, 223-227)| G me cwi msL`vġb msKwġ Z nq vKQyAvĀij K kã, XvKv tRjvi msKwġ Z kġāi ġġā AvġQ ŪwfiUŌ (DBzRvqMv), ġgiv (ġl), I iv (Sv), evLiMġĀi kã- ŪtU½v (tZĶĶ), `vDi (Kv), tġvġ (tġġ), gqgbwmsn tRjvi kã A½v (Īqb), UvBj (Sv), wmtjU tRjvi kã- Dev (`wġbv), tNvj vB (gvQ tġvġi cvĪ), KvQvi tRjvi kã- Kvw` (DBz Rvq), `viæ (Kv), dvi (eb`c_)|

gvb fvlv I AvĀij K fvlvi cv_R`:

gvb fvlv	AvĀij K fvlv
(1) tKvb RvwZ ev ivġŌġ mg` fvlv K (ġġLi fvlv I tġLv m=ūvKĶ) `vqZġ; cvj b KiġZ gvb fvlvi cĶj b Acwi nvhġ	(1) neifbaĀĀġġi RbMġYi fve wvbgġġi ġġ`vqZġU cvj b Kġi tm me ĀĀġġi AvĀij K fvlv
(2) gvb fvlv nġ`Q GKvU mġsnZ wvæx fvlv K ifc	(2) AvĀij K fvlv vġ`R Kġi GKvU AvĶz fvlv ifc
(3) gvb fvlv ġhĶv ĀvcK	(3) AvĀij K fvlv gvb fvlvi tĶġ vKQv vbgæġ Kg ġhĶv m=ūbĶ
(4) tġLvq Ges ejvq Dfġ tĶĶĪB GB fvlv i`xZvi vbgvġKiĶc e`eüZ nq	(4) AvĀij K fvlv nġ`Q neifbaDc-fvlvġ`i cvġ`ūvi K thvMġthvġMi K` ifc



cvĶvĒi ġĶ`vqb: 3.1

A) eū vbeĶbx cĶæ

mivK DĒi vġ`RġĶ-K AĶġi vĶĶ eĶvqZ Kiab| Avcbvi vbeĶPZ DĒi vK nġĶ (K) eĶvqZ Kiab:

- 1| gvb fvlvi `enĶŌ` tKvbvU?

(K) AvĶvĶZ	(L) mġsnZ
(M) AvĶv`Ī	(N) Kg gvb m=ūbĶ
- 2| Wvqġġ ± kãvU tKvb fvlv t_ĶK ĶġmĶQ?

(K) cĶKZ.	(L) di vmx
(M) AvĶvæ	(N) MĶK
- 3| gvb fvlvi Pvi iKg fvgKv vġ`R Kġi b-

(K) cvj Mvi wfb I ġġWvġ b ġ`vU_AU	(L) Wvi DBb I ġġWvġ b
(M) dvi`mb I cvj Mvi wfb	(N) dvi`mb I nġMb
- 4| XvKv tRjvi AvĀij K kã-

(K) tcvġĶ	(L) Kvw`
(M) `viæ	(N) ġgiv

cW 3.2

fvlvi tgšLK I vj vLZ ifc

Dt'ik"

GB cW tk'fI Av'cib-

- fvlvi tgšLK I vj vLZ ifci `enkó", t'jv eYv Ki'Z cvi'teb|
- fvlvi tgšLK I vj vLZ ifc m'ayP'ij Z i'xvZi I Av'Á'ij K fvlvi c'q'vM m'ú'fK e'vL'v w'tZ cvi'teb|
- m'ayl P'ij Z i'xvZi Drcw'É m'ú'fK e'vL'v w'tZ cvi'teb Ges
- m'ayl P'ij Z i'xvZi cv_R" w'bifcY Ki'Z cvi'teb|

fvlvi tgšLK I vj vLZ ifc

A'tbK fvlv AA'tjB weivR K'ti Ggb fvlv K cwi w'vZ thLv'tb t'Kvb fvlvi GKvU ifc ev i'xvZ GKvš'f'vte e'ëüZ nq tj Lvq I m'vnt'Z", Av' Ab" GKvU ifc ev i'xvZ e'ëüZ nq c'Z"v'K R'xet'b K't_v'cK_t'b ev m'v'v'RK thvM'v'th'v'M| Ggb fvlv K cwi w'vZ w'et'k'j tek K'tq'KvU fvlvi D'vni'Ymn e'vL'v K'ti'q'b d'v' mb (1959) Z'vi W'vB't'M'm'q'v'j ev w'i'xvZ Z't'É'j| GKB fvlvi `v' i'xvZ e'ëv't'i i g'tj KvR Ki'Z c'v'ti w'v'f'b'e'K'v'i'Y, GB Kv'i'Y, t'jv w'et'k'l fvlv-AA'j I fvlv w'b'f'P| w'i'xvZi D'c'w'v'Z j '7" Kiv hvq Av'ie, M'Á'K, m'ß'm, R'v'g'f'b fvlvq Ges m'v'v'e'x'ifc ersj v fvlvq|

fvlvq e'ëüZ `B'vU ifc n't"Q:

- (1) tgšLK ev K_v'ifc
- (2) vj vLZ ev t'j L'ifc|

ersj v fvlvi tgšj `enkó" g't'Li K_v't'ZB Av't'Q| g'v'b'ly G't'K Act'i i m't'½ K_v et'j , Av'j v'c K'ti ev e'³Z'v w'e'Z'K'K'ti| Av'v'i t'U'ij t'd'v't'bi g'v'a't'g `t'i i g'v'b't'li m't'½l ev'K'w'e'v'bg'q K'ti| g't'Li K_v Z'v'v'v'Y'K c'q'v'R'b t'g'U'v'q, G'U'v `v'q'x b'q| Z'v'b g't'Li K_v't'K t'j L'vi g'v'a't'g `v'q'x ifc t'v'v'i R'b" m'v'i D'c't'h'v'M'x GKvU g'v'R'Z ifci c'q'v'R'b g'v'b'ly A'b'f'e K'ti| G D't'i't'k'B fvlvi vj vLZ ifci D'v'e I w'e'K'v'k N't'U| GB t'j L'vi fvlv't'KB w'k' i'f'c m'g'x K'ti GK`v m'w'o.n't'q't'Q m'v'v'v'Z"|

ersj v fvlvi w'v'f'b'e'ifc w'b't'P t'v't'v'v' nj :

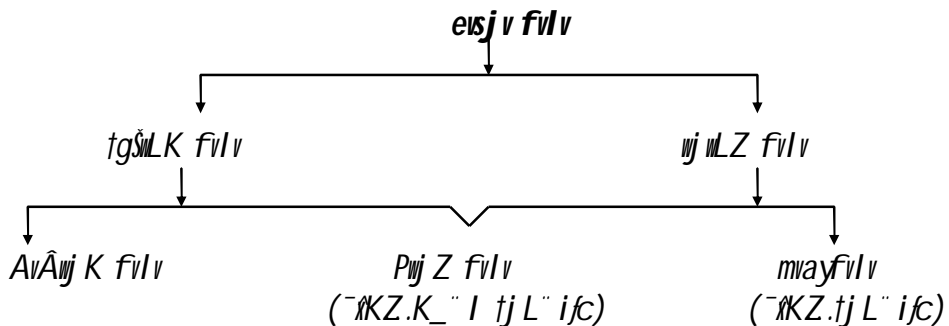

5. G fvlv bvUᄡKi msjvc, Avjvc-AvtjvPbv I e ³ Zv-veZᄡK ^ᄡ Rb ^ᄡ Ly tenk DcᄡhvMx bq	5. G fvlv e ³ Zv veZK ^ᄡ Avjvc-AvtjvPbv I bvUᄡKi msjvᄡci Rb ^ᄡ AᄡcᄡvKZ. tenk DcᄡhvMx
6. mway fvlvq ᄡᄡqv I meᄡvg c ^ᄡ cYᄡᄡc cKᄡᄡZ nq	6. Pᄡj Z fvlvq ᄡᄡqv I meᄡvg cᄡ ⁱ msᄡᄡB ifc e ^ᄡ üZ nq
7. G fvlvq Zrmg kã I mgvm ex cᄡ ⁱ e ^ᄡ envi tenk	7. G fvlvq Z ^m e I ᄡ ^ᄡ kv kᄡãi e ^ᄡ envi tenk
8. Pᄡj Z I Av ^ᄡ ᄡj K fvlv ᄡ ^ᄡ K MᄡᄡZ c ^ᄡ G fvlvq cᄡi nvi Kivi ᄡPóv Kiv nq	8. G fvlv Lᄡᄡ ᄡ ^ᄡ KR ms ^ᄡ vᄡii Avkᄡq Mᄡo DᄡVᄡQ
9. ᄡkᄡL Avq ^ᄡ ᄡi KᄡZ nq eᄡj ᄡPóv Kᄡj mevi cᄡᄡ mwayfvlv ᄡKQᄡᄡ Avq ^ᄡ Kiv m ^ᄡ e	9. Pᄡj Z fvlvi mᄡ ^ᄡ ᄡ ᄡbᄡeo cᄡiPq NᄡᄡZ nq Zv bv nᄡj Gi e ^ᄡ envᄡi ᄡZᄡZ ^ᄡ fve Avᄡm bv



cᄡᄡV^ᄡEi gj^ᄡvqb:3.2

A) eᄡ ᄡbeᄡPbx cᄡᄡe

mᄡᄡK D^ᄡEi ᄡbᄡ^ᄡ Rgj-K AᄡᄡiᄡᄡK e^ᄡᄡᄡqZ Kiab| Avcbvi ᄡbeᄡPZ D^ᄡEiᄡ K nᄡj (K) e^ᄡᄡᄡqZ Kiab:

- mwayᄡᄡZ nᄡ^ᄡQ fvlvi-
 K. K^ᄡ ifc L. ᄡjL^ᄡ ifc
 M. Av^ᄡᄡj K ifc N. gvᄡ ifc|
- Pᄡj Z iᄡᄡZ nᄡ^ᄡQ fvlvi
 K. cᄡᄡ ifc L. K^ᄡgvᄡ ifc
 M. Av^ᄡᄡj K ifc N. ᄡjL^ᄡ ifc|
- Av^ᄡᄡj K fvlv
 K. veKᄡᄡZ L. mᄡᄡsnZ
 M. AbᄡᄡZ N. gvᄡm^ᄡúbᄡ
- ÓᄡᄡZvg c^ᄡv^ᄡri bKᄡᄡᄡ ᄡj ᄡLᄡQb
 K. Kᄡj ᄡcᄡᄡbᄡᄡmsn L. cᄡᄡ ᄡPᄡᄡᄡ
 M. c^ᄡvi ᄡPvᄡ ᄡᄡᄡ N. ᄡmq^ᄡ gᄡZev Avj x|

cW 3.3

fvlv l ıkřlv

Dřřk

GB cW řkřl Avřub-

- cř_ıgK l gvaııgK chřq fvlv ıkřlv`řbi Dřřk eYřv KřřZ cviřeb;
- DřP ıkřlv chřq fvlv ıkřlv`řbi DcřřvMzv ıeeZ KřřZ cviřeb;
- mřvřZ, ıeÁvb l Křvi Mři ıkřlvq fvlvi , ıař;e`vL`v KřřZ cviřeb;
- cři fvlvi msÁv, `enkř Ges D`vri Y eYřv KřřZ cviřeb Ges
- Ářřbi ıeıřbakvLvq cři fvlvi e`enri Dřřk KřřZ cviřeb|

fvlv ıkřlv`řbi Dřřk

fvlv l Rıeb Mřxi řře mřřř l mřú³ | Avřřř`i Ařve-AıřřřvM, ıPřřř-řvebv, gZıgZ, Avb>`-AřřeM, e`_v-te`bv, bıPZv-`ıxbZv cřřvZ. gřbi AbyřřZ Ařř`i ıbKU cřřvK Kivi cřıvb gva`g fvlv| fvlv ıe`Křvi ıkřř, mřvřZ, ıeÁvb Ges cřıvř ıe`v ev řUKřřıj ıR ıkřřvi ıe`řři řve l ıPřřř, `řřZv l MřelYv Ges cřıvřK Křv-řKřkj cřřvřki cřıvb evřK l Aeř řb| ZıB fvlv ıkřlv`řbi , ıař;Acři mřg|

cř_ıgK, gvaııgK Ges DřP ıkřlv chřq fvlv ıkřlv`řbi Dřřk`i gřřS řřbřřv cřıj ıřřZ nq|

cř_ıgK chřq

cř_ıgK chřq ıkřřřK gřZřıv ıkřlv`řbi Dřřk nř`Q ZřřK gřZřıv i`břZ, eřřZ, cřřZ l ıj LřZ mřřg Křři řZıjv| A_řř tm-

1. gřZřıv i`řb eřřřZ cviřeb|
2. i`x l `ıúřřře eřřZ cviřeb|
3. `ıaxbřře cřřZ cviřeb|
4. mřı i l `ıúřřře ıj LřZ cviřeb|

Gi dřř ıkřř th řKıv ıelq ıbřř mřřR eřřřZ cviřeb Ges AcıřK řevřevi řřgZv ARř KřřZ cviřeb| gřZřıv řřı řře ıkřřř řıel`řZ th řKıv ıelq Aa`qb Kivl Zıv cřř mřR ře| gřZřıv AvqĚ KřřZ cviřř ıkřřıv Zıř`i Rıeb mřı l cřıcYřře Mřo ZřřřZ cviřeb| ıbřřı ř`k, RıvZ, ms`vZ l mřvřZ mřúřK`mřřPZb l křıvıkj nřq DVřeb|

gvaııgK chřq fvlv ıkřlv`řbi Dřřk nř`Q:

gvaııgK chřq

1. fvlvi AřřřřZ křř l `řřZřřK cřřıvRb Abyřřřı mřřře e`enri Kivi KřvřKřkj AvqĚ KřřZ ıkřlv`řK mřvřř` Kiv|

փ Ae GWՀKkb

2. Ի՞նչ քաղաքի ցածր Տնօրենքի ղեկավարը Վահագն Կյուրյանը:
3. Ի՞նչ քաղաքի քաղաքացի է Վահագն Կյուրյանը:
4. Ի՞նչ քաղաքի քաղաքացի է Վահագն Կյուրյանը:
5. Ի՞նչ քաղաքի քաղաքացի է Վահագն Կյուրյանը:

Դ՞՞՞՞ քաղաքի քաղաքացի է Վահագն Կյուրյանը:

D՞՞՞՞ քաղաքի քաղաքացի է Վահագն Կյուրյանը:

1. Ի՞նչ քաղաքի քաղաքացի է Վահագն Կյուրյանը:
2. Ի՞նչ քաղաքի քաղաքացի է Վահագն Կյուրյանը:
3. Ի՞նչ քաղաքի քաղաքացի է Վահագն Կյուրյանը:
4. Ի՞նչ քաղաքի քաղաքացի է Վահագն Կյուրյանը:
5. Ի՞նչ քաղաքի քաղաքացի է Վահագն Կյուրյանը:

Ի՞նչ քաղաքի քաղաքացի է Վահագն Կյուրյանը:

Ի՞նչ քաղաքի քաղաքացի է Վահագն Կյուրյանը:

Ի՞նչ քաղաքի քաղաքացի է Վահագն Կյուրյանը:

փ Ae GW#Kkb

evsjv fvlvi cwi fwl K ktai kZKiv ubivbeVB fvlMB maeZ AbvZ ka | evsjv`tk
cwi fvlv iPbv l msKjtbi Df`vM tbq lvtUi `ktK` փ cZovb: evsjv GKvtWgx l
tK`iq evsjv Dbqb tevW` Dfq cZovb KtqKwU cwi fvlv tKvl cKvk KtiZQ|

Avtbi wefbaqvLiq cwi fwl K ktai e`envi j փ Kiv hvq| G ka ,tjv mautK`avi Yv bv
_vKtj D³ nel tq AvbR⁸ maeCi nq bv|

MvZ

MvZ kv`i KQyKQycwi fwl K ktai e`envi Avgiv t`LtZ cvB, thgb- cvB (π), l tgmV
(ω), eÜbx [{{ ()}], ,YZK, ,YbxqK, eMgj- (\sqrt{a}), Nbgj- ($\sqrt[3]{a}$), mPK, tF` BZ`w |
MvZ kv`i Aa`qbKvtj փ փ iK Gme ka mautK`ek` avi Yv jvf KitZ nq
G ,tjvi e`envi Kti MvZkv`i AvbR⁸ KitZ nq|

c`v`e`v

c`v`e`v Aa`qbKvtj փ փ i nbgj mLZ cwi fwl K ka ,tjvi mvt` cwi Pq NtU-

cigvYyZvcK, tgiakw³, tP\$`K cEj` , cZmiY, cZdj b, tZRw`LqZv, Dòvqbx ubMgb,
Dòvqbx fij f, PzKxq Avtek, msKU tKvY, Zi½ `N⁹, M`vj fvtbmgUvi, tiva,
tcj mqvrti i փqv BZ`w |

fMvj nel tq e`euZ cwi fwl K ka ,tjv nbgj/c-

fMvj

j vfv, gvEKv, AMjcvZ, fvgKau, փkjv, tR`wZ⁹, Qvqv_, ubnvixKv, Dév, SuUKv AvMi,
Zvvgmv BZ`w wefbaqa mautK`avi Yv jvf Kti fMvj nel tq AvbR⁸ KitZ nq|
Dw`e`vq փQyeAvbK bvtgi e`envi t`Lv hvq| thgb-

Dw`e`v

tMvj vtc i`eAvbK bvg Rosa centifolia

Revi `eAvbK bvg Hibiscus rosa sinensis

kvcjvi `eAvbK bvg Nymphaea nauchali

GQrov Dw`e`v Avb cvW KitZ ntj փkl փQykā mautK`avi Yv jvf Kivi cQvRb
cti | thgb- AdtMU, t÷vj b, mvKvi, mgevE A½, cyúeb`vm, c0`^b, mvtj vK mstk dY,
ci vMvqb, fiBivm, e`vKtUvi qv BZ`w |

cWye`vq e`euZ փQykā nt`Q - tKvl, Kjv, gvBtUtk փqv, Mj փRwW, kxZwb`v, cRbb,
ubDwKqvm, RxebPμ, Av`g34v, KtkiaKv, Kivq, tiUbv, tj Y BZ`w |

imvqb kv` ,

imvqb kv`i hviv AvbR⁸ Kite Zvt`itKI փQyփkl ka mautK`Avbjvf KitZ nte|
thgb- nvBtWtKwi K GimW (HCl), mvj wldDwi K GimW (H₂SO₄), Av`tRb (O₂),
bvBtUtkRb (N₂), cvnb (H₂O), thvRbx, thvR`Zv, gj-K, mstkZ, cZxK BZ`w |

mwnZ`

tUtRwW, KtgmW, gtbvj M, mtbU, փg_, Gwck (Epic) BZ`w nt`Q mwnZ` e`euZ փkl
ka |

gtbwe`v

gtbwe`v Aa`qb Kvtj mvariYxKiY, `ZüZ` cgyvMgb, mvm`KiY BZ`w փkl
ka ,tjvi A` G ,tjvi e`envi mautK`avi Yv jvf Kivi cQvRb cto|

KřřRB GıU `úóB cřřxgıv nř"Q th, Ávř weÁvřbi weřřbřkřvLıv cııı fıvl K křäi e`envi thgb Acııı nıh,°tm m=úřK°arı Yv j vřl tZgıv , i aZřYř

dv, řřbi cŔĚ ävi Yv t_řK Avgıv RıvřZ cııı th, fılv AvıřbKıKıY cŔıııııı GK eo Dcř`vb nř"Q weÁvř, cŔKřkj I Ab`ıv` AvıřbK kv`;PPř Dcřřıııı cııı fıvl K kř ä mıř I kř MVřbi bZb řKřkj D`řeb|



cřřVřĚi gj`ıqb: 3.3

A) eú vbeřřbx cřřæ

mııK DĚi vřř`řgř-K AřřıııřK eĚııııZ Křıab| Aıvıvı vbeřřZ DĚiıı K nřj (K) eĚııııZ Křıab:

- 1| cııı fıvl K křäi cřvb `eıřkó" nř"QŇ
 K. bıv`ııK řmř`h° L. AvřeMgq kř ä mıř
 M. GKřııK A_řn GKıı kř N. h_vh_ I mıřavRbK kř|
- 2| Cohesion-Gı cııı fılv
 K. e`KıY L. msj vřřııııı
 M. mg`KıY N. msj ob|
- 3| evsj vř`řk cııı fılv msKj řbi Dř`ııı řbı qı nq-
 K. Pıj řki `křK L. Iıřııı `křK
 M. Avıki `křK N. weřk kZıřäřZ|
4. cııı fıvl K křäi eo `eıřkó" nř"Q-
 K. we`ıZ. L. cııı vřřııı
 M. mřııııı N. cřřııı|



Přıřřııı gj`ıqb

iPbıııı-K cřřæ

1. gıv fılv I Av`ııı K fılvı `eıřkó" I mřÁv cŔıııı Křıab|
2. Dcřřııı I gıv fılvı Drcııı m=úřK°arı Yv ı b|
3. mıııı Pıj Z ııııı cııı`R` eYřv Křıab|
4. fılv ııııı vřřbi Dř`ııı eYřv Křıab|
5. cııı fılv ej řZ ııı eřııı? Ávřbi weřřbřkřvLıv cııı fılvı e`envi Dřřıı Křıab|

mııK DĚi

cřřVřĚi gj`ıqb 3.1: 1| L 2| N 3| K 4| N
 cřřVřĚi gj`ıqb 3.2: 1| L 2| L 3| M 4| K
 cřřVřĚi gj`ıqb 3.3: 1| N 2| L 3| L 4| M

figKv

gtb Kiab Avcub imtjU tRjvi tKvb GKiu Mti gi t qj ukqKZv Ki tQb| Avcbvi Qv i v
 H AAtj i AvAnj K fvlvq K_v ej tZ Af t l gvb fvlvi mt_ Zvt` i cwiPq tbB| Avcub
 hLb Zvt` i tK cvV` vb Ki t eb ZLb Avcub tKvb fvlv e`envi Ki t eb? h w AvAnj K fvlv
 e`envi Ktib Zvntj gvb fvlv ev cytKi fvlvi mt½ Zvt` i cwiPq NUte bv| Aciw tK
 gvb fvlv h w Avcbvi cvV` vbi gva`g nq Zvntj Zv Qv i t` i KvtQ ` t e l a` gtb nte,
 thtnZzZviv cytKi fvlv ev gvb fvlvi mt_ cwiPZ bq| Gt q t t Avcbvi Ki Yxq uk?
 tkiYKtqi cvV` vbi fvlv uk n l qv DWPZ, Dc` vctb tKSkj ev cvV` vb cxwZ tKgb nte
 BZ` w` bvbv w el tqi Dci w f i E Kti GB BDibUu tK wZbu cvtV f i M Kiv ntqtQ| GB
 cvV` t j v nt` Q:

cvV- 4.1: tkiYKtqi cvV` vbi fvlv

cvV- 4.2: Dc` vctb ` qZv l evPb tKSkj

cvV- 4.3: fvlv ukqY cxwZ

ṽ Ae GWžKkb

ṽúo I i× D'PviY

Qvĭt' i D'PviYi μϑ ṽ Kivi Rb" ṽKḡK ṽb†R ṽúo I i× fvlvq cV Dcṽcb
Kiṽeb| Qvĭ-Qvĭxṽ i†K GKĭt' ṽetkl K†i KṽeZv mgṽ†i cV Ki†Z ṽṽeb| GKĭ c†Vi
Dc†iB ṽetkl tRvi ṽ†Z nṽe, KviY Gi ṽviv cĀZU Qvĭ-Qvĭxi KÉṽ† I D'PviY ṽṽl,
ṽRnYi AvoóZv Ges c†Vi Abṽb" ṽṽl μϑi m†kṽab I cwiḡvR†bi m†hVM N†U| Qvĭ-
Qvĭxiv Zṽt' i c†Vi mgq h†Z tKvb k†āi Ai× D'PviY bv K†i tmṽ†K tLqj ivL†Z
nṽe| c†i cVṽṽbi mgq ṽKḡK ṽb†R cĀṽḡ Zv cV K†i tkvbṽeb, AZci Qvĭt' i†K
Zv cV Ki†Z ṽṽeb Ges D'PviY tKvb μϑ ṽK†j ṽKḡK Zv i†āi ṽṽeb|

**mnR fvlvq A_ḡ
eḡṽbv**

mṽYḡcVvUṽi avivevṽK ṽetkl†Yi ṽviv k†āi A_ḡ cĀkṽe mṽv†h" fve D×vi K†i ṽKḡK
mgMṽcVvUṽ†K Qvĭt' i Kv†Q ṽúo I cĀĀj K†i Zṽṽeb| A_ḡṽb kṽ A†cḡṽ Kṽb bv nq,
tmṽ†K tLqj ivL†Z nṽe|

**mṽúo I cĀvgjK
cĀkṽe**

c†Vi fve I ḡḡvṽvi Ges ṽbaṽiZ c†Vi Ávb†K ṽvq, ṽúo I cḡṽiZ Kivi cṽb
nṽvZqvi n†jv cĀḡ ṽKḡK cVṽṽbi ḡvSLṽb ṽKḡṽ_ṽṽ i†K Ggb fṽe cĀkṽeKiṽeb h†Z
cĀkṽeḡ ḡḡḡj cĀek K†i ṽPŠṽ, ṽṽḡ I Av†e†Mi D†K K†i A_ḡ Qvĭ-Qvĭxṽ i†K
ṽPṽŠZ, ṽṽṽ I Av†eMṽxṽ K†i c†Vi ṽbṽṽ ṽelqṽi ḡḡDcḡṽṽZ mṽv†h" K†i| ZvB
cĀkṽemṽxṽyṽ I mṽúo Ges ṽPŠṽ I cĀvgj-K nṽe h†Z AṽúoZv ev ṽṽṽe cĀkṽki
tKvbifc AeKṽk bv ṽṽK|

**mnR I cĀĀj cV
Dcṽcb**

cV D†Zi ṽcU Qvĭ-Qvĭxiv KLbB mn" Ki†Z c†i bv| tmUv cĀḡK ṽ†iB tṽK A_ev
ḡṽḡK ṽ†iB tṽK| ṽKḡK hṽ Qvĭt' i ṽ†i tḡḡ ḡṽm AvŠṽiK I N†ivqṽfṽe im†jv
K†i cV Dcṽcb K†ib, ṽKḡ†Ki cVṽṽbi fvlv hṽ mnR Ges cĀĀj nq, Zv†jB
Qvĭt' i ṽṽ I ḡb m††RB c†Vi ṽṽ†K AvKó.nṽe|

RṽešDcṽcb

ṽKḡ†K GKṽ me mgq ḡṽ ivL†Z nṽe th cVṽṽbi fvlv Ges ejvi fṽzi Dci ṽb†P
K†i cVṽṽ ṽelqṽU Rṽeš n†ḡ D†V| cVṽṽbi fvlv Ges Dcṽcb Ggb nṽe h†Z
ṽKḡṽ_ṽṽ i tP†Li mḡḡb cVṽṽ ṽelqṽU Qṽei ḡ†Zv fṽ†m|

Dĭxc†Ki ṽePĭ

cV Mḡ†Yi KvRṽU Qvĭt' i Kv†Q h†Z GK†N†ḡ I KṽŠKi n†ḡ bv D†V Ges Zṽt' i
ḡṽb†hṽM h†Z ā†i ivLv hḡ tm Rb" c†V ṽePĭ cṽDĭxcK cĀqṽM cĀqṽRb| GB ṽK
ṽe†ePbv K†iB ṽKḡ†K i†K Dĭxc†Ki ṽePĭ Avbri cĀkḡY ṽṽlqv nq| GB ṽePĭ
ṽṽṽbṽṽe Avbv hḡ| thgb- KÉṽ†i Av†eMḡ I Vbvḡv, ṽbḡḡbM Pjṽ†div, Qvĭ†i
AskMḡ†Yi m†hVM ṽb, avivevṽK fṽe Bṽṽḡmḡ†ni eṽenvi, thgb- cĀḡḡ kṽY I c†i
ṽkṽ- DcKiY eṽenvi BZṽṽ|

A†bK ṽKḡK Lḡ teṽK Kṽ etj b| GB Afṽm cṽieZṽbi Rb" bṽieZv cḡb I A†ḡŠLK
BṽṽZ ṽṽbi cĀkḡY ṽṽlqv nq| bṽieZvi tKŠkḡU hṽ mṽV K I mḡḡṽPZ fṽe cĀqṽM
Kiv hḡ Zv n†j A†bK mgq Kṽi P†B†Z A†bK teṽK Kvḡḡi dj ṽṽq|

**gub fvlvq cvV
Dc`vcŕbi
cŕŕqvRbxqZv**

my`i I gvrRŒ K_` fvlŕŕZ ev gub fvlvq cvV`e`Dc`vcb Kivi cŕŕqvRbxqZv űbgŕŕc:

1. tkŕŕYKŕŕŕ űewfbae`ŕi i Qvŕ-Qvŕxiv hvŕZ fvlvi tgŕŕLK iŕc`ŕŕZv ARŒ KiŕZ cvŕi Ges my`i evPb-fŕŕxi mŕŕ_ cwiŕPZ nŕZ cvŕi |
2. gub fvlvi mŕŕ/2 Qvŕŕ` i cwiPq bv NUŕj evsj v, Aŕ/4, űeÁvb, mgvR tKvb cyŕKB Zvŕ` i KŕŕQ tevallg` nŕe bv |
3. fvlvi i x iŕŕci mŕŕ_ cwiPq hZ my`i I gvrRŒ K_` fvlŕŕZ nŕe Zvŕ` i űPŕŕŕ ZZ`Q I MŕZgq nŕŕ DVŕe |
4. gub fvlv AvqE` KiŕZ cvŕŕj B Qvŕiv AvakZi Mŕŕ` cvŕV AvMŕx I tKŕZnjx nŕŕ DVŕe |
5. fvlvi i x iŕŕci Abŕŕj b Œriv AvZŕcKŕŕki`ŕŕZv ARŒ KŕiB gubŕy Zvi mvgvrRK, gvbŕeK, `kŕŕ K Ges`bvZK , Yvej xi űeKŕk NUŕŕZ cvŕi |



cvŕVvEi gj`vqb: 4.1

A) msvŕŕŕB DŒi cŕŕe

1. tkŕŕYKŕŕŕ cvV`vb gub fvlvq nI qv DŕPZ tKb?
2. űkŕŕK`úó I i x fvlvq cvV`vb Kiŕeb tKb?
3. cvV`vŕb DŕŕŕŕKi`evŕŕ` Avbvi cŕŕqvRbxqZv űK?
4. gub fvlvq cvV Dc`vcŕbi cŕŕqvRbxqZv űK?

cW 4.2

Dc փcb փZv I evPb tKŠkj

Dժիկ

GB cW tkժI Avcb-

- ԿՊԻKi cV Dc փcb tKgb nI qv DւPZ tm mսւտKՅj իZ cvi օeb;
- Dc փcb փZv ARՖbi Rb՝ ԿՊԻK tKvb tKvb ւելtqi ւ իK bRi ւ ձeb, tm mսւտKՅ avi Yv ւeeZ Ki իZ cvi օeb Ges
- Qvժի իK mյi evPb փZ I evKkwՅ AvqԷ Kiv օbvi tKŠkj ev Dcvq,tjv Dժի K իZ cvi օeb|

ԿՊԻK Dcvտq cW Dc փcb

GKւU cV ԿՊԻK I ԿՊԻԱb nI qv mսւտKՅ ւb փP Kժi ԿՊԻK-ԿւՊԻK փi mյւսՅZ cւի Kիbv Ges ւելqe փi imտjv Dc փcbi Օրiv Qvժի-Qvժի փi KgZrci Kժi իZvjvi Dci | imտjv kժի A_Յj mim, imgq A_Ֆ Avb>`gq| Avi imտjv bv ntj tKvb ԿՊԻK gայ I mյր` ynq bv| cV տbi տՊԻ I GUv mZ՝ | Qvժի-Qvժի Mժի AւAK Avb>` cւq| Gi Օրiv Zվի AvՓM Dժի mZ nq; cV`e` ü`qMժx I ԿՊԻK nq| ZvB Mի I AvՓM Dժի փbi Օրiv cվի ւելqe փi cւի տkb Kiv`i Kvi | ՕG t`k Avgvi Օ KւeZւի cV i iæ Kivi mgq t`kvZՖevaK`ՅGKւU Mvb, thgb- ՕAvgvi t`ժki gւի Mժի փi AvժQ miv gbՕ A_ev ՕI Avgvi t`ժki tmivbv dj ժe t`ժki իժՕ ԿՊԻK-ԿւՊԻK ւbR tUcti Kւի i mivտի Qvժի-Qvժի փi tկvտZ ev`ՅGKւU t`kvZՖevaK KւeZv հւ` AveւԷ Ki իZ cvi օb, Zժe DՅ KւeZւի cV`vb imտjv nte mժ`n tbB| cժիZ: Dժի tհvM` th, gvZփvի ԿՊԻK Ab`Zg ,Y nt`Q Mvb MvժZ cւiv Ges mյi փi KւeZv AveւԷ Ki իZ cւiv| Kvi Y mժx I AveւԷi Օրiv Qvժի-Qvժի փi փi I AvՓM mnժRB RւMՅ I Dժի Kiv hvq| Avi cժqRb ntj gvZփvի cV`vb Kվj cժիZ`ՅGKւU Mvb Ki իZ ԿՊԻK ԿւՊԻK փi KLBb mժի Pժeva Ki օeb bv| Kvi Y mժxZ kժի D`Pvi Y mյg I aՅbmժZ nq| Qvժի-Qvժի փi փi-Rxb Mvժbi mKj i Kg mժe` Dcvq Zվի իK Ae j ժb Ki իZ nq| tցւK_v cV տbi cւZ Dժի փi I Gi ev`եղb GKւՅB ւb փP Kժi ԿՊԻK-ԿւՊԻK փi mRbx I Dժի փi kւՅ, Avժի KZv Ges cժիZ cւgւZ ժի Dci |

Dc փcb փZv ARՖbi Rb՝ ԿՊԻK ւbgւj ւLZ ւելq,tjvi cժ bRi ւ ձeb:

Avժի KZv gյ փv

1. D`Pvi ժի mվ_ Avժի KZv Mփi փi RւoZ| Avժի KZv փv փZվK cժի mZ Kժi | KվRB Dc փcb փZv ARՖbi Rb՝ ԿՊԻK փv hvժ Avժի KZv gյ_վK tm tՓv Ki իZ nte|

i x Pij Z փv e`envi

2. ԿՊԻK i x Pij Z փv K_v ej իZ nte| Avժի K փv փv փv e`envi Kiv ի իZ cւի | Կժի ւe`յ ժi cւi bv I Ab`vb` mg`I KվR i x Pij Z փv e`envi Kiv DւPZ| bZev ԿՊԻK փv i x Pij Z փv փv փZv ARՖ Ki իZ cvi օeb bv|

úó D'PviY

3. ejvi mgq **ukʒKtK mKj tʒtĭ** `úó fite kã I evK` D'PviY KiĭZ nte| A`úó D'PviY tkĭZv ešĭZ cĭti bv| tkĭZv hw` e³e` ešĭZ bv cĭti Zvntj ejvi Dĭk` cĭY nq bv| tm Rb` `úó fite D'PviĭYi Abĭxj b Kiv` iKvi|

KÉ`ĭi ĩfmeKZv

4. cĭV Dc`ĭctbi tʒtĭ KÉ`ĭi ĩfmeKZv eRĭq ivLv GKĭU ĭazcY`e`ĭcvi| **ukʒKtK** memgq tLqj ivLĭZ nte tkĭYĭZ cĭV`ĭtbi mgq **ukʒKtKi KÉ`ĭ** thb Rĭotq bv hvq| Rĭotq ev ZvovZĭmo K_v ejĭj tkĭZvi cĭĭj Zv tevSv gĭĭKj nte| ZvB memgq ĩfmeK fite K_v ejĭZ nte|

veI qvbĭZv

5. Dc`ĭctb `ʒZv ARĭbi Ab`vb` ĩĭKi gĭa` **veI qvbĭZv** **veĭkI cĭqvRbxq| AĭbK** mgq t`Lv hvq tKvb e³v ĩbaĭĭZ **veI q** Qĭotq AĭbK `ĭi Ptj hvb A_ev **veI q** m`úĭK`**ukʒ** etj b bv| cĭqvRbxq K_v ev` ĩĭq AcĭqvRbxq K_v etj mgq bó Kĭib| GĭZ tkĭZvi `ah`PĭZ` NĭU| KĭĭRB GB **veĭkI** ĩ Kĭĭi cĭZ tLqj tĭL **veI q** Abĭvq hZUK`zej v cĭqvRb ZvB ejvi Abĭxj b KiĭZ nte|

kjxbZv eRĭq ivLv

6. cĭV Dc`ĭctbi mgq **ukʒKtK tLqj** ivLĭZ nte **veeiY, eYĭv, Avĭj vPbv, veZK`hvB** trĭv bv tKb ejvi mgq thb **kjxbZv eRĭq** `ĭK| **ukʒvi Ab`Zg j ĭĭ** mĭgĭRKZv| **kjxbZv mĭgĭRKZvi A½|** ZvB K_`veiZ`ejvi mgq **kjxbZvi ĩĭK Aek`B tLqj** ivLĭZ nte|

mĭi evPbfĭzi Abĭxj b

7. cĭV Dc`ĭctbi Rb` Aek`B mĭi evPbfĭzi `iKvi| Abĭxjĭbi gĭa`tg aĭĭi aĭĭi fĭlv `ʒZvi `YĭKLĭi I v m`e| e³e` mĭi Kivi Rb` cĭZkã, D`xĭZ, tKŠZK BZ`ĭ` e`envi Kiv hvq| K_v ejvi mgq tLqj ivLĭZ nte GKĭNĭq K_v ev GKB **veI q** cĭvĭeĭ thb bv NĭU| tKD AvĭvZ cĭq ev **vei³** nq Ggb K_v KLbI **ukʒKtKi** ejv DĭPZ bq| **ukʒK** hw` Gfite ejvi **veI q** ĭjv Abĭxj b Kĭib, Zvntj Dc`ĭctb `ʒZv ARĭ **Aĭbevh`**

mĭi evPbfĭzi I evKkĭ³ AĭĭE Kiĭbvi Dcĭq:

mim Dc`ĭcb

1. **ukʒK** cĭĭvi **veI q** `mim I **ĭPĖvKIĭ** Mĭi gZ mĭi Kĭi Dc`ĭcb Kĭe Ges evPbfĭzi mĭ_ Zĭĭ`i cĭĭĭPZ nĭZ mĭvĭh` Kĭe|

gĭRĭ I cĭĭ`QbãK` fĭĭZ Dc`ĭcb

2. cĭĭg tkĭY t_ĭKB hvĭZ Qvĭiv gĭL gĭL Mĭ etj gĭbi fĭve ĩbĭRi fĭlvq cĭĭvK KiĭZ cĭĭi G e`ĭcĭĭi Zĭĭ`iĭK DrmĭvZ Kĭi ZĭĭZ nte| **ukʒK-ukʒKv ĭĭcK_vi** Mĭ ejĭeb, Pĭĭ` hvĭvi K_v, `eÁĭbK Avĭe`vĭĭi tĭvgĭĀKi **veeiY** ĭmĭĭjv Kĭi gĭRĭ I cĭĭ`QbãK` fĭĭZ Dc`ĭcb Kĭeb| GBfite ĭĭb Ges mĭ½ mĭ½ **ukĭL** fĭlvĭ tgŠĭLK ĭĭĭci mĭ_ Qvĭ-Qvĭiv cĭĭĭPZ nte| **ĭPŠĭi** `^QZv I tmŠKh`fĭlvĭ gĭRĭ K_` fĭxi `^Q` e`envi Kĭj Zvi Dci **veĭkI** fite ĩbĭf` Kĭi|

Mĭ ejv veZK`KĭeZv Aĭveĭi AvĭqvRb

3. ĩbĭPi tkĭY nĭZB Mĭ ejvi Kĭm, **veZK`mfv, ĩĭPZ KĭeZv** ev tQvU tQvU cĭĭÜ cĭV, tQvU LvU bvU`vbĭvb BZ`ĭ`i e`e`v Kiv thĭZ cĭĭi|

fĭ ĭxKiY

4. mĭvntZ`i cĭV`vb Kĭĭj Qvĭ-Qvĭĭĭ`i cĭĭZ Ges kĭãi Av`k`D'PviY ĩĭq Zĭĭ`i fĭĭ ĭx Kĭi ĩĭZ nte|

m½xiZ I KueZv AveŲE

5. m½xiZ evKkũ³ jvf I epxi Ab Zg cõvb Dciq I Aej õb | m½xiZ I KueZv AveŲE i
Qviv kã Z_v aŲibi I Rb mãtÜ tek ᐱó GKũU aviYv jvf Kiv hñq | fve, A_© I
AvteM AbŲiqx aŲibi Zi½Z ifc evKkũ³ i ù½Z©I ejj õZv weavb Kti |

gšLi K_v hZ ᐱó I cõAj nte, gšbi K_vl ZZ Aeva I ù½Z©j vf Kite | Avgiv hLb
ñj űL, ZLb gšb gšb Zv ewj | tmRb tj Lvi cte®gšLi I gšb K_v ejvi Afim I ᐱQZv
mšvrafvte mũbœKižZ nte | KviY űõavxb evPb f½xi Dci űj Lb f½xi mimZv I
cõAj Zv AtbK cwi gvŲY űbfP Kti | ᐱgš evKkũ³ ev evPb f½xi ű ĩK tZgb ᐱó t l qv
nq br etj Avakisk QvŲ-QvŲxB evKšvRš Ges evPtb űKZ. I weãvšl nŲq cto | ejvB
evŲj ᐱKŲK-űKŲŲKvi evKkũ³ Ges evPb f½xi h_vŲhűM I h_vmœe mš i n l qv DŲPZ | MŲ
ejv ev cvŲVi Dc ᐱcb imŲj v ev űPÉvKIŲ KižZ nŲj hŲó evKkũ³ Ges mōzl gvRZ
evPb-f½xi Avakix nžZ nte | GŲŲŲŲŲ űKŲK-űKŲŲKviMYŲK AZ Ųšl mRvM I mŲPZb nžZ
nŲj | KviY QvŲ-QvŲŲŲŲ i eũ³ Z; űKvK ZŲŲ i evKkũ³ I evPb f½xi μtgvbũzi Dci
meštk űbfP Kti |

c_K cv

6. evKkũ³ epxi I evPb f½xi cwi gvRšbi Rb cŲK cv Acwi nuhP űPűvCŲ, cv cŲK,
MŲ, buUK, Dcbim cŲvZ. űbqũG cvŲv QvŲŲŲŲ i Drmrvx Kti ZšžZ nte |

mie cv

7. cv ᐱgš i Kšg nŲq ᐱŲK, miš Ges bxite | evKkũ³ i DšbŲ I epxi Rb mie cv
Ges űPšl kũ³ i ᐱZZv I μtgvbũzi Rb bxie cvŲvi cŲqvRb | ű ᐱvj tqi cŲũgK I
gvaũgK ŲŲ i evKkũ³ jvf i Dci űŲkl , iãž; AvŲivc Kiv i Kvi etj G mgq mie
cvŲvi Dci tRvi t l qv DŲPZ |

mg_Ųi cv

8. cŲũgK ű ᐱvj tq mKj QvŲŲŲŲŲ i ĩK tkŲYKŲŲ mg_Ųi KueZv cv KižZ ű žZ nte |
GKŲ cvŲvi Dci tRvi ű Ųj cŲZũU QvŲ-QvŲxi KÉ_Ų I DʹPviY Ų űv, űRnŲvi
AvooZv Ges cvŲvi Abvb ᐱ űv μũDi mškvab I cwi gvRšbi mšhűM NUte |

9. QvŲiv GKRB GKRB Kti tkŲYi mœšL Gšm ᐱűšq eBŲqi tKvb GKũU Ask tRŲi
tRŲi cv Kiž DʹPviŲYi Ų űv ŲũU ᐱ nŲe Ges RoZv Kvũte |



cvŲvEi gj_vqb: 4.2

1. gvb fivq cv Dc ᐱcb i cŲqvRb qZv Kx?
2. mš i evPb ŲKškj AvqE Kivi Dciq eYŲv Kiab |
3. Dc ᐱcb ᐱŲZv ARšbi Rb ᐱKŲK ᐱK űK űel tqi ű ĩK bRi ű Ųeb?

cW 4.3

fvlv ukʒY cxiZ

Dʒik

GB cW tkʒI Avicib-

- ukʒv`vb cxiZ I tkʒkj ej tZ uk eʒvq Zv ej tZ cvi teb;
- ukʒtʒYi ukʒK tkw`K ev mbvZb cxiZ Ges ukʒv_xʒKw`K ev AvapK cxiZ ej tZ uk eʒvq Zv e`vL`v Ki tZ cvi teb;
- c0_ugK I gva`ugK chʒq fvlv ukLʒbi cxiZ, tʒv Dʒj L Ki tZ cvi teb|

civ Dc`vctbi cʒeʒukʒKʒK KZ, tʒv nel tqi w`tK bRi w`tZ nq-

- civʒvi nel qe`uk
- Kiv`i tK covʒZ nʒe
- uk Dʒi tK covʒZ nʒe
- civ`vʒbi Rb` uk DcKiY e`envi Ki tZ nʒe
- ukfvte ukʒv_xʒK gj`vqb Ki tZ nʒe BZ`w` |

ukʒY cxiZ

Gme nelq weʒepbv Kʒi ukʒK bivbri Kg Kʒvʒtkʒkj I cxiZi ga` w`tq ukʒv_xʒ i tK civ`e` AvqEj Ki tZ tPov Kʒib, hvʒK ej v nq civ`vb ev ukLb cxiZ| thgb- tkwYKʒʒ ukʒK KLbi eB covʒZ w`tq, KLbi e³Zv w`tq, KLbi c0kwe`i ev gZ weibgtqi gva`tg, KLbi nʒtZ Kʒ tʒ Kiv R w`tq civ Dc`vcb Kʒib| GmeB nʒ`Q ukʒv cxiZ| ukʒY cxiZ tK ukʒtʒKi GK aitbi tkʒkj ej v hvq| cxiZ I tkʒktʒi gʒa` civ`R` AvʒQ| tkʒkj cxiZi Aʒʒʒ| thgb- civʒvi c0Z AvM0` Zwi Kiv, Dchʒ I KivhRix DcKiY e`envi Kiv, Mʒ ej v, eY0vi gʒa` buUKxqZv mʒ0 Kiv, A1/2xi e`envi Kiv, nel qe` Abʒvqx KE`ʒii DVibvqv Kiv, `emPʒ`cʒ`c0Kiv- GmeB nʒ`Q tkʒkj |

ukʒY tkʒkj

tkʒkj, tʒv ukʒY cxiZ tK KivhRix Ki tZ mrvv` Kʒi | Zʒe me tkʒkj me cxiZi Rb` DcʒhvMx bq| cxiZ nʒ`Q Dʒi k`gʒx| ukʒK hv` Dʒi k` Abʒvqx tkʒkj, tʒv tK `ʒZvi mʒ_ e`envi Ki tZ mʒig nb Zvntʒ B ukʒY cxiZ tK mdj Kʒi tʒv mʒe|

ukʒv`vb cxiZ `ʒ c0vi |

- (1) ukʒK tkw`K cxiZ
- (2) ukʒv_xʒKw`K cxiZ|

ukʒK tkw`K cxiZ

ukʒK tkw`K cxiZ: G cxiZ tZ ukʒKMY ukʒY ukLʒbi tʒʒi gE` figKv cij b Kʒi _vʒKb| Qvʒi` i tK bxie tkʒZv I `kʒKi figKvq ti tL Ges ukʒKMY tenki fWM mgq mʒuq t_ tK civ`vb KivhRix civ`Pvʒ bv Kʒib|

փ Ae GWԻKkb

ԻԿՂՎ_ՄԳԿԽ՝Կ ԸՎՈՂ

ԻԿՂՎ_ՄԳԿԽ՝Կ ԸՎՈՂ: th ԸՎՈՂԻZ QvTİi eqm, tgav, mvg_© i fP, AwfÁZv, AvMò, AvteM I cèYZvi K_v ԻPŠİ Kti Ges QvTİK mւււզZvi gta" tiTŁ Zvi ԻԿLtb mնvզZv Kiv nզ Zv nj ԻԿՂՎ_ՄԳԿԽ՝Կ ԸՎՈՂ |

ԻԿՂԿ ԻԿԽ՝Կ ԸՎՈՂZ nT"Q mbvZb ԸՎՈՂZ Ges ԻԿՂՎ_ՄԳԿԽ՝Կ ԸՎՈՂZ nT"Q AvայԽԿ ԸՎՈՂZ |

mbvZb ԸՎՈՂ

mbvZb ԸՎՈՂ: e³Zv I cŁkò ԸՎՈՂZ nT"Q mbvZb ԸՎՈՂZ |

AvայԽԿ ԸՎՈՂ

AvայԽԿ ԸՎՈՂ: AvTj vPbv, cŁkuÈi, chբեՂյ, cixՂյ, cØR±, fւցKււրfbq, ԻԿՂՎ mdi, ԻԿI vi MւtUò, gTEmix- G_ tјv nT"Q AvայԽԿ ԸՎՈՂZ |

tKvb ԸՎՈՂZB փsmսւYբq |

ԻԿՂյ-ԻԿLb KւհբւգTԿ mdj KւTZ nTj cvV'e- Ges ԻԿՂՎ_ՄԳ i gb-gvbւmKZvi Dci Իււրİ Kti GKւաK ԸՎՈՂZ Aej սԾ Kivi cØqvRb cto |

fvlv ԻԿՂյ ԸՎՈՂ

gvZfvlv ԻԿՂՎ_ՎԾ ԸՎՈՂZi cււKİbv Ges Gi ev-ըvqb mսւYբրte ԻբfՓ Kti ԻԿՂԿ ԻԿԻՂԿւT i AvŠİi KZv, փ-ԻԿԶv I փ-ԻPŠİbi Dci | QvTİ i gb tKvb Ae-րq, KLB-ԻԿfւte mvoւ Ի te tմւTԿ j Ղ" tiTŁ ԻԿՂԿTԿ ԸՎՈՂZi K_v fւetZ nte | tՂTİ ԻեTԿtI ԻԿՂԿ ԻբR-^D"ԻեZ ԸՎՈՂZ Aej սԾ Kiteb | cØւցK chբq ԻԿİT i gTbi ԻTԿ ZււKtզ ԸՎՈՂZ D"Իեb bv Kiv nTj Zv ZvT i KւTQ Avb>-րqK nզ bv Ges ԻԿՂՎi mւT_ Avb>-bv _vKtj Zv KLBi QvTİ i KւTQ ԻPÈvKİR ev MòYtիւM" nզ bv | fvlv ԻԿՂTյi tՂTİ Իbgւյ ԻLZ ԸՎՈՂZ, tјv Aej սԾ Kiv հւզ-

evK" ԸՎՈՂ

(1) evK" ԸՎՈՂ: fvlv cŁek c_ aՎbi ԻււZi Իtզ i iænz | fvlv ejTz thTnZzKZ, tјv A_ճ Bւ½ZcY՞aՎb eՏւզ, tմտZzGi mնրտիB fvlv teva I cvTvi cèZò Kiv DւPZ | GLb cØg cvV`տbi ԸՎՈՂZ ԻK nte t`Lv hvK | iagvT aՎbTԿ fvlv Իււրİiբc aitj ԸՎՈՂZ eY՞ԻբfՓ nTզ cto A_թ -† I e`Äb eY՞ԻԿTŁ Ges Gi mւT_ Nւbòfւte cւււPZ nTզ ԻԿi cieZւTZ kà Ges kTāi cieZւcŁւկ ԻնTմte evK" AvգÈj Kti | kà fvlv Իււրİ nTj cvV`տbi ԸՎՈՂZ nte kà ԻբfՓ A_թ AvtM kà, kTāi ԻեTԿtY eY՞ Ges tkTl evK" | ԻԿŠ ԻեÁvbmսZfւte ejTz tMտj GKւU mսւYբevTԿ" ԻԿi Zvi gTbi fւe cŁւկ Kti ev KւTz tPóv Kti | ԻԿi i KւP gTLi Avտav Avտav tevj Ges gլvեetii aՎb KսւTbi gta" B GKւU cY՞evTԿ"i AvteM tek -úofւte aiv cto | GB Avտav Avտav tevtj i KւiY-†fc ejv thTz cvTİ th -úo I mսւYբD"PւiTյi Rb" gլv Իեetii ԻււրfbæAsk Ges KÉZŞj ZLb chՏj mej I mւււզ nTզ DVtZ cvTİ bv | Zv nTj evK" ԻբfՓ ԸՎՈՂZ ԻԿՂՎե`T i gTz ԻեÁvbmսZ etj MòY Kiv հւզ | cØg cvV i iænlqvi AvtMB Qւe I ԻււրPİ -k`iբci mնրտի" ԻԿi tek ԻԿQykā mսւT i AւաKւix nզ | th mKj cւււPZ kTāi Dci Իււրİ Kti evK" ԸՎՈՂZi cvV i iænte | GB cvTvi bgլv Իbgւբc:

GUr eB/
Avgvi eB/
GUr Avgvi eB/

evK`tK tK>`Kti gtb i PŠí AveuZŹ nq| ZvB evK` nŹ ŵkii ŵkŷv`ii iæ| GB c×uZtZ
QweB teŵk K_v ej te Ges evK` Gi evnb nŹq KvR Kite|

evK` c×uZi mvdj` ŵbfP Kti ŵkŷtKi `ah°l cŹzcbgŷZvvi Dci| GKuW m×úY°evK`
teŵW°A_ev KvW°teŵW°ŷj tL ŵkit`i mvgtb evievi Dc`vcb Kitj evK`uW mŵt_ Zvŵ`i
cwiPq NUte Ges evK`i mŵt_ cwiPŷqi mŷhvM tKŠktj ŵkit`i tK eY°cwiPq ŵkŷv`w`tZ
nte| thgb- gvQ atí, gŷuQ Dto|

evi evi teŵW°l KvW°teŵW°ŷ tL ŵkii v evK`i Aŵ_P mŷ½ Ges tmB mŵt_ Av-Kvi, B-
Kvi l G-Kŵtíi mŵt_l cwiPZ nte| Gfvte Zviv AMŷhi nŹZ _vKte| GB c×uZi
Dŷík`B nj ŵkii ŵkŷv`l AMŷuZ mnR Ges`ŵQ` l Avb`gg Kti tZvj v|

tc-l tq tg_w

(2) tc-l tq tg_w: G c×uZtZ tLj vi wŷZi w`tq AuZ mnŷR l Avb`i mŵt_ eY°cwiPq
Ges Qovi mivŵth` aŷŷi mŵt_ ŵkit`i cwiPq NŷU| evsjvi eY°tjv KvV w`tq Ges Gi
mŵt_ GK GKuW eŷY°P cwiPŷq gvby, ci l cŷuL GtK tLj vi Qŷj eY°kã Ges evK`i
ŵkŷv`nŹZ cvŷi, mŷ½ mŷ½ tLj l Awe°ŵŷi Avb` ŵkii v Avil Rŷbvi Ges ŵkLvi Rb`
Dŷy nte| tKvb tKvb cŷuŷgK we`ij tq fvlv ŵkŷv`ŵŷi mivŵth` ŵntmte eY°kã l
evK`_ŷj i½xb Qwei`k`cŷU dŵŷtq tZvjv nq| ŵKŠ`GtZ`i ayŷPŷLi ZŷB. l ŵkŷv`nq,
mg`lgb l t`n GK mŷ½ KvR KitZ cvŷi bv| ŵKŠ`Kvŷvi`Zwi eY°ŷj vi ŷviv GK mŷ½
t`Lv l ŵkŷv`, Avb` l Rŷbvi ZŷB.`B-B jvf nq| KvMR w`tq ev j ZivcZv, dŷj w`tq l
eY°ŷj vi ifc t`lqv hvq| GtZ cKŷZi mŵt_l ŵkit`i Nibó nlqvi mŷhvM NŷU|
tQŷj ŷgtqŷ`i tK eY°Abŷvqŷ mŷŷi mŷŷi Avkv-evkv fvte`va Kwi tq ev evntq GK GKuW eY°
ifcŷmZ Kiv hvq| tQŷj ŷgtqiv GtZ Avŷiv Avb` jvf Kite|

PvU° bgbv Qŷt` i ŷviv

(3) eo eo PvU°ŷuOb Qwei ŷviv ŵPŷ ŵeŷPŷŷZ Kti eY°cwiPq, cwiPZ ktã Avtj L` ifc,
cŷuLi ŵPŷvKIŲ Qwe, cŷuKŷZK`k` BZ`ŷŷi ŷviv tkŷŷKŷj Ggbfvte mivŷtZ nte hvŷZ
ŵkii`ŷP ŷŷi ŷk cŷq me mgŷqi Rb` Avkó.ti tL Zvŵ`i tKŠZnjx Kti tZŷtj | GB
ŵeŷPŷ`k`ifc ŵkŷv`i mŵt_ mŵt_ Zvŵ`i ŷŷi gtb Avb`i mÅvi Kite| GQovl nŷZi
tj Lvi KtqKŷu Av`k`bgbv PvU°_vKte| tmBme bgbv Qŷt` Zviv ŷj LŷZ AbŷŷŷZ nte|
ŵkii Abŷŷi Y ŷcŷZvi mŷhvM MŷY Kivi Rb` GB e`e`vi weŷkl cŷqvRb iŷtq|

GKuW c×uZi Dci AvŷiKuW c×uZi cŷve cŷqB t`Lv hvq| Avevi me c×uZiB ŵKQy
weŷkl mŷeav l μuŷ iŷtq| tm Rb` ŵelqe`i Dŷíŷk`i Dci ŵbfP Kite tKvb c×uZ
e`envi KitZ nte| GKRB ŵkŷtKi me c×uZ m×úŷK°avi Yv _vKŷj ŷZvb`ŷŷZi mŵt_
ŵkŷv`ŷŷi i gb-gvŷmKZvi ŵePvi Kti ŵelqe`Dc`vcb A_ev fvlv ŵkŷŷY Dchŷ c×uZ
Aej`b Kti mŷ`Ų fvte cvŷ`vb ev ŵkŷŷY Kvhpŷg m×úv`b KitZ cvŷeb|

ṽ Ae GW#Kkb

GQrov fvlv ṽKṽYi Avi I KZ, ṽv c×wZ AvtQ, th, ṽv we`ij tqi D`PZI tkYtZ tenk KihRix|

1. i × evbvb ṽKṽ
2. kĀZij uc
3. e`vKiY ṽKṽ
4. KweZv I Mṽ`i cv`vb
5. weZKṽmfvv AvtqvRb
6. e³Zv, cĀÜ, KweZv I Mí cvṽVi Avmi |

i × evbvb ṽKṽ: ṽ Lvq evbṽbi i ×Zv i ṽv fvlvi cwi "QbZvi Rṽb" GKvšl cĀqvRb| tm Rb" GKw Kwb evbṽbi kĀK evivi t`Lv, tkvbn, gṽL gṽL evbvb Kiv Ges meṽkṽl ṽ Lvq e`envi Kṽi GṽK AvqṽE AvbṽZ nṽ| ṽKṽK ṽKṽKṽ i j ṽ" nṽ hvṽZ QvĪ-QvĪxiv evbvb fṽ KṽZ bv cvṽi | tm Rb" AvṽM t`ṽKB hṽ_vchṽ mZKZv Ae j ṽb KṽZ nṽ| th mg`l kṽi evbvb tQṽ-tgṽqv fṽ KṽZ cvṽi, ceṽ_ṽKB Abṽvb Kṽi ṽKṽK tm me kṽi evbvb tevṽWṽj ṽL w`ṽeb Ges QvĪiv tm me kĀ, ṽjvi evbvb Zṽ`i wR LvZvq Zṽj wṽtq Zv AvqṽE Kṽe| tKvb GKw kṽi evbvb fṽ wj ṽL tdj ṽj ṽKṽK QvĪ-QvĪxṽK AšZ nek evi kĀw LvZvq wj LṽZ wṽ`R w`ṽeb|

kĀZij uc: kĀZij uci cĀvb Dṽl`k" nj QvĪ-QvĪxiv GKw cv`v i`ṽb kṽYi mṽ_ Zvj tiṽL KZ `ṽZ Zv wj ucex KṽZ cvṽi, Zv cixṽv Kiv| QvĪ-QvĪxiv thb evbvb fṽ Kivi AeKvṽ bv cvq G e`vcvṽi ṽKṽKṽi mRvM `wó_vKṽZ nṽ| kĀZij uci cv`vṽb AvṽiKw wṽtq j ṽ" ivLṽZ nṽ| wṽlq e`i wṽeṽb thb cv`cyK ev` wṽtq mṽwṽZ`i wṽLṽZ cyK, wj nṽZ wṽEvKlR I imṽjv tKvb GKw Ask ev AbṽQ` t`ṽK ṽb| qv nq Ges Gi wṽlq e`thb GKvṽṽi Z` Ges cĀZ Avb` we`sq cwi tekṽ KṽZ cvṽi |

e`vKiY ṽKṽ: AṽbK ṽKṽK gṽb Kṽb fvlv AvṽM, e`vKiY cṽi | ZvQrov ṽṽ Rṽeb nṽZ AṽbṽKṽ gṽb e`vKiY wṽfṽw Kv `vqx nṽtq AvṽQ| ṽKš' fvlvi e`enviK tṽṽṽ e`vKiṽYi , iṽZj Dcj wĀ Kṽi GB five `i Kiv `iKvi | KviY eZṽvb wĀvb I KwiiMwi ṽKṽvi cĀvṽb`i hṽM Ges Rṽṽbi ṽgeaṽvb RvĪj Zvi Rb" Avṽṽ`iṽK cĀZvbqZ bZb bZb kĀ %Zwi Ges e`envi KṽZ nṽ"Q| G tṽṽṽ e`vKiY cvṽVi cĀqvRbxqZv A`ṽKvi Kivi Dcvq ṽbB| Avṽṽi tṽṽṽ wĀvb thgb ms`vi ex gvṽṽi i mKj AÜ wṽkṽm I wṽšli A`úóZv `i Kṽi t`q, fvlvi tṽṽṽ e`vKiY wĀvṽṽi b`vq mKj Ai ×Zv I AccĀqvM `i Kṽi wṽtq Gi wṽi ×Zv I thšw³KZv i ṽv Kṽi | e`vKiY cvṽVi Avi GKU cĀvb Dṽl`k" nj tgṽj K iPbvṽkjx Mvb| e`vKiY mṽšZ Dcvṽq kĀ Mṽṽbi wṽqgvejx bv Rvbn_vKṽj wṽkó iPbvṽwzi AvṽKvix nṽ qv mṽeci nṽtq DṽV bv|

KweZv I Mṽ`i cv`: KweZvi mṽzcv` ev AvṽEi Dci KweZvi Avṽ`b I AvṽM mĀi GKvṽšl wṽfṽ Kṽi | ZvB i ayD`, hṽZ I wṽi wZi cĀ_wgK Avb_vKṽj B Pj ṽe bv, KweZvi

fve I Avʔem Avɔvʔi weʔkʌ weʔkʌ kʔai Dci tʔuk t`l qvi mnR fivʔuʌ AvqĒ KiʔZ nʔe| tʔm Rb` kʔai D`Pvi Y aʔvʔb mʔZ nʌ qv PʌB|

M` cvʔVi Dʔi`k` eyx i RvMi Y I cwi gvRʔ Ges vPʔi I gbbkxj Zvi `vʔB eʔx| tʔm Rb` Mʔ`i cvV`vʔb Z` I A_©mieivn Kiv nq, cʔkʔe ʔviv `jʔeʔ` fve I Rivj ZʔĒj weʔkʌ Y Ges Avʔj vPʌv ʔviv `jʔh mgm`vi mgravb I Avɔvʔvʔ Pʔj | GB Dʔi`k` gʔb tiʔL vʔKʔK Mʔ`i cvV`vʔbi cʔvʔZ vʔʔZ nq|

weZKʔmfvi AvʔqvRb: weZKʔ eʔZvi ʔviv ʔvĪ-ʔvĪvʔ`i vPʔi kʔvʔ evote, ʔvĪv cwi "ʔbʔe hʔvʔ I vPʔi mʔv` mʔv` Avcb Avcb K_v vʔQʔh ejvi kʔvʔ jʔvʔ Kiʔe Ges cvʔVi ʔviv bʌvʔ Z` I ZĒj msMʔni Rb` Zviv Avʌ AvMʔx I Drmʌvnx nʔq DVʔe| eʔZvi, cʔĒ, KweZv I Mʌ cvʔVi Avmʔi i mʔy i evPʌb fivʔ I evKʔvʔ i DrKʌ vʔvʔ mʔe|

iPʌv vj LʔZ t`l qvi ga` vʔʔqʌ ʔvĪvʔ`i fivʔvq `ʔZvi evovʔb vʔe| Kvi Y iPʌv vʔKʔvʔvʔbi cʔvʔb j`ʔv` nʔe ʔvĪ-ʔvĪvʔ`i vPʔi kʔvʔʔK RvMʔZ Kʔi fve-fivevʔ I gʔbi K_v vʔB`^fivʔʔZ cʔvʔk mʌvʔh` Kiv|

cvʔVvĒi gj`vqb: 4.3



A) msvʔvʔ DĒi gj`K cʔkʔe

1. vʔKʔvʔ`vʔ cʔvʔZ I tʔKʔkj ej ʔZ vʔK eʔvʔq?
2. vʔKʔK tʔKʔ`K I vʔKʔvʔ`xʔKʔvʔ`K cʔvʔZ KʔvʔK etj?
3. fivʔv vʔKʔvʔYi evK` cʔvʔZ mʔvʔvʔKʔavi Yv vʔb|
4. tʔcʔI ʔq tʔg_W vʔK?
5. n`vʔvʔi vʔKʔvʔvʔbi cʔvʔZvʔU vʔKiʔc?
6. evKʌ Y vʔKʔvʔ`vʔbi cʔvʔvʔRʔvʔqZv vʔK?

cVmvGMö cÛqb [Text Material Writing]

fvgKv

cVmvGMö (Text Material) ej tZ Avgiv ejs vj uLZ ev gvZ tKvb cVbthvM" mvgMöK/ tmUv nZZ cvti tKvb cv"cyK (Textbook), tgsjij K iPbv (Text/Discourse), cvl Kvq cKvukZ udPvi, MtelYv cti cü BZ"v | tckvMZ ev mRbkxj KvR cÜq mgqB Avgiv`i G mg`cVmvGMö vj LtZ ev cÛqb KitZ nq| wekIZ, Ktj R ev `ç chiqi uk¶Kt`i cÜZ eQi AšZ Ktj R/`ç g`vMvRb,tjvi m`uv`bvi `vqZj vbtZ nq| tm¶¶t, m`uv`bvi tKškj, cüv vWv BZ"v m`utK`RvbtZ nq|

G Aa`itq Avgiv weifbacKvi cVmvGMö cÛqtbv tKškj MZ v`K vbtq Avtj vPbv Kitv| G Aa`itqi cv, tj vtK vbtgv³ fite mvrvtbv ntqtQ|

cV- 5.1: cv"cyK cÛqb I gj`vqb

cV- 5.2: M" iPbv

cV- 5.3: udPvi cÛqb

cV- 5.4: m`uv`bv

cW 5.1

cW`cŷK cŵqb I gj`iqb

Dʔík`

GB cW tktl Avcib—

- cW`cŷK cŵqʔbi , iaz;e`vL`v KiʔZ cviʔeb;
- cW`cŷK cŵqb cwi Kí br I Gi wefbaavc eYᅡv KiʔZ cviʔeb;
- cW`cŷK i`enkó` eYᅡv KiʔZ cviʔeb;
- cW`cŷK i Pbvbnz eYᅡv KiʔZ cviʔeb;
- cW`cŷK i cŵqʔb mc cŵqʔb tKškj eYᅡv KiʔZ cviʔeb Ges
- cW`cŷK gj`iqb I Povš|cŵqʔb mc cŵqʔb tKškj eYᅡv KiʔZ cviʔeb|

cW`cŷK i az;

ukŕivμg (Curriculum), cW`mπ (Syllabus) I cW`cŷK (Textbook) GKB mʔ MĊ_Z ukŕiv cĉqvī wefbaavc | Gi gʔa` cW`cŷK ukŕiv-ukŕiv_ʔ cW`vb I cW`mĉʔbi meʔPʔq , iazcʔDcKiY | Kvhŕi ukLʔb ukŕivmniqK DcKiY wntmte cW`cŷK i az; Acwi mxg |

cW`cŷK tKB A`veia mri vekt; ukŕiv`vʔbi cĉvb DcKiY wntmte e`envi Kiv nʔq _vʔK | G KviʔY ukŕivμg, cW`mπ Z_v ukŕiv j`ŕ` I Dʔík` mraʔb cW`cŷK cŵqb GKūU , iazcʔveᅡq | Ávʔbi th tKvb veᅡq vbʔq, th tKvb fiv v fivʔZ GKūU maviY cŷK cŵvZ nʔZ cvi | ukš; cW`cŷK Zv t_ʔK mʔúYᅡv v`v | GKūU cW`cŷK cŵqʔb _vʔK vbv`ᅡ j`ŕ` I Dʔík`, cwi Kí br, bnzgvjv mteŕcwi mhZemZŕ cĉvm | tKbbv, cW`cŷK i YMZgvb i ŕv GKūU , iazcʔveᅡ K |

cW`cŷK cŵqb

GKūU maviY Mš' GKRB e`iᅡi B`Qv, Awfjvl ev cwi Kí br Ablyqx cŵvZ nʔZ cvi | ukš' cW`cŷK GKūU RvnzʔMvôxi ukŕiv`kᅡ cĉZdij Z nq | Gi mʔ_ ukŕivμg (Curriculum) I cW`mπi (Syllabus) AvAvz mʔúK`iʔqʔQ | th KviʔY GKūU cW`cŷK cŵqʔbi tŕʔt iʔqʔQ ukQyarc | G avc , tjv tgvUvgnj mKj t`k I Rvnz tgvb Pʔj |

⊘ Ae GWKkb

⊘tgGkqv gnvt`tki 3u t`tki cv̄c̄yK c̄q̄tbi avcmgn Ztj aiv ntjv|

tkwiqvi cv̄c̄K c̄q̄tbi avcmign

cwi Kí bv



⊘k¶vμg m⊘v`⊘KiY



Dch̄y ⊘kLb AvfÁZv ⊘be⊘b I ⊘eb`vm



Lmōv cv̄Uḡ ⊘c i Pbv



cv̄Uḡ ⊘c c̄K-gj`vqb



cwi gvR⊘



ḡyY

⊘Bj`t̄Ūi cv̄c̄K c̄q̄tbi avcmign

cwi Kí bv



c⊘vj Z cv̄c̄K ⊘ētkiY



Lmōv cv̄Uḡ ⊘c i Pbv



Dc̄th̄vM̄Zv gj`vqb



cwi gvR⊘



ḡyY



⊘eZiY

tbctj i cv̄c̄K c̄q̄tbi avcmign

GWKkb tgŪvi q̄j tm>Ūvi t̄K cv̄c̄K̄tki cv̄Uḡ ⊘c c̄q̄tbi ⊘t`R`vb



m̄t̄ēf̄Ēg cv̄Uḡ ⊘c ⊘be⊘b



ḡyY



⊘eZiY Í ev̄`evqb

G c̄h̄t̄½ eisj vt`k D>ḡy ⊘ek̄⊘e`vj t̄qi cv̄c̄yK c̄q̄tbi avcmgn GK̄u t̄dv-Pv̄t̄ŪP gva`tg t`Lv̄bv th̄Z cv̄i | (⊘P̄T̄u evD̄⊘e c̄K̄⊘kZ ūcv̄vm̄gM̄ c̄q̄b e`en̄vi K̄v̄ c̄ȳK̄v t`t̄K t̄bl q̄v nt̄q̄t̄0) |

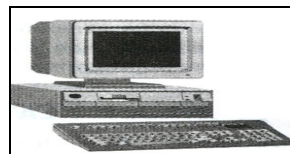
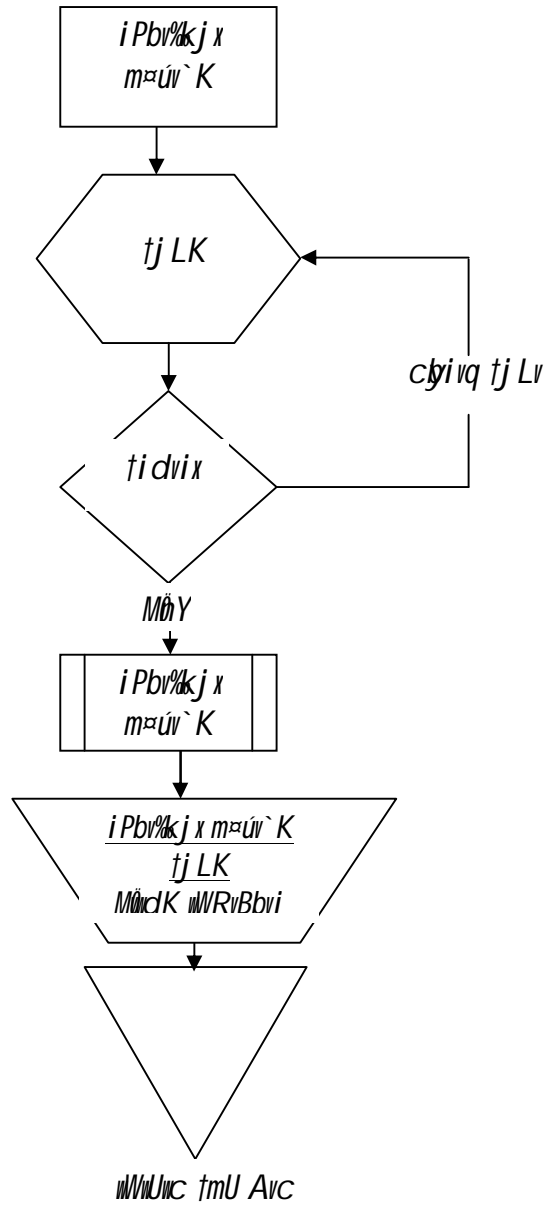

«PÎ 5-1.1: evDneŷi cvVmgMŷ cŷqŷbi avcmgr/

ciV'cŷġKi ėikó

ciV'cŷġ cġqtb ġKQy, iazġYġġ K ġetePbvq ivLġZ nq| AvšRmZġ ġġġv cwiKġbv
BŷġġUDU, c'imi m, ciV'cŷġ cġqtb th ġ K, ġġvi Dci, iazġAvġvc KġġQ Zv ntġv:

- mġWK, ġei x I ġbLġ Z' cwiġekb- ciV'cŷġK cwiġekZ Z' mġúġZK I ġbfġ
ntZ nġe|
- AfšġġY Kvġġġvi avivemK ġeb'ġm- ġelqē' cwiġektb mġġġ ġ chġġġg iġġv
KġġZ nġe| mġaviYfġġe mġR t_ġK KġWb, gZ'ġ_ġK ġegZ'ġA_ev ġetkl t_ġK
ġġġġKl- G mKġ bġġZ AbġġiY Kġġ ġelqē'ġ ġeb'ġm Kiv nq|
- ē'envi thġM'Zġ- ġġġġ_ġ ciV'cŷġK mġġR ē'envi KġġZ cvġġe| G ē'envi nġe
Avġvg`vqK|
- ġúZv I A_ēYZġ- ġelqē'ġ ġġġZv I ġġevaZv cwiġvi KġġZ ġġġġ_ġK th Avb
I ġġZv ġġZ PġB Zvi cġZdj b_vKġe ciV'cŷġK|
- ġġġġ_ġ Pġġġ`v I Avkv AvKvLvi cġZdj b- ciV'cŷġK cwiġekZ ġelq ġġġġ_ġ
Pġġġ`vi cġZdj b Nġġġe| ġġġġ_ġ cwiġġġ GġZ ġetkl ġ iazġġvf Kġġe|
- ġġZKġ I AcġġqvRbxq ġelqē'ġ cwiġvi- ciV'cŷġK AcġġqvRbxq ġelqē'ġ_vKġebv|
ġġZK I agġġ tēġġ AvġvZ_vKġZ cvġġi Gġfc ġelq eRġ KġġZ nġe|

ciV'cŷġKi iPbviġZ

ciV'cŷġ iPbvi tġġġġ mġaviY ġKQyDc'ġmZ iPbviġZ Aeġġb Kiv nq| eZġġtb
ciV'cŷġ iPbvq cġvYZ ġġġ iġZ AbġġZ nġ'Q, h_v-

- mij iġZ
- gWġġ vi iġZ

mij iġZġZ ciV'cŷġKi ciV' ġelqē'ġmġ mij t_ġK KġWb G ġġgAbġġġġ ġeġfbġAa'ġġq
fġM Kġġ cwiġekb Kiv nq| GġZ cvġVi ġelq Dc'ġcb Kiv nq mġvġvi fġġe| cvġVi
Dġġk' A_ev ġġġ'vqġbi tKġb ē'ē'v_vġK bv| GġZ ġġġġ_ġ ġġLġb DrmġġZ nq bv|
cġġġK I ġbgġġv'ġġK ġġi ciV'cŷġK iPbvq G iġZ AġġK Dc'thġġġ|

gWġġ vi iġZġZ ciV'cŷġKi ġelqē'ġK fġeMZ HġK'ġ ġ K t_ġK KġqKġġ BDġbġU fġM
Kiv nq| cġZġġ BDġbUġK ġZb t_ġK 5ġġ fġġM fġM Kiv nq| cġZġġ BDġbU mġRġġbv nq
Gfġġe-

- fġġKv
- ciV'ġefvRb
- Pġvšġġġ'vqġ|

BDġbġUi ciV'mġġġ_vġK-

- cvġVi ġġġivbġ
- cvġV ġġġġ_ġ AvPġYxq Dġġk'
- ġelqē'ġ eYġġv, ē'vL'v I ġetklġY
- cvġViġi ġġġ'vqġ|

፲፭ Ae GW፳Kkb

- *welq wetklÁ*
- *tkñY wk¶K*
- *wk¶K cñk¶K*
- *wk¶vµg wetklÁ*
- *Bj v†÷Ui |*

G wetklÁ `tj i cĔ`¶ ZĔpav†b civŪ¶ mc msMñni ci G, tj v†K m‡úv`bvi e`e`v Kiv nq| m‡úv`bvi Kv†R mivaviYZ `ጴi†bi m‡úv`K _v†Kb| h_v:

- 1. tidvix m‡úv`K*
- 2. `k j x m‡úv`K |*

tidvix m‡úv`K ntj b welq wetklÁ| wZwb welqe`i h_፱ Zv, wbfጾ Zv, I miv‡úv`ZKZv civ¶v K†b| G Qvon wZwb civŪ¶ wciw wk¶v_¶ Rb` Dc†hwm Mx wkbv, G wetq gZvgZ cñwb K†b| tidvivi gZvg†Zi Av†j v†K tjLK wetqe`i cñqvRbxq mstkrab K†b| `k j x m‡úv`K wetqe`i KvV†gvmZ web`v†m fvgKv iv†Lb| wZwb civ`cyKwUi wP†vqb, Kv‡úvDuvivqb I gÿY wetq cñqvRbxq fvgKv cij b K†b|

gj`vqb

civ`cyK iPbvi ci t`ke`mc e`env†ii Av†M Zvi Dc†hwmZv gj`vqb Ki†Z nq| G igj`vqb `ጴch¶q n†q _v†K| h_v:

- 1. tkñYK†¶ gj`vqb*
- 2. hÿ፵m× gj`vqb |*

1. tkñV K†¶ gj`vqb

civ`cyK iPbvi ci e`env†ii Av†M wbu`፳ msL`K wk¶v_¶ Dci Zv cñqvM K†i Dc†hwmZv gj`vqb Ki†Z nq| G Dc†hwmZv gj`vq†b wZbw avc itq†Q h_v- bgvv gj`vqb, cñi‡K gj`vqb I gvV ch¶q gj`vqb| bgvv gj`vq†b `yGKuW tkñY†Z civ`cyKwU†K cñqvM K†i gj`vqb Kiv nq| Zvi ci cñi‡K gj`vq†b Av†v Av†K msL`K tkñY†Z cñqvM Kiv nq| gvV ch¶qi gj`vq†b `xN¶mgq a†i e`vcK wfvĔ†Z e`envi K†i civ`cyKwUi Dc†hwmZv wY፱ Kiv nq| Gi cñZw ch¶q ch¶e¶¶Y I wk¶v_¶ KwZZ; Afv¶v (Achievement Test) Mñ†Yi gva`†g Z_` MñY Kiv nq|

cW 5.2

M` iPbv

Dt`k`

GB cW tk`l Avcub—

- M` I M`i`i newfbæifc m`útk`ej tZ cvi`eb;
- cêÜi iPbv c`wZ eY`v Ki tZ cvi`eb;
- tQvU M`i`i `tfc I `enkó` e`vL`v Ki tZ cvi`eb Ges
- Dcb`v`mi `tfc I `enkó` ,tjv eY`v Ki tZ cvi`eb|

thvM`thv`Mi gva`g wntmte fvlv Awie`v`i ci, a`i tblqv h`vq, gvby `b`b R`xetb M``KB e`envi K`i`tQ| Z`wvc, GuU GKvU we`sqKi w`elq GKgv`Rvcvbx m`v`vZ`i K`_v e`v` w`tj c`w`exi c`lq m`Kj m`v`vZ`i Av` w`b`k`B wntmte K`weZv`KB cvlqv tM`tQ| G`t`q`i` M`` A`tc`q`v`KZ.AeP`xb| w`etklZ, evsjv m`v`vZ`i M``i`i m`Pbv Av`v`v`v kZ`tKi tk`l`v`ta`q Gi Av`tMi M`` c`v`vZ w`Pw`c`T, `w`j ` `t`et`Ri M``; w`bZv`S`B Ac`wi`YZ|

Z`_, h`y`p, `Avb I fve c`Kv`tki t`q`i` M``i`i w`ek`i` tbB| t`m` Rb` M``i`i i`t`q`tQ w`e`P`i`f`ci c`Kv`k| cêÜ, w`beÜ, M`i, Dcb`v`m, ig`i`Pbv, w`Pw`c`T, m`sev`c`t`i` K`j`v`g Gme`_tj`v`B M``i`i newfbæifci c`Kv`k| G cv`v` M``-i`Pbv`i me`_tj`v` i`f`ci Av`tj`v`Pbv`i AeK`v`k` tbB| Av`g`iv` M``i`Pbv`i c`v`v` w`Z`v`U` i`f`c, h`_v- cêÜ, tQvU M`i I Dcb`v`m w`b`t`q Av`tj`v`Pbv`i Ki`t`ev`|

cêÜ

ûcêÜû k`w`U`K B`st`i`R`x`Z` Essay ejv nq| cêÜ RvZxq iPbv`K B`st`i`w`R` Essay, Treatise, Discourse, Dissertation ejv nq| w`K`S`' Essay ej tZ w`etkl`-RvZxq iPbv`tev`Sv`q| B`st`i`w`R` Essay k`t`a`i` evsjv c`l`Z`k`a` wntmte ûcêÜû k`w`U`i e`envi t`L`v` h`v`q| Essay k`w`U`i g`j`-M`Z` A`_`q`c`q`v`m`l`| G`t`Z` t`j`L`t`Ki` e`w`³`M`Z` w`e`P`v`i`e`y`x` I g`t`b`v`f`w`z`i` h`_v`_` w`g`j`b` N`t`U`| Z`v`B` G` a`i`t`b`i` m`v`v`v`Z`i` m`j`o`i` gva`t`g` Z`_` I` Z`t`E`j`i` m`g`v`t`e`k` t`j`L`t`Ki` t`h` e`w`³`M`Z` f`v`e`k`Z`v` i`f`c`v`w`q`Z` nq` Z`v` cv`v`t`Ki` g`t`b` m`n`t`R`B` Av`t`j`v`o`t`b`i` m`j`o` K`t`i`| w`b`t`R`t`K` c`K`v`k` K`i`v`i` Rb` t`h` w`e`k`o` f`w`z` e`v` ÷`v`B`j` M`h`Y` K`t`i`b` Z`v` cv`v`t`Ki` g`t`b` m`v`o`v` R`v`M`v`q| Gme` `e`w`k`o`i` c`w`i`t`c`q`i` tZ` evsjv ûcêÜû K`_w`U` B`st`i`w`R` Essay k`w`U`i` m`g`c`h`q`f`z` e`t`j` w`e`t`e`P`bv`i` t`h`v`M`|

cêÜ ej tZ tKv` w`elq`e`-` Aej` t`b` i`w`PZ` t`j`L`t`Ki` e`y`x`e`w`E`g`j`-K` M``i`w`Z`i` GK` a`i`t`b`i` m`v`v`v`Z`i` m`j`o`i` t`ev`Sv`q`| w`elq`e`-` m`g`z`m`-û`h`y`p` a`v`i`v`e`v`v`v`K` c`v`i``u`h``m`n`t`h`v`t`M` w`etkl` Av`t`j`v`Pbv`t`K` cêÜ` b`v`t`g` w`P`w`y`Z` K`i`v` h`v`q`| `Avb`-w`e`Á`v`b, `k`B`-B`w`Z`v`m, m`g`v`R`-i`v`R`b`w`Z, m`v`v`v`Z`i`-w`k`i` K`j`v` c`f`w`Z` w`elq` w`b`t`q` t`h`m`e` Z`E`j`K`w` `K` I` e`-M`Z` w`P`S`i`g`j`-K` M`` w`beÜ` i`w`PZ` nq` Z`v`t`K` ejv` t`h`t`Z` c`v`t`i` cêÜ` m`v`v`v`Z`i`| m`v`v`v`Z`i` Ac`i`v`c`i` k`v`L`v`i` g`Z` cêÜ`I` m`v`v`v`Z`i` wntmte w`e`t`e`P`| G` a`i`t`b`i` m`v`v`v`Z`i` m`j`o`i` tZ` h`y`p`i` m`v`v`v`t`h` t`K`v`b` e`³`e` c`K`v`k` K`t`i` Z`v`t`Z` t`j`L`K`t`K` m`v`v`v`Z`i` t`m`i` m`Á`v`i` K`i`t`Z` nq`| G` Rb` cêÜ` iPbv`i` g`t`a` t`j`L`t`Ki` e`w`³`M`Z` t`L`q`j`L`y`k` c`K`v`t`ki` t`K`v`b` m`t`h`v`M` t`b`B`| c`l`Z`K` cêÜ` t`K`v`b` w`K`O`y`c`l`Z`c`v` `w`elq`_v`t`K`| h`_v`_`Z`_` c`l`v`t`Y`i` m`g`v`t`e`k`,

fite, fvlvq, wPšli cŕqvM tmB cŕZcv` melqtK ifc`vb KivB cŕtŭi j 97| mvari Y Kíbr I eyxewEi Avktq Kti tj LK hLb tKvb melq m=útK©AvZm†PZb bwiZ`xN© mvinZ`ifc mwó Ktib ZLb Zv cŕŭ wntmte AvL`vqZ nq|

cŕŭ iPbv

ŕcŕŭŕ kŕwI A_ŕj cKŕi,fc eŭb| -GB eŭb fitei eŭb, wPšli eŭb, fvlvi eŭb| fve I fvlvi cKŕ. eŭtb Avex iPbv†K cŕŭ bvtg AwfwnZ Kiv hvq| mvari Yfite iPbv ej †Z tKvb wKŕj wbgvř Kiv tevsvq| wbgvř ev MV†bi tej vq wbgvřKvi†K mshZ, thšw³K I m†PZb tPŕv t`Lv†Z nq| cŕŭ iPbvi t97†I Ggb `enkŕŕ` weivRgvb _vKvi we†kl cŕqvRbxqZv itqtŕ| ZvB fitei m½wZ, wPšli cvi=úh© Av†j vPbvi thšw³KZv, eYŕvi mshg I k;Ljv, fvlvi `úŕZv ev FRžv, tmš`h©I tmšKh©Ges iPbv†Kjx ev ŕvB†j i jvuj Z` I cŕv`_Y mh†Zæi 97v Kti th tKvb melq wbtq we`Z. A_P cvi wqZ Av†j vPbv wj wce x Kiv†K cŕŭ iPbv ej v P†j |

tj L†Ki evB†ii RMr t_†K cŕqvRbxq Z` Pqb Kti, cvi Kwí Z Dcv†q mvr†q, Z†K g†bi i†m w³ Kti w†Ri evPbfw½gvi Abv†i†Y ifcgq Ktib| evB†ii melq I wPšl-fvebv msMŕ Kti, Aš†ii fitei Hk†hř `gvi Ltj, Z†K ũ`qMŕx fvlvq e`³ Ki†Z cvi†j cŕŭ h_v_B wí n†q D†V|

cŕŭ ej†Z tKej fitei A`g` D`Pvm bq, G†j v†g†jv wPšli wenej Zv bq ev ktŕi Avŕ†i SsKvi I bq| cŕtŭi Rb` `iKvi fitei D`ŕj Zvi wbgšY, `iKvi wPšli hvř-k;Luj Z cvi=úh© `iKvi fvlvi GKŭv Rxešifc- hv†K ejv th†Z cvi mžzcwi†ekbv| Avmj K_v, cŕŭ iPbvi tejvq fve†K mshZ A_P Zxe†Kti Z†Z n†e, hvř k;Ljvi ŕviv Z†K kvmb Ki†Z n†e Ges GKŭ cŕYešl fvlvi mvr†h` Z†K mŕi, wí`_YgŭŭZ I ũ`q`úkr©Kti Z†Z n†e| cŕŭ KZ cvi wvY wPšli m†½ fvlvi KZ cvi wvY wí ifc cvi†ekZ n†e Ges Zv wKfite ũ`q`úkr©Kti Z†Z n†e, Zv wbfř Kti tj L†Ki cvi wqZ†ev†ai Dci| tmRb` iev`bv_ VvKž etj†ŕb, ŕiPbv ewj†Z tm†j fitei mvinZ fve cKv†ki Dcvq `B mvr†j Zfite tevsvq; wKš`we†kl Kwí qv DcvqŭvB tj L†Ki |ŕ

cŕtŭi tkYwefM

cŕŭ†K cŕvbZ `B tkŕv†Z wF³ Kiv hvq:

1. Zb†q ev e`wbŕ cŕŭ Ges
2. gb†q ev e`w³MZ cŕŭ|

welqe`i cŕvb` `xKvi Kti thme cŕŭ i wPZ nq, tm_†j v†K e`wbŕ cŕŭ ejv nq| G ai†Yi cŕtŭ tKvb mŕw`ŕ mŕg†i Lvi g†a` Avr, ga` I Ašl m=ŕj Z wPšl cŕvb mwŕ| G†Z tj L†Ki cimŭZ` I Av†bi cvi PqB cŕvb fite cKvk cvq| tj L†Ki Av†bi cvi wa ev Abb`mvari Y wPšl†kxj Zv GB tkŕvi cŕtŭ ifc wqZ nq|

th me cŕtŭ tj L†Ki e`w³ ũ`qB cŕvb n†q t`Lv t`q, tm_†j v†K e`w³MZ cŕŭ ejv nq| G_†jv Av†bi melqtK j NyKí bvcŕŕB Kti n†m`v†4j ifc cvVK†K gy Kti | e`wbŕ cŕtŭ tj L†Ki wPvi eyx I wPšl†kxj Zv cŕvb; e`w³MZ cŕtŭ tj L†Ki Abv†Z wŕ mi j

ḡ Ae GWKkb

nvm'gay AvZēúk³cāvb; e⁻nbō cēū tj LK mbtRtK cvtKi KvQ cōZwōZ Ktib, e³ir³MZ cēū tj LK cvtKi mvt_ Awfbantq GKvšl AvcbRtbi gZ Avcbvi K_vu etj hvb|

e⁻nbō cēūB mavi YZ cēū bvtg cwi iPZ| GB tkvYi cēū vtK e⁻ev weltaqi cwi Pq, gZ wētkl i cKvk, iPšl³i Awfe³ Ges h_vthvM³ fvlvÁvb| G mg⁻l iPbvq m³mwZ³K cōZfvi tPtq Zxyētevak³iB teuk cwi Pq w⁻tZ nq|

cēūi iPbv³xwZ

cēū iPbvKvtj h_vthvM³ DcKtYi msMh Ges Zv Dch³ fvlvi gva'tg cKvtki w⁻tK j³ i⁻ivL³Z nq| e⁻i GB wewa⁻ewktō³i my³i wj³b NUtj B Zv m⁻R cēūi tMSie jvf Kite| GB Df³k³ mva³bi Rb³ KZK³, tj³ v c³xwZ Aby³i Y Kivi cōqvRbxqZv i³tq³| c³xwZ³, tj³ v wgb³fc:

1. **wbe³PZ cēūi fviemsMh** metPtq³, i³z³c³Y³KvR| cēū tj LtKi th weltaq h_v³ Ávb AvtQ tZgb weltaqB ZvtK wbe³Pb Kti wbtZ nte| cēūi m³ú³K³ ai³Yi e³e⁻ i³fcwqZ Kti Zj³tZ nte Zv i³Pšl³ mnKvti msMh Kiv⁻ i Kvi | gtb i³ivL³Z nte th, th weltaq hvi tKvb Ávb ev AwfÁZv tbB Zv Ae³ w³tb cēū iPbvi tPóv Kiv w³o³bv g³l | cēū iPbvi tejvq Mí Dcb³im KweZvi gZ Kí³bvi tKvb AeKvk tbB| ZvB iPbv Avi³ Kivi c³te³wel qe⁻ m³ú³K³ GKUv⁻ úó avi Yv cōqvRb|
2. **e³e⁻ weltaqK m³y³zifc cKvk Kiv** cēū iPbvi Ab³ GKUw cōqvRbxq w⁻K| cēūi Rb³ i³ay³ve msMh Kitj B Pj³te bv, tm³, tj³ vi³, i³z³i³wetaPbvq cici m³RvtZ nte| Dch³ w³eb³v³mi gva'tgB tKej m⁻R cēū i³PZ n³Z cvti | m³k³:Lj³ frte e³e⁻ weltaqK cKvk KitZ bv cvitj Zv cvtKi w³KU mg³v³ Z n³Z cvti bv| GK GKUw m³F³ w³ē³.Kti GK GKUw Aby³Q⁻ iPbv KitZ nte| GK GKUw Aby³Q⁻ GK GKUw m³F³B i³fcwqZ nte Ges ZvtZ thb KLB B GKB K⁻vi c³ji³ w³ bv NtU|
3. **cēūi mPbv I Dcmsnvi** iPbvi w⁻tKl j³ i⁻ivL³Z nte| cēūi Avi³ ev mPbv m³y³vi Kwí Z n³Z nte| mgMō cēūi GKUv tgvUv³ Avf³im mPbvq cKvk c³te| Dcmsnvi I m³y³š³Z n³l qv⁻ i Kvi | Dcmsnvi³ Ggb n³Z nte hv³tZ cēūi mg³v³bi mvt⁻ mvt⁻ cvtKi gtb cēūi e³e⁻ m³ú³K³ GKUw cwi c³Y³avi Yv Rb³vq|
4. **cēūi fvlv iPbv³xwZ** w⁻tkl³, i³z³c³Y³ K| cēūi fvlv mnR I mij nte| e³e⁻ hv³tZ m³y³úó³ frte cKvk cvq tm iKg mnR fvlv e⁻envi KitZ nte| m³U³h³ Kev mg³ime³ x⁻ t³eva³kāvej x, Ac³vi i³PZ ev Ac³ij Z kā, kā³Z gva³h³ x³ kā ev RiUj³ evK³ e⁻envi Kiv Aby³PZ| evM³v³at³ ev AjsKvti³ evú³j³ e⁻envi Aek³B eR³bxq| m³mwZ³ i³mw³kZ³ m³ej³xj I cōÁj fvlvi³xwZi gva'tgB fvlvi c³h³v⁻ Y m³úó Kiv Ptj | G³w³ tK cēūKv³itK w⁻tkl j³ i⁻ivL³Z nte| weltaq⁻ i ZviZg³ Aby³v³ti cēūi fvlv I f³w³ w³ba³Y³ KitZ nte| i³z³c³Y³ weltaq ntj³, i³aw³ti Ges nij Kv weltaq ntj tm Aby³v³ti nij Kv X³t³Oi fvlvi³xwZi e⁻envi Kiv⁻ i Kvi | cēūi me³ GK B ai³bi fvlvi³xwZ⁻ v³Kte A³ tKv⁻vl m³vaj³xwZ Avi tKv⁻vl Pj³ w³Zi³xwZi w³g³Y³ bv NiU³tq, nq me³ m³vaj³xwZ, bv nq me³ Pj³ w³Zi³ e⁻envi KitZ nte| Df³q i³xwZi w³g³Y³ t⁻Y³xq|

ᶒ Ae GWKkb

- tQvU Mí eYᶒvagrᶒbq, eÄbvagrᶒ
- tQvU Mí Kvi Rxeᶒbi mvgvMᶒK w`K bq, tKvb GKvU weᶒkl w`K Zᶒj aᶒib|
- tQvU Mí Rxeᶒbi Lᶒvsᶒki Dc`vcbv_vᶒK|
- tQvU Mí Kvnbx RvUj Zv I eüPwiᶒᶒi mgvᶒtek_vᶒK bv|
- mgMᶒtQvU Mí GKvU gvᶒ five cwi ᶒᶒ nᶒq DᶒV|
- tQvU Mí tKvb PwiᶒᶒMZ ev gb`wᶒEK w`K Zᶒj aiv nq|
- tQvU Mí i fvlv nq mᶒsnZ, cᶒÄj |
- Abrek`K eYᶒv tQvU Mí_vᶒK bv|
- tQvU Mí i cᶒi ᶒᶒ cᶒv I mgvᶒᶒZ_vᶒK mᶒsex, `ᶒZMvZ, bvUKvqZv|

Dcb`vm

BᶒiᶒR ᶒNovelᶒ kᶒvU GᶒmᶒQ j`vUᶒb kᶒ Novellus t`ᶒK- hvi A_ᶒbZᶒ Mí ev Dcb`vm| tj LᶒKi Rxeᶒexᶒv hLb tKvb ev`é Kvnbx Aeᶒ ᶒᶒb ev KviᶒvKZvi Avᶒᶒq eYᶒvZᶒK w`K KᶒᶒᶒiᶒcᶒvqZ nq ZLb ZvᶒK Dcb`vm ejv nq| Dcb`vm gvᶒᶒi Rxeᶒbi cᶒᶒᶒᶒ iᶒcᶒvqᶒ_vᶒK| mgvR, mgq I Zvi cwi cᶒᶒᶒi tᶒᶒᶒᶒZ gvᶒᶒi Rxeᶒbi tKvb weᶒkl exᶒᶒY Dcb`vm iᶒcᶒvqZ nq| Dcb`vm Mᶒo DᶒV tKvb cwi Kvi Z Kvnbx Kvᶒᶒgv ev PwiᶒᶒK w`Nᶒi | Gi tᶒZi w`ᶒqB tj LᶒKi eᶒe` aiv Y Kᶒi | Dcb`vᶒmi mᶒvi Y `eᶒkᶒ`_tj v wᶒᶒᶒZᶒj aiv nj -

- Dcb`vm eYᶒvgj-K w`K Kgᶒ
- Dcb`vm Rxeᶒbi mgMᶒᶒc iᶒcᶒvqZ nq|
- Rxeᶒ I RMr mᶒᶒᶒᶒᶒᶒ LᶒKi AbyᶒZ, `kᶒ Dcb`vm iᶒc j vᶒ Kᶒi |
- Dcb`vm Kvnbx Pwiᶒᶒ I cwi tᶒᶒᶒᶒZ wᶒᶒq MvZ nq|
- Dcb`vᶒmi Kvnbx Kvᶒᶒgv hᶒᶒᶒᶒᶒᶒ I Kvj vᶒᶒᶒᶒᶒᶒᶒᶒ Mᶒo DᶒV|
- mPbv cᶒv I cwi YvZ Dcb`vm Kvᶒᶒvi Y mᶒᶒ Avex_vᶒK|
- Dcb`vm ev`éZv cᶒZdᶒj Z nq|
- Dcb`vᶒmi fvlv w`l qvᶒᶒᶒᶒᶒ nᶒq_vᶒK I
- Dcb`vm cᶒvᶒZ M`ᶒ` gva`ᶒᶒ tj Lv nᶒq_vᶒK|

M`ᶒ mᶒᶒᶒᶒᶒᶒᶒᶒ G kvLv_tj v Qvovl w`Pᶒᶒᶒᶒᶒᶒ e`eüZ nq| Aek`, mᶒᶒᶒᶒᶒᶒᶒᶒ M`ᶒ I c`ᶒ` iᶒᶒᶒᶒᶒᶒ cᶒ`ᶒ` wᶒᶒᶒᶒᶒᶒ kᶒᶒᶒᶒᶒᶒ w`Zᶒᶒᶒᶒᶒ mPbv nᶒᶒᶒᶒᶒᶒ| Z_vᶒc M`ᶒ mᶒᶒᶒᶒᶒᶒᶒᶒ `ᶒᶒᶒᶒᶒᶒᶒ Kᶒᶒᶒᶒᶒᶒᶒ fvlvq j`ᶒᶒᶒᶒᶒᶒᶒ e`eüZ nᶒᶒᶒᶒᶒᶒᶒ|



ὁμιλία ἐπιτομῆς: 5.2

A) ἐπιτομὴ τῆς ΔΕΙ

1. Πότε ἡ ἐπιτομὴ γίνεται ἢ τίς ἐστὶν ἡ ἐπιτομὴ;
2. πότε ἐξέρχεται ἡ ἐπιτομὴ ἐξ ὑποκομῆς ἢ ἐξ ἄλλου;
3. τίς ἐστὶν ἡ ἐπιτομὴ ἡ ἀναφορὴ τῆς ἐπιτομῆς;
4. τίς ἐστὶν ἡ ἐπιτομὴ ἡ ἀναφορὴ τῆς ἐπιτομῆς ἐξ ὑποκομῆς ἢ ἐξ ἄλλου;

cW 5.3

ԻՎՔԻ ԸՂԳԲ

ԺՒՐՆԱ

GB cW tkłI Avcb—

- իՎՔԻ ԻK Zv ej tZ cvi tēb;
- իՎՔԻ i i nel qe փ eYԹv Ki tZ cvi tēb;
- նեմբաճԻկ իՎՔԻ մասնակցությամբ լեզուի ցուցանման համարձակությունները:
- իՎՔԻ i Pbv tkŠkj e՛vL՛v Ki tZ cvi tēb|

ԻՎՔԻ

ԻՎՔԻ (Feature) ej tZ Avgiv msev`cĪ ev mivgucKtZ cĪKvKZ gvbnEK Avte`b mgx i PbvK evS| hı I kãU eũgmĪ K A t_ e`envi Kiv nq| thgb, fiv neAvtb aYub ZvĪEK cıı Pq A t_ Phonetic Feature, cY% N°Pj ԻՄՒՒԻՒԻ Feature Film ej v n t q _v t K| ԻKŠ msev`cĪ, mivgucKtZ eZԹv b նեմբաճ ԻՎՔԻ i PbvK B իՎՔԻ ej v n q|

cĪZv b msev`cĪ L t j Avgiv նեմբաճ ԻՎՔԻ i Pbv g t L v g v n B| thgb- msev`, cĪZte`b, մասնակցությամբ, Dcmասնակցությամբ, K j v g, ԻՄՒՒԻՒԻ, K v U Թ, tkŠZK GgbvK PUK`vi նեմբաճ| Gi tkvbuU Avgt`i m t_ L v i v c e`envi K t i tkvbuU f i j | thgb , i a m s e v ` , t j v R i v b t j v m o K ` ԻԹԵՎԻԿ 5 R b ն b n Z, M p e a y a m l Z, t c Թ c Ī v L u b K i v q Z i a x G i m W ` », ԻK s e v t k q v i e v R v t i t k t j s K v i x i L e i | c i k v c v n k m s e v ` c Ī i G K B c Բ v i e v t K v _ v q i t q t Q G K U v g R v i K v U Թ, n q Z Թ t F P Թ b v g K t M v L v ` Ի t q M i a t ` i g t a ` i m i j v c ԻՄՒՒԻՒԻ | A _ Թ m s e v ` c Ī u u n t Z Ի b t q B A v c b Գ l z, D t Ī v R Z, ` Ե L Z, D r K u U Z G e s G K B m t _ n i m i m l A b f e K i t j b | G K a i t b i Գ K A A b f v Z A v c b v i g t a ` K v R K i j | Ի K G K B g y t Z Գ k l c Բ v q g y Z G K u U e - A v B t U g A v c b v t K A v K l Գ K i t j v | t m L v t b G K u U g v b n E K m s M v t b i D t ` v t M t ` u b t _ t k c u v K m v R Թ x K t i A v m v e v s j v t ` t k i K t q K u U G i m W ` » t g t q i A b f v Z i K _ v t j L v A v t Q | Z v i v Z v t ` i G i m W ` » n l q v i նեմբաճ K i a x N U b v, Z v i c i նեմբաճ K v g q R x e b - h v c b g v b n E K m s M v t b i m v n v h ` j v f - նեմբաճ k - h v l v ԻՄՒՒԻՒԻ K r m v, f v t j v n t q ԻՎՔԻ A v m v G e s f i e l ` r ` c a K i b v i K _ v e ` 3 K t i t Q | i P b v u c v t v A v c b v i g t a ` m s e v ` c v V A v Z v i 3 G K a i t b i A b f v Z n t j v h v g v b n E K, A š l i ` u k Թ | A _ Թ G i P b v u Z ` K Ī v K v X Y Գ b q, N U b v i i M e t M e Y Թ v b q, G u U m y c v W ` ԻՄՒՒԻՒԻ v b K v i x G K u U i P b v |

ԳՂՔԻ ԻՄՒՒԻՒԻ P r b Թ x I t e p v i P r j Թ x 'Reporting' M Թ Š m s e v ` c Ī i Z ` c Թ v b K v i x m s e v ` (Hard News) Q v o v e v K x m e a i t b i i P b v t K B ԻՎՔԻ e v S t q t Q b | A e k ` m s e v ` c Ī i ԻՎՔԻ kãU c Թ j t b i i i a i Ի K ԻՎՔԻ e j t Z Z ` c Թ v b K v i x m s e v ` Q v o v e v K x m e Ի K Q t K B e S v t b v n t Z v | մասնակցությամբ, Dcmասնակցությամբ, K v U Թ G g b v K A v t j v K ԻՄՒՒԻՒԻ d t U ԻՎՔԻ e j v n t Z v | Ի K Š e Z Թ v t b ԻՎՔԻ e j t Z նեմբաճ Avte`b մասնակցությամբ իՎՔԻ i Pbv n q|

ԻՎՔԻ միջնակարգի ԻՎՔԻ i Pbv K v i A v j x A v k i v d Z v i u ԻՎՔԻ g v b g v j Թ M Թ Š ԻՎՔԻ i Ի Z b u m s A v Z t j a t i t Q b |

K. wdPvi nř"Q bxi m e`řK mi m Kři tZvj v| (Turning Lemon into Lomonade)

L. bMi t`vj vq Pto th Avb` jvf Kiv hivq wdPvi cori Avb` AřbKuv Zvi gřZvB|
(Akin to Surviving around a Maypole)

M. wdPvi nř"Q Ggb GK aiřbi weeiYř hvřZ AZ`ř ZřQ GKwU NUbřK GKwU cřg
tkřYi mřcvV` i Pbvq cwi YZ Kiv nq|

G msAv, řjv Aj skwi K nřj I G t`řK wdPřii `řc AřbKuvB Abřweb Kiv hivq|

wdPřii wclq

wepř wclq wbtq wdPvi i wPZ nřZ cři | Gi tKvb aiv evav mřgvbv tbB| wclqu wbfř
KiřQ wdPvi řj LřKi AvMř, `wřKvY, chřeřřřYi Dci | mseř`i wclq ZvrřřwYK NUbv|
wKř wdPřii wclq AZřZ, eZřvb, řiel`Z Křři th tKvb wKQynřZ cři | wdPvi thgb
nřZ cři řnM knři křgK Avř`vj b wbtq, řnřj b tKřři msMřgř Rřeb wbtq, řZgwb
nřZ cři KřwřDUřři řiel`Z tKvb mřřebv wbtq| Pjgvb tKvb wPř cř křř, řmřgvbri,
gř břUK, řjv wbtqř nřZ cři | nřZ cři tKvb HřZnřwřK w`kř cwi`kř, GgbKř
ebřřvRb wbtqř gřbvř wdPvi | A_ř wdPřii wclqi tKvb mřgv tbB| th tKvb wclq
wbtqB `Zix nřZ cři wdPvi |

wdPřii cřviřř

wclq e`i wřwřřřZ wdPvi wřwřwřcřvi nřZ cři | thgb:

1. gubřeK Avř`b mřwřwřwdPvi (Human interest Sketches)

wdPřii GKwU eo `eikř" Gi gubřeK Avř`b | G tkřYi wdPři gvbřři gubřeK msKU,
Avřv, AvřvLv, mř-`řřLi eYřv `řřK | G wdPři Awř mřvriY gvbřři Ggb tKvb wclq
w K Zřř aiv nřZ cři hv ZřřK řMři eřřřZ Kři | thřřřKři `řřG KRB gřřřvi `cř
řřři Křwřb thgb nřZ cři G tkřYi wdPřii wclq řZgwb nřZ cři GKRb řUvKvBřři
dřř wclq Křwřb|

2. e`wřZř;wPřYgř-K wdPvi (Personality Sketches)

mřvR ivřřq ev `eikřK řřř cřřwřZ Avřř wPZ e`wřZř`i wbtq G tkřYi wdPvi řj Lv nq|
Zřři mřřřř Mřwř, Rřeb hvcb, e`wřZř;G tkřYi wdPři Zřř aiv nq| G tkřYi wdPřii
wclq nřZ cři b mřwřwř`K, wřřř, Křř. řLřřvřvi, A_řwřwř` cřřř|

3. `řKřřwřřgř-K wdPvi (Confession Story)

tKvb wdPvi řj LK Zřř GKřřř AvřřK_v, řMřcb wclq wbtq wř Lřř cři b `řKřřwřřgř-K
wdPvi | G aiřbi wdPři thřřZze`wřři GKřřř Abřřřř řMřcb wclq `řb cřq ZřB G
wdPvi řjv mřřRB gubřeK Avř`b mřwř Kři | G wdPvi řjvi řřřv nq cřg cřřřř |
cřřřř G aiřbi wdPvi wbtq Confession Magazine I cřřřřř nřř `řřK|

4. *BwZnmwfiEK wdPvi* (Historical Feature)

HwZnmwK tKvb NUBv ev wefqe`' wbtq G tkwiYi wdPvi iWPZ nq| AZxšZi NUBvK mgťqvcřhvMx Kti Dc`vcb Kti G aiłbi wdPvi `Zix nq| thgbt BDřbř`v KZR.21 tk tdeaqviřK AvšR@ZK gvZfılv w em wntmte tNıYv Kiv Dcj řŋ iWPZ nřZ cvři 1952 mřj i exi Z;Mıv|

5. *weřkřYgj-K wdPvi* (Interpretative Feature)

mgKvjxb ivR%buZK, mgvıRK weřfbwełq wbtq weřkřYgj-K wdPvi `Zix nřZ cvři | thgb: Cř` XıKv t_řK MggřLv gvbtı i hvıv wbtq `Zix wdPvi |

6. *Dbqb wdPvi* (Development Feature)

mgřři weřfbwe`ři cšZıbqZ weřfbweDbqb KgřvŰ miKvix, temiKvix fıte mslMWZ nř`Q| G Dbqbři weřfbwe`K wbtq `Zix nřZ cvři wdPvi | thgb: e%eŰztmZwıbgřY cıkřZřRbRıeřb mslMWZ cwi eZř wbtq `Zix wdPvi |

7. *BDıwıj w wdPvi* (Utility Feature)

gvbtı i cřqıMK Rıeřb, cš`wnK Rıeřb KvřR jřM Ggb wełq wbtq wdPvi `Zix nřZ cvři | thgb: e`vsK FY wbtq KıřúDUvi tKbri Dcvq, wKsev evořZ eřm UıKv tivRMřı i Dcvq wbtq `Zix wdPvi |

8. *msev` wdPvi* (News Feature)

msevř` mřaviYZ gj- NUBvıW AZ`šKvřLıEvřıte Zřj aiv nq| wKš`msev` wdPři Zřj aiv nq Zıv gvıek w KıU| thgb Ljvřq Gıkv` wk`vi tMšZıv GKıU msev` | wKš` Gıkv` wk`ři i nřZ wbnZ Rbř` i AvZřřř` i AvııRııi wbtq `Zix nřZ cvři msev` wdPvi |

G Qıov Avřıv Avřıv weřPı aiłbi wełq wbtq wdPvi nřZ cvři | GLřb Ggıb GKıU wdPvi D`ıııY wntmte Zřj aiv nřjv:

gb fıřjv řZv me fıřjv

gb fıřjv řZv me fıřjv| gb fıřjv tbB řZv wKQB fıřjv tbB| GB gřbi AřbK wKQB nřZ cvři | gb Lvıvc nřZ cvři, DřšM Avi DrKÉvq řři DVřZ cvři, `řšMš` nřZ cvři | gb Lvıvc nřřřQ wKřřte eřřeb? hıw` wKQB Avcbıı fıřjv bv jřřM, wPw UKřıv UKřıv Kti wQto tdřj b, Rıvıjıı wK aři Avbğřb `wđq_vřKb Ges Gřřte Přj w řbi ci w b Zv nřj eřřřZ nte Avcbıı gb Lvıvc nřřřQ| G Rb` tLřZ nte weAvcbı fıřıv ōj wı wıj eıwKv/ř wıř weAvřřb wKQıv b cřeGgııı c_ evřřj wQj GKıU eıRıwZK tKvııııı| Avi hıw` Avřııb e`emıvqx nb Zvntj nqZ řŰŰıı tđřřřQb GKıU ,ıæřçř`

cĀZōv̄t̄bi ev̄t. A_ev Rv̄n̄v̄t̄R Av̄m̄t̄Q Av̄cb̄vi gv̄j | tUŪv̄iū c̄v̄teb w̄k bv, Rv̄n̄v̄Riū
w̄b̄iv̄c̄t` Ḡtm w̄fōte w̄k bv G w̄bt̄q n̄v̄R̄īv̄i w̄P̄š̄t- w̄ōš̄iM̄ō̄īn̄t̄j̄v gb| Av̄c̄iūb h̄w̄ teK̄vi
Ziāx̄ t̄n̄vb, Z̄v̄n̄t̄j Gev̄i P̄v̄K̄v̄iUv̄ n̄te w̄K̄bv, c̄v̄t̄ki d̄v̄t̄Ui D̄w̄k t`q̄v t̄ḡt̄q̄iUi m̄v̄t_ t̄c̄ō
n̄te w̄K̄bv G w̄bt̄q Av̄kv̄-w̄b̄iv̄k̄vi t`v̄j v̄P̄t̄j Av̄cb̄vi gb| ḡt̄bi Gme mḡm̄v̄ mḡv̄v̄t̄bi R̄t̄b̄
b̄M̄ix̄Z Av̄cb̄vi R̄t̄b̄ Av̄t̄Q n̄v̄R̄vi c_ | t`š̄ov̄b t̄R̄w̄Z̄Īx Av̄cb̄vi n̄v̄t̄Z̄i t̄iLv̄ t`t̄L
ej̄t̄eb Av̄cb̄vi ḡj̄j īw̄ki c̄v̄t̄k k̄v̄bi fi GK̄UzAv̄t̄Q! Z̄te c̄v̄b̄e c̄v̄_i w̄bt̄j t̄K̄t̄U h̄r̄te
m̄K̄j ḡȳōeZ | t`b n̄v̄R̄vi Uv̄K̄v | c̄xi m̄v̄t̄ne P̄q̄z̄ēt̄R ej̄t̄j b, ūdz̄hv̄ tel̄v̄ me f̄v̄t̄j v̄ō- e`m
Ḡḡiūb P̄z̄K t̄M̄j m̄K̄j S̄v̄t̄ḡj v | Av̄cb̄vi gb GL̄b d̄K̄b̄iK̄v |

GB gb w̄bt̄q ūgb f̄v̄t̄j v̄ t̄Z̄v me f̄v̄t̄j v̄ w̄k̄t̄iv̄v̄t̄ḡō G m̄B̄v̄t̄n b̄M̄ix̄Z Ab̄ȳōZ n̄t̄j v̄ GK
e`w̄Z̄μ̄ḡx Dr̄me- ōt̄K̄v̄q̄v̄Uv̄g Dr̄meō | th̄v̄M̄ t̄ḡw̄t̄Uk̄b P̄P̄q̄ 13 eQ̄i Ges t̄K̄v̄q̄v̄Uv̄g t̄g_w
t̄ḡw̄t̄Uk̄b t̄K̄v̄t̄m̄P̄ 2q eI c̄w̄Z̄D̄c̄j t̄q̄ G Ab̄ōv̄t̄bi Av̄t̄q̄v̄R̄b K̄t̄i th̄v̄M̄ d̄v̄D̄t̄Ūk̄b | M̄Z
īμ̄ev̄i B̄v̄w̄b̄q̄v̄i s B̄ȲiūŪDU ūḡj b̄v̄q̄Z̄t̄b m̄K̄v̄j 10Uv̄q Ab̄ōv̄t̄bi D̄t̄ōv̄ab K̄t̄i b R̄v̄Z̄x̄q
Aa`v̄c̄K W̄t b̄j̄aj B̄m̄j v̄g |

m̄K̄v̄j m̄v̄t̄o 10Uv̄q m̄v̄t̄eK̄ miK̄v̄t̄i i m̄iPe Ges īv̄ōc̄w̄Z̄i D̄c̄t`ōv̄ K̄v̄R̄x̄ d̄R̄j̄j̄ īnḡv̄t̄bi
m̄f̄v̄ic̄w̄Z̄t̄j̄ Ab̄ȳōZ n̄q `š̄Z̄P̄v̄iȲ I Av̄t̄j v̄P̄b̄v̄ Ab̄ōv̄b | `š̄Z̄P̄v̄iȲ w̄ek̄ō e`īv̄eM̄`th̄v̄M̄
m̄v̄ab̄vi d̄t̄j Z̄v̄t̄`i ḡt̄bi D̄ci w̄b̄q̄š̄ȳ cĀZōv̄ K̄t̄i th̄me Aw̄ek̄l̄m̄` m̄v̄d̄j̄` j̄v̄f K̄t̄i t̄Q̄b
Z̄vi eȲōv̄ t`b | X̄v̄K̄v̄ w̄ek̄t̄e`ij̄ t̄q̄i w̄k̄q̄t̄K̄ W̄t ḡv̄nḡȳ Dj Av̄iūgb ej̄t̄j b, w̄Z̄iūb `x̄N̄e18 eQ̄i
āt̄i D`P̄ īv̄P̄v̄t̄c̄ f̄t̄h̄iQ̄t̄j b | t̄K̄v̄b w̄P̄v̄K̄r̄m̄v̄q̄B K̄v̄R̄ n̄q̄iūb- giȲv̄cb̄e Ae`v̄ n̄t̄q̄iQ̄j |
Aēt̄k̄t̄l̄ th̄v̄M̄ m̄v̄ab̄vi ḡv̄a`t̄ḡ w̄Z̄iūb G t̄iūM̄ t`t̄K̄ c̄j̄iv̄c̄ȳj̄ ḡw̄p̄ j̄v̄f K̄t̄i t̄Q̄b | GK̄B
w̄ek̄t̄e`ij̄ t̄q̄i d̄iūj Z̄ c`v̄`e`vi c̄f̄v̄iūl K̄v̄ m̄j̄v̄B̄q̄v̄ K̄ix̄g R̄v̄b̄iūb, w̄Z̄iūb Q̄v̄T̄x̄ R̄x̄ēt̄b f̄ij
t̄iR̄v̄ē K̄i t̄eb Ḡḡb̄iūB Av̄kv̄ K̄t̄i b̄iūb | w̄K̄š` th̄v̄M̄ m̄v̄ab̄vi ci w̄Z̄iūb ḠZ̄Uv̄ Av̄Z̄w̄ek̄l̄m̄x̄ n̄t̄q̄
D̄t̄V̄b th̄ w̄Z̄iūb w̄ek̄t̄e`ij̄ t̄q̄i w̄k̄w̄q̄K̄v̄ n̄l̄q̄vi kc_ t̄bb | cieZ̄ēZ̄ w̄Z̄iūb ĪB f̄v̄t̄j v̄
t̄iR̄v̄ēB K̄t̄i b̄iūb- w̄ek̄t̄e`ij̄ t̄q̄i w̄k̄w̄q̄K̄v̄l n̄b | `š̄Z̄P̄v̄iȲ m̄K̄j w̄k̄īc̄w̄Z̄, e`em̄v̄q̄x,
w̄P̄v̄K̄r̄m̄K̄ th̄v̄M̄m̄v̄ab̄vi ḡv̄a`t̄ḡ Z̄v̄t̄`i R̄x̄ēt̄bi Af̄w̄eZ̄ m̄v̄d̄t̄j̄`i eȲōv̄ t`b |

R̄v̄Z̄x̄q Aa`v̄c̄K W̄t b̄j̄aj B̄m̄j v̄g ej̄t̄j b, A`v̄t̄j v̄c`v_x̄ w̄P̄v̄K̄r̄m̄v̄ c̄x̄w̄Z̄i Āt̄b̄K̄ m̄x̄ḡv̄ēx̄Z̄v̄
Av̄t̄Q | Āt̄b̄K̄ w̄K̄Q̄B̄ ḡt̄bi D̄ci w̄b̄f̄P̄ K̄t̄i | w̄Z̄iūb Z̄vi `xi D`v̄n̄iȲ w̄t̄q̄ ej̄t̄j b, Av̄ḡvi `x̄
Ḡḡiūb̄t̄Z̄ n̄t̄P̄b̄ b̄v | w̄K̄š` h̄L̄b īv̄t̄Z̄ Av̄ḡvi m̄v̄t̄_ īt̄Z̄ h̄iūb Z̄L̄b f̄v̄t̄eb Z̄iū n̄v̄v̄ D̄iPr̄ b̄q-
w̄K̄š` Z̄L̄b̄B n̄w̄P̄ īīǣn̄q | W̄t b̄j̄aj B̄m̄j v̄t̄gi t̄K̄š̄Z̄K̄c̄Ȳe`e`3̄te` m̄v̄iū ūḡj b̄v̄q̄Z̄t̄b n̄v̄m̄i
eb̄v̄ ēt̄q̄ h̄v̄q | R̄b̄ve B̄m̄j v̄g ej̄t̄j b, n̄v̄m̄c̄v̄Z̄v̄t̄j̄ k̄Z̄K̄iv̄ 40 f̄iūM̄ t̄iūM̄xi ĪĪj̄aīB̄ c̄ōq̄v̄R̄b
n̄q̄ b̄v | Z̄v̄t̄`i īaḡv̄l̄ ḡiūb̄m̄K̄f̄v̄t̄e m̄v̄n̄m̄ w̄t̄j̄B̄ n̄q | b̄j̄aj B̄m̄j v̄g K̄w̄eZ̄vi X̄st̄q̄ ej̄t̄j b-
gb th̄L̄v̄t̄b c̄k`V̄k̄ix̄i t̄m̄L̄v̄t̄b k̄v̄š̄ | h̄vi Av̄Z̄w̄ek̄l̄m̄ m̄v̄ōīB̄ GK̄iū c̄x̄w̄Z̄ n̄t`Q̄ t̄K̄v̄q̄Uv̄g
c̄x̄w̄Z̄ | w̄Z̄iūb Aēk` Gi c̄Z̄v̄iȲvi w̄el̄t̄q̄l̄ m̄Z̄K̄K̄t̄i t`b | mēt̄k̄t̄l̄ Ab̄ōv̄t̄bi D̄t`v̄v̄v̄
ḡn̄v̄R̄v̄Z̄K̄ kn̄x` Av̄j̄ t̄ev̄L̄v̄ix̄ ej̄t̄j b- ūc̄v̄i t̄ev̄ō h̄L̄b ej̄t̄eb Z̄L̄b̄B c̄w̄i t̄ek̄ c̄w̄i w̄w̄Z̄ e`t̄j
h̄v̄t̄e | Av̄c̄iūb m̄w̄Z̄B̄ c̄v̄i t̄eb | gb̄B n̄t`Q̄ Av̄m̄j K_v | me K_v̄i t̄kl̄ K_v̄ gb f̄v̄t̄j v̄ t̄Z̄v
me f̄v̄t̄j v̄ |

t̄m̄ w̄b̄ ḡn̄v̄b̄M̄ix̄i GB e`w̄Z̄μ̄ḡaḡP̄ Ab̄ōv̄b̄iū t̄kl̄ n̄l̄q̄vi ci t`L̄j̄v̄g me Av̄ḡiūš̄Z̄ Av̄w̄Z̄
n̄v̄m̄L̄ȳk̄ f̄v̄t̄e P̄t̄j h̄v̄t`Q̄b | w̄K̄š` h̄L̄b̄B Av̄ḡvi ḡv_v̄q̄ Ḡt̄j v̄ GB Ab̄ōv̄b̄iū w̄bt̄q̄ Av̄ḡv̄t̄K̄

~ž Ae GWžKkb

wdPvi ij LtZ nte WK ZLbB gb Lvivc ntq tMj | Zey fimv ōgb fvtjv tZv me fvtj v!Ō
Avcbviv WK etj b?

– tkvqvBe wReivb, ~wbK RbZv, 09/01/1995Bs

wdPvi iPbv tKškj

tQvU Mī ev ūbežŪi gtZv wdPvti i l _vtK wZbŪw fŪM| h_v mPbv, we ~li l Dcmsnvi |

mPbv (Intro/Lead)

wdPvi iPbvi tŋtŪ mPbv GKŪW AZ“šl , iazcYelq| KviY, mPbv ctoB GKRB cvVK
wdPviŪi cŪZ AvKó.nŧeb| GRb“ mPbv nI qv DŪPZ AvKIŋxq, Avte`b mŪKvix| G Rb“
mPbvq e`envi Kiv nq weŪPŪ c×wZ| thgb–

buUKxq mPbv (Distinctive Incident Lead): G aižbi mPbvq buUKxq gŪtZP Qwe Zžj
aiv nq| GžZ cvVK wdPviŪi cŪZ mnžRB AvKó.nb| thgb: Mij wŪtZ Aaxi AvMŋn eŧm
AvŧQb`kRiv| GLbB iiaente dŪej gŪPŪ| nVir Pvi w žK tmvi tMj iiaenj
.|

D×wZ. mPbv (Question Lead): wdPvti i mPbvq D×wZi e`envi Kiv thžZ cvti | thgb,
GKŪW tŋtŋi AvZŋZv ūbtŋ iŪPZ wdPvti e`eüZ nžZ cvti Rxebvbt`i ŪAvU eQi AvŧMŌ
KweZŪi cŪw³ |

÷`vKŪUv mPbv (Staceato Lead): tQvU tQvU evK“ w žq G tkŪYi wdPvti i mPbv nq| GžZ
`Zix nq tŪbkb| thgb- nVir , wj , AvZŋPrKvi | Zvici ūbieZv| nVir |

ūcKŪUwŪi qvb mPbv (Picture Lead): G tkŪYi mPbvq ktāi mŪvŧh“ thb Qwe Zžj aiv
nq| thgb: ūcbcZb ūbieZvi wŪZi gŧĀ axti axti Ržj DVtjv Avtjv| wZŪb axti axti
exYv tKvŧj Zžj ūbtj b|

cŪkæmPbv (Question Lead): cŪkæw žq G tkŪYi wdPvti i mPbv nq| thgb- evm`ŪUŪvi
ūbnZ GKRB ūcZvtK ūbtŋ iŪPZ wdPvti i mPbv- evmv t_žK teižbvi mgq wZŪb Zvi ūcŪ
Kb`vtK PŋyLŧq etj ūtj b- AvŪm gv; GŪŪB ūQj Zvi tkl Pŋy, wZŪb WK RibžZb?

thfŪteB mPbv tŪvK bv tKb wdPvti i ga`fvŧM _vtK Zvi we`li | wŪwĒ`vctbi ci BŧŪi
ci BU mŪwRžq thgb`Zix nq`vj vb, žZgŪb we`li Astk gj- ūelqŪi eqb Mto DŧV| G
eqtb e`eüZ nžZ cvti Dcgv, D`vniY, D×wZ, cŪmŪžK ūelŧŋi AeZviYv| Zte gŧb
ivLžZ nte gj- ūelq t_žK`fi hvl qv WK nte bv| ZvtZ cvVK AvMŋn nŪvŧžq tŧj žZ
cvtib, ūei³ nžZ cvtib| we`li AstkB gj- ūelqŪi , ūQžq etj tŧj žZ nte| Zvici
Dcmsnvi | Dcmsnvi GKŪW wdPvti i Rb“ LŋB , iazcYelqAsk| G AstkB wdPvti i mPbv
l we`li Astk cvŧKi gŧb th fŪtei mĀvi NŧŪtQ Zv tgvŋg chŧŋq tŧŪQ w žZ nte|
GRb“ GŪŪ nI qv DŪPZ teMeib AvteMgq l gŧvŪi g| cvŧKi KŪtQ Poviš gŪbūeK teŪŪ

welqIU hvPvB Kivi ci wZwb GKIU Lmov cvUij mc cŔZ Ktib| Zivci hw` ubqg Kiv
_vtK, Zvntj tm tʻŋtĭ Lmov cvUij mcIU welq wekIA (Subject Specialist) ev tidvixi
KvtQ tcŦY Ktib| welq wekIA cvUij mcIU h_v_Œv wePvi Kti gZvgZ mn mʻuv` tKi
KvtQ tcŦY Ktib| mʻuv`K welq wekIAi cŦB gZvgZi wfiEtZ cŦqRbtefta msikŦ
tj LtiKti mnthvMzvq tj LvwLi cŦqRbxq mstkvab cvigvRŦ Kti GKIU Poviš cvUij mc
cŔZ Ktib| Gi ctib mʻubæng mʻuv`bvi cŦ_ugK chŦq|

g-Ÿ chŦq mʻuv`bv

Poviš cvUij mc cŔZ nlqvi ci Avtm g-ŸYi KvR| g-ŸYi cŦg chŦqB nt”Q KtʻuvR|
AvtMKvi w`tb GKvRwU Kiv ntZv n’vŦ KtʻuvRi gva’tg| eZŧvB KivDvvi Avmvg G
KvRwU ʻz I mvejxj fite mʻubæKiv hvq| mʻuv`bvi G chŦqi metPtq ʻiaZcYKvR
nt”Q cŦd mstkvab|

cŦd mstkvab

cŦd mstkvatbi gva’tgB gyZ melqi wbfʻZv I cvv”Obzv wvŦZ Kiv nq| mʻuv`bvi
tŧtĭ G KvRwU AZššweivKi I GKtNtq| Z_wc, %ahŦ tckv`vix gb wbtq wbtgæ³
KvŸY GKRb mʻuv`KtK G KvRwU mŧvifvte mʻubæKiv nq| h_v:

1. evbvb i × ivLv|
2. h_vh_ AvKvii (Face) UvBtci e`envi, cvbthvM’Zv I melqe`i aiY Abjvqx wewfbæ
AvKvii UvBc e`envi wvŦZ Kiv|
3. mWK Ae`vb wbfcb, kxlŦdckxlŦvcb, AbŸQ` wK ivLv|
4. mgZv weavb jvBb ci`ui`iZj I cŦšK`vb (Margin) wK ivLv|
5. mZ’Zv iŧv, cvUij mcZŸ wj wLZ melq g-ŸY cvv cYŧvte msiŧY Kiv|

cŦd mstkvatbi Rb” wKvŧv BDvbfwIU tcŦh KZŦ cŦvKvZ ŦG g’vbgvj Ae ÷vBj Ŧ
Ges Ŧ÷vBj g’vbgvj Ae w` BDvBtUW t÷Ŧm&MfYŧU wvŦUs AvcmŦ MŦš” wbt`ŦKZ bgyv
wewfbæ t`tki tcŦmgŧ AbŸvY Kti | GKRb mʻuv`KtK cŦd mstkvatbi Rb” tm imZ
cxwZ AvqZj Kiv nte|

cŦd mstkvatbi KvRwU cxwZMZ mʻubæKivi Rb” KZK ʻtjv mstKwZK wPtji D”teb
Kiv ntqtQ| evsjvvn cv`exi eũ fvlvq G mstKwZK wPymgŧ e`eũZ nq| G ʻtjvtK
cŦd mstkvatbi mstKwZK wPy (Proof Reade’s Hints) ejv nq| wbtgæG wPymgŧ Ges
G wPymgŧni e`envtii gva’tg cŦd mstkvatbi GKIU bgyv evDve cŦvKvZ W. G tK
Gbgj nK I mijgv Kvi g cŦyZ Ŧcvw’mvGMŦ cŦqb e`envvii KvŦ cv’Kv t`tk Ztj aiv
ntjv|

cd iil/s-Gi Rb" e"üZ ms#KZmgn-

	delete	bf or bold	boldface
stct	let original stand	Rom.	Roman type
/ ^	insert	ital	italics
	separate letter or words	l.c.	lower case (small letters)
	joining	u.c	upper case (capitals)
/	delete and join	u.c.l.c	print in lower case but capitalize
⊙	full stop (period)	(-)	hyphen
^ ,	comma	$\frac{1}{n}$	en dash (short)
/;	semi-colon	$\frac{1}{m}$	em dash (long)
⊙ :	colon	wf	wrong font
V . V	insert quotation marks	x	broken or wrong type
or NP	new para	sp out	spell out
#	insert space	press	instructions to press
line #	insert space between lines	word	correct spelling, form to be followed
run-on	run on	□	large editorial insertions
	drop text after this mark down to the next line	↑ ↓	provide line
tr or	transpose	?	query

ctt` Lvi bgly

“বাগদা চাষ না নীল চাষ” বন্ধ হয়ে কহিলেন যে সেদিন এক বন্ধু ১৫/১২/১৯
 তার মুখ দেখে মনে হল খুব গভীর থেকে যেন তার এ ধনিটা বের হয়েছে। ১৫/১২/১৯
 বললাম, “বল কি হে, বাগদা যাঁরা আর নীলচাষ তো আল্লাদা ব্যাপার। ১৫/১২/১৯
 চালা শাসকরা জোর জবরুস্তি করত তাদের স্বার্থে আর কিন্তু স্বাধীন হয়েছি, ১৫/১২/১৯
 টিশ মেছে সে কবে তার পর পাকিস্তান আমরা একটা স্বাধীন জাতি। বাগদা ১৫/১২/১৯
 # চাষ করে আমাদের দেশের অর্থনৈতিক বুনয়াদ দুট হছে প্রচুর বিদেশিক মুদ্রা ১৫/১২/১৯
 অর্জিত হছে এসব তো ফাঁদীর দেশের সাথে” বন্ধুটি এবার বললেন, ১৫/১২/১৯
 “দেশের স্বার্থ আর গরীবের স্বার্থ কি আজ এক? সেটা ভাবার প্রয়োজন ১৫/১২/১৯
 আমাদের এ শ্রেণী বিভক্ত সমাজে। ব্রিটিশ বাংলায় নীল চাষ করা হত ১৫/১২/১৯
 শাসকদের স্বার্থে (S;l-Shlcc) করে তার বেশী নির্যাতিত আর ক্ষতিগ্রস্ত ১৫/১২/১৯
 হতো গরিবরা। কিন্তু আজ কয়েক যুগ পরও দেশ যাচ্ছে স্বাধীন দেশের ১৫/১২/১৯
 অর্থনৈতিক দুট বুনয়াদ গড়ে তুলতে ইটালিয়ান মুদ্রা অর্জনের জন্য যে বাগদা ১৫/১২/১৯
 চিৎড়ি চাষ করা কছে তার ফলেও বেশী নির্যাতিত হছে গরিবরা আর ১৫/১২/১৯
 মানবাধিকার লংঘনের ঘটনাও ঘটছে বেশী। ভিন্ন হলে, শিক্ষাপত্র ওই একই ১৫/১২/১৯
 আগে নির্যাতিত করতো।”

mstkwaZ Kvc

MāK Lagos kā t_#K BstīRx Language ktāi DrcwĒ| Mātm Lagos Ōviv we`v kw³
 tevSv#bv n#Zv| ms`#Z K_v ejv A#_#fvl# avZzt_#K fvlv kāmU G#m#Q| m#ivs t`Lv
 hv#`Q, cĒ:ĀWī mvt_ #PŠl I cKv#ki Mfxi m#uK#itq#Q| fvlvi mrvv#h`B gvby Zvi
 #PŠl, a`vb aivYv, g#bi fve cKvk K#i| Pvj m#Gd, n#K#Ui g#Z, fvlv n#`Q gvby#i
 Ggb GK Abb`mjf `ewkó” (Differentia) hv Ab` cŌYx t_#K gvby#K `#ZŠj `vb
 K#i#Q| gvby Zvi G gnr %#kó`u nvrvi nvrvi eQ#i i μgweKv#ki aivvq AR# K#i#Q|
 Abgvb Kiv nq cŌq c#P j`# ermi Av#M t_#K gvby Zvi R#eb hvct#b cvi`ūwi K
 thvM#thv#Mi t`#t# m#Lj fvlv e`envi K#i Avm#Q|

ÁvbZvĒK `wóf#z t_#K fvlv#RÁvmvi m#f-cvZ Mātm| tntiv#WvUv#mi iPbvq Zvi cwiPq
 cvlqv hvq| c#Pxb fvi#Z cwiYvb, hv#e, cZÁvj fvlv #PŠli t`#t# D#j`#thvM` bvg| Zte,
 fvlv#K `eÁvbK `w#KvY I f#z t_#K we#k#t#Yi m#f-cvZ E#bk kZ#K| fvlv #RÁvmv
 Áv#bi GK#U we#k#l#vqZ kvLv hv#K ejv n#`Q fvlv#eÁvb (Linguistics)| G B#v#t#U fvlv
 weÁvb I fvlv#eÁv#bi Av#j vP` we#lq m#ú#K#we`hvi Z Av#j vPbv cv#eb| cvW, t#j#K
 #b#t#e³ f#te m#Rv#bv n#t#Q|

Āġ Ae GwġKkb

Aek" eZ@vġb cġd t`Lvi G weiw³i KivRiU mnt`R Kivi Rb" KivúDUvġiB t`új tPKvi msthvRb Kiv ntq _vġK|

MġdK wVRvBb wPĀ msthvRb

cġd t`Lvi ci eBiUi wewfbaeRvqMvq cġqvRbxq Qwe, wPĀ, Aj sKiY, Mġd, KvUġ BZ`w` h_vh_fvġe msthvRb Kiv ntq _vġK| G KvRiU KivúDUvġii gva`ġgB m`úbæKiv thġZ cvġi, A_ev cġqvRbxq `vb dġKv tiġL H `vġb cġi Qwe msthvRb Kiv thġZ cvġi| KvRiU m`úbæKivi Rb" m`úv` Kiv mrvaiibZ MġdK wVRvBbvġii mrvh" I civgk`ġbġq _vġKb|

tUm Kiv

G KvR,tjv m`úbænl qvi ci eBiUi ev cvMvgMġi cġwfvġĒK Ppvśl bKkv Kiv teivġq Avġm hvġK ejv nq tUġms| G tUġms Kiv,tj vġK cieZġmgġq tcóvi iv wbt`R Abġvqġ tRvov jwġġq cġZ Kġib cvMvgMġ g`ġYi gj- bxj b- v| m`úv`K G gj- bxj b- wġ cixġv Kġi t`ġLb| Gwġ mwK ntj Zv g`ġYi e`e`v tbqv nq| wbtP GKwġ wPġĀi mrvvġh" cġiv cġġqvġU t`Lvġbv thġZ cvġi:

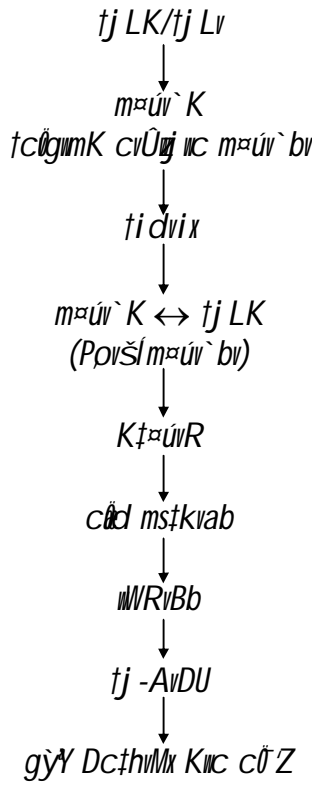



cvʹVĖi gj-ʹiqb: 5.4

A) msʹŋB DĖi cĕæ

1. mʹúv ʹKi cĕvb ʹvqZ; mʹŋc eYĖn Kiab|
2. mʹúv ʹbri cĕvb ʹŋ chĕq Kx, eŋstq ej ʹ|
3. cĕd mʹkvab ʹKb ʹiæZcY?
4. cĕdi cĕvb Dʹi k ʹ Kx?
5. cĕd mʹkvab Kiab:

gj- cvʹ eB ʹij L Drcv ʹtb chĕq telq mʹúv ʹbv| ÷vBj mʹúv ʹbv; Kŋci vBU
AbŋvZ MĕY chĕqμtg cvŪij ʹc Mĕb G me KŋR Ki nI |

i x iĕ

gj- cvʹ eB ʹij Lv I Drcv ʹtbi chĕq ŋelq mʹúv ʹbv, ÷vBj mʹúv ʹbv, Kŋc i vBU
AbŋvZ MĕY chĕqμtg cvŪij ʹc MĕY G me KŋR Kiv nq|



Povšĭ gj-ʹiqb

A) i Pbvġj-K cĕæ

1. cvʹcŷK cĕqʹbi ʹKškj eYĖn Kiab| G cĕt½ Ab ʹ th ʹKvb ʹʹki D ʹvniY
ʹ b|
2. cvʹcŷK gj-ʹiqʹbi cĕμqv eYĖn Kiab|
3. cĕÜ i Pbv c x ŋZ eYĖn Kiab|
4. ŋdPvi ŋK? ŋdPvi i cĕvi ʹf ʹ eYĖn Kiab|
5. ŌŋdPvi i Pbv i Rb ʹ Pvb GKŋŋ gvbŋeK gbŌ Dŋvŋŋi ʹcĕŋŋ GKŋŋ cĕÜ i Pbv
Kiab|
6. mʹúv ʹbri cvŪij ʹc I gŷY avcmgŋ eYĖn Kiab|

ᄡ Ae GWKkb

mgyarb Kwi | Avgvᄡi ᄡZᄡZ msiwᄡZ AvᄡQ Avgvᄡi Ávb I AwfÁZv tᄡK cvlqv
wevfbaez_| Gme Z_ Avgiv mslMh KᄡiᄡQ Avgvᄡi Bw`ᄡqi gvaᄡg| KwúDUvi I Zvi
ᄡZᄡZ Z_ aᄡi ivLᄡQ Ges ᄡbqšᄡKi mnvᄡᄡ cᄡqvRbxq weᄡkᄡYgj-K KvhKgᄡKiᄡQ/
KwúDUvi Zvi Bbcᄡ ᄡWfvBᄡRi gvaᄡg Gme Z_ MhY KiᄡQ| Avgiv thgb Avgvᄡi
ᄡZᄡZ msiwᄡZ Z_ e`envi Kᄡi Avgvᄡi gw`ᄡi mnvᄡᄡ Z_v wevfbaegvsmᄡckx Pvj bvi
gvaᄡg mgm`vi mgyarb Kwi, KwúDUvi I tZgᄡb Zvi ᄡZᄡZ msiwᄡZ Z_ tK`ᄡq cᄡqv
wefvᄡMi (CPU) mnvᄡᄡ mgm`vi mgyarb Kᄡi Ges Zv wfiᄡBD, ᄡcᄡvi BZ`w`i gvaᄡg
cᄡkv Kᄡi |

AvanbK KwúDUvᄡi i cᄡvb Ask cᄡvᄡU:

- tK`ᄡq cᄡqv wefvᄡ (CPU)
- tgBb tggix ev gj- ᄡZ fivᄡi (Primary storage)
- e`ᄡKs t`vi (Auxiliary store)
- Bbcᄡ BDᄡbU
- AvDUcᄡ BDᄡbU |

KwúDUvᄡi i G Ask, ᄡj vᄡK nvᄡPqvi etj | ᄡᄡPi ᄡPᄡ KwúDUvᄡi i MVbZšᄡt`Lvᄡ nj |

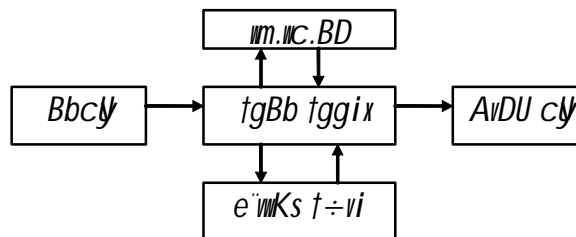

ᄡPᄡ 6-1.1: ᄡPᄡ Zxi ᄡPvᄡZ cᄡvb Ask, ᄡj vi gᄡa` mshvᄡKvix ti Lv, ᄡj v e`ᄡZK Zvᄡi i
cᄡxKiᄡc cᄡᄡZ nᄡqᄡQ|

mshvᄡKvix Zvi, ᄡj vᄡK evᄡmm (Busses) etj | GB mshvᄡKvix Zvᄡi i ga` ᄡᄡq e`ᄡZK
mᄡKZ Pj vPj Kᄡi | DcvĚ Mgb I ᄡbMᄡb cᄡtK evm (Bus) etj | evm e`ᄡZK
mᄡKᄡZi gvaᄡg DcvĚ cᄡienY Kᄡi vᄡK| th me tWUv weᄡkᄡY KiᄡZ nᄡe, Bbcᄡ
BDᄡbU tm me tWUv cᄡᄡg tgBb tggixᄡZ `vcb Kᄡi ev ᄡᄡq hvq|

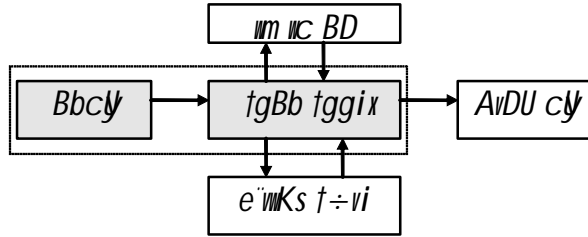

ıPĤ 6-1.2: nekřiřYi Rb` tWUv cĬtg Bbcly ıWfıBřRi gvařtg tgBb tggixřZ `ıvıřlı Z nq|

tgBb tggixřZ tWUv GKevi `micZ nřj, ımicBD tgBb tggix t_řK tmB tWUv tei Kři Avřb Ges ZřřK ıeb`řKři |

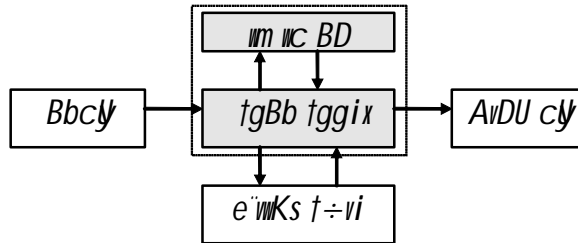

ıPĤ 6-1.3: ımicBD tgBb tggix t_řK tWUv tei Kři Avřb Ges ıeb`řKři |

KıřıDUvi ıeb`ımkZ. tWUv mřariYZ tgBb tggixřZ ıclııřq ř`q Ges AvDUcly BDıbu e`enrı Křixi ıbKU dj cĬvb Kři (e`vıřKs t÷vi KLřbv KLřbv AvDUclyřıi KřıRI Kři)|

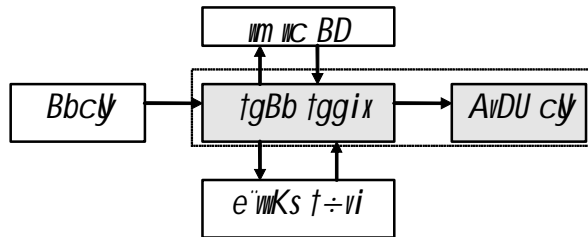

ıPĤ 6-1.4: tWUv GKevi ıeb`řnřj, Zř tgBb tggixřZ ıclıı hřq| tgBb tggix t_řK AvDUcly ıWfıBřRi gvařtg KıřıDUvi e`enrı Křixř`i ıbKU dj Dc`ıcb Kři |

1. řK`řq cĬıqıv ıefıM (CPU)

Askıgřni eYřv

GıU KıřıDUřıi cĀvb Ask| GřZ GKıU mımkř teW`řK hřřZ cĀvb gıBřıv-cĬmmi, AvZııı³ gıBřıv-cĬmmi thgb Bbcly ev AvDUcly ıWfıBřRi Kıřıřjx ıbqřYKřix gıBřıv-cĬmmi, Ab`ıv` mıııq Dcı`ıv I ıPcmgř, eıv ev nıBI řq bıgK mřřıv gvařgi mıvıřř` cı`ıı mřřY `řK| KıřıDUřıi tKıv hřřsk t_řK Ab` hřřřřk cı`ııı gřa`

~q Ae GW#Kkb

we`y mstKZ Av`vb c^ v#bi gva`gtK evm ev n#Bl tq etj | GiU GK „Q Zv#i mgw# ev K#uDUv#i i p#c AvZ m# m#wi evn# ti Lvmgr#i n#Z cv#i | K#uDUv#i tWUv c#uq#KiY, #b#`R cij b Ges Ab`vb` me Ast#ki K#h#ej#x #bq#s#Z nq GB #m#BD Gi gva`tg | #m#BD-tZ #Z#uU c#vb Ask Av#Q:

- K#U#j BD#uU ev #bq#s#Y GKK |
- A`wi`_#guUK/j #RK BD#uU(MYbv/h#y# GKK)/GGj BD (ALU) |
- #ggix |

c#Z#uU BD#uU#i i #q#Q #b#`# K#h#ej# ev #uq#Kjvc |

- **K#U#j BD#uU ev #bq#s#Y GKK**– GiU K#uDUv#i i hveZiq K#RKg#K #bq#s#Y K#i | K#uDUv#i K#R Kivi Rb` th #b#`R ev tc#M#g t`Iqv nq, K#U#j BD#uU #m Ab#v#iB me #bq#s#Y K#i _v#K | K#U#j BD#uU MYbv #efv#Mi hveZiq #bq#s#Ygj-K K#R m#u#`b K#i | K#uDUv#i GB m#p#s #mKkb #efb#em#p#i gva`tg #m#v#MZ Z` M#Y K#i Ges #m#v#s#l #bq | K#U#j BD#uU Ab`vb` c#s#q ev tc#v#t#di#v (Peripheral) BD#uU #hgb- K#te#W#©,gvDm, gv#u#i BZ`#i K#RKg#© #bq#s#Y K#i | H Z#_`i #f#E#Z #K K#R Ki#Z n#e Ges KLb Ki#Z n#e GB Z`vi#K #bq#s#Y K#i |

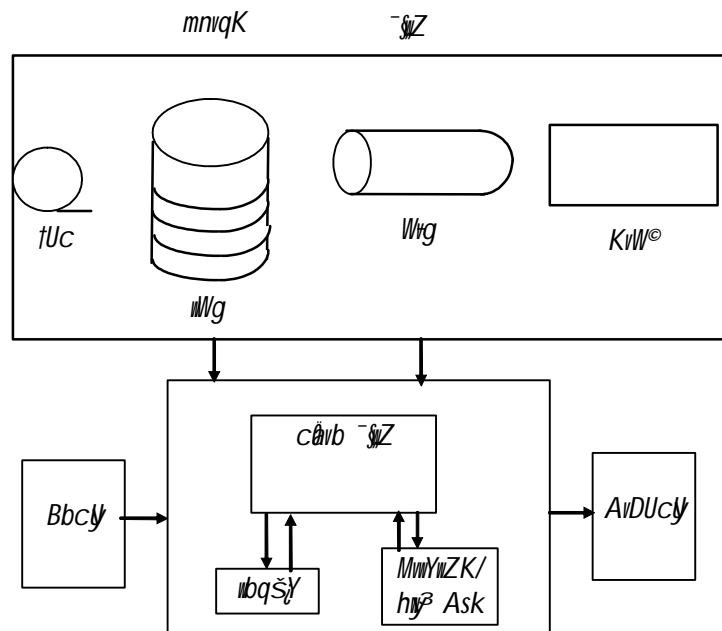

#P# 6-1.5: #m#BD |

- **A`wi`_#guUK j#RK BD#uU/M#v#v#ZK h#y# GKK**– K#uDUv#i i #m#BD ev gv#t#v#c#m#m#i GB Ask M#v#v#ZK Ges th#s#K K#R, #j#v m#u#b#e K#i | GiU K#uDUv#i i Av#j ev c#vb K#t#Ri Rvq#v# | MYbv BD#uU mg`# Ask Kl#i Ges

MYbvjg-j-K Kvr-Kg^QQvovl Z` web`vm, ubePpb I Zjbvgj-K wePvi I wekkl Ygj-K Kvr Kti | MYbv BDubU thvlM, weqvm, , Y, fVM, tKvb msL`v cRiUf ev tbtMUF wKbv ev msL`vU kb` wKbv ev GKwU msL`v Ab`uU t`K tQvU, eo ev mgvb wKbv Zv hvPvB Kti Ges `yJ msL`vi Zjbv Kiv Qvovl Avtiv wKQyhy³Mh` muqvKj vci ¶gZv ivtL thgb ŐGesŐ, ŐA_evŐ, ŐbvŐ (AND, OR, NOT) BZ`w` mvari Y thſv³K KvrMgn Kitz cvti ev thſv³K mm×vtšitcšQZ cvti | wevfbae`vi cwi tct¶jZ KuvDUvti i GB mm×vš MhY Kivi ¶gZvi dtj KuvDUvi ŐhšMYKŐ-Gi mngxv×Zv Qvovtq hyšwŐ (Logical) Z` wekkl tKi cwi wPvZ jvf Kti tQ | `šZ fivDi t`K Z` GLvfb Avtm Ges Zv m=úY`cšmuvKi Y bv nI qv chš`evi evi `šZ fivDi Avmiv hvl qv Kti | GB Ptm mgq gvBtm cšmmti i Kvhfej xK KZ_ jv ¶Z^a Kvhfej ev gvBtm Acv tiktb fVM Kiv hvq | GK GKwU teimK Acv tikb m=úY`qZ th mgq j vM ZvK Őtgvkb Pm mgqŐ etj | GB mgq b`vtbv tmKtš gvcv nq |

- **tiR÷vi**– KuvDUvti i tiR÷vi m n`Q Avi GK iKti Z` tK>`thLvfb MYvri Rb` Z`_ jv aiv v`K Ges wbt`R tctj MYbv wefvM cvlvq | tiR÷vi m mvari YZ GKvK v`K Ges `i Kvi ntj GK tiR÷vi t`K Ab` tiR÷vi Z` cvlvbv hvq |

2. tgBb tggix ev gj- `šZ fivDi (Primary Storage)

Bbcly BDubU t`K tWUv cštg tgBb tggixZ hvq | tgBb tggix (BvgwMtgU AvKtm) n`Q KuvDUvti i cšvb Z` tK>` thLvfb t`K cšqvRb gZ Z` Lg`šZ Avni Y Kiv hvq | A tK KuvDUvti i GB Z` tK>` wbt`R tctj GK b`vtbv tmKtš (Nano Second) Z` Rvntq t`q | GK b`vtbv tmKtš n`Q GK tmKtšdi GKtkv tKwU fvM i GK fVM |

KuvDUvi Zvi `šZ fivDi tWUv Rgv ivL tZ cvti Ges `qsuqvfvte cšqvRb gZ Zv vbtq cšmm Kitz cvti | cšmm Kivi cte^Q `šZ fivDi Rgv ivLvi KvrwU umicBD tZ Aew`Z cšvb tggixZ m=úv Z nq | i`vg (RAM) I ig (ROM) bvgK wPc hv umicBD ev cšvb Astki mv` mvmKŐ tevW^Q v`K Zv GB cšBgvni `šZ fivDi umvte Kvr Kti | G Qvov K`vk tggix (Cache Memory) bvtg GKwU AZ`š `šZ m=úv `šZ avi Y hšysk AvtQ | GUv umicBD-Gi wFZi A_ev evBti v`K tZ cvti | cšmms-Gi mgq GtZ tctMšgi Ask wekl ev tWUv A`vqvfvte t`K KuvDUvti KvtRi MwZtK Avi I `šZi Kti |

3. e`wks t÷vi ev mnvqK `šZ fivDi (Auxiliary Store)

KuvDUvti i tgBb tggixi ¶gZv mxgZ etj e`wks t÷vti e`v v`K | e`wks t÷vti tWUv eivešii Rb` vqvfvte atj ivLv nq | e`wks t÷vtiK wPi`vqv t÷vi I ejv nq thLvfb Z` cšqvRb Avjvti gvMtbwUk tUc, duc, nvwv` I AcwUK`vj wM` tiKW^Q Kti ivLv nq | cti cšqvRb Zv umicBD-Gi gva`tg tgBb tggixZ Gtb e`envi Kiv nq | e`wks tggix n`Q KuvDUvti i wekvj Z` fivDi |

4. BbclywvBR

th tKvb aiþi Z_ I ubt`R Bbcly wvBRtmi gva`tg KruDUvti cvvrbv nq| Bbcly wvBRtmi mrvth` gvbtl i tevaMg` fvlvi Aqti gva`tg` Zwi ubt`R KruDUvti i wvRUvj mmb`vtj cwieZB Kti KruDUvtiK mieivn Kiv nq| Kx-tevW©gvDm BZ`w` i gva`tgB Bbcly wvBRtmi KivR Pvj vrbv nq|

5. AvDUclywvBR

AvDUcly wvBR KruDUvti i KivRi djvdj Rvbvq| GB dj c_lgZ wv w`ebi gtZv KruDUvti gubti tftm Dtv| wZxqZ wvvti gva`tg djvdj KvMtr gy`Z ntq tewtq Avtm| AtbK t`qti` urKvti gva`tg| djvdj cKvk Kiv nq|

G mg`lAsk_tj v ci`uti m½ Ggbfite h`_vtK hvZ`e`yZK mstKZ cqvRb gZ hvZvqZ KitZ cvti| KruDUvti gta` hveZxq evZP wvbgq nq`e`yZK mstKZi gva`tg| KruDUvti mrvth` tKvb mgm`vi mgvavb KitZ ntj tmB mgm`v mUxq ctmwzK me Z_ Ges mgvavbi Rb` cqvRbxq ubt`Rvejx Bbcly wvBRtmi gva`tg KruDUvtiK Rvbtq w`tZ nq| wqstKi ubt`K tm_wj`ZtZ wvtq mwAZ nq| mgm`v mgvavbi Rb` thM, wvqvm, G aiþi h` wQyKitZ nq tm mUwZ Z_ wj` wqstKi ubt`K`Z t_K ci ci Ptj hvq MYbv wvvtMi gva`tg| Gfite th Povsl dj cvlqv hvq, Zv mwAZ nq`ZtZ| Aetkl wqstKi ubt`K tmB dj c`E mgm`vi mgvavb wvte AvDUcly wvBRtmi ga` w`tq evBti tewtq Avtm| KruDUvtiK Bbcly gva`tg mgm`wv Rvbtq t`lqv ci t_K Povsl dj evBti Ptj hvlqv chsl mg`l Kiv_wj KruDUvti Kti GtKvti`sqvqfite| Gme KivR-Kg©Kti cavbz wqstK I MYbv wvfm|

KruDUvti`Z gvbtl i mvtKvli gZ nvRvi nvRvi`ZS;Btj KUwK mvtKvli AmsL` tKvl (Cell) w`tq MwZ| c`Z`K tKvl OGK0 A_ev 0kb`0 th tKvb GKw Ae`v 0tj Lv0 hvq A`R GK GKw tKvl GK GKw wv msvqZ ntZ cvti| KruDUvti`ZtK KZK_wj tjtKvrb/vrb fvm Kiv nq| GK GKw`Z`vb KZK_wj tKvl w`tq Mov| KZ_wj tKvl wbtq GKw`Z`vb Mov nte, Zv wvfP KitQ H KruDUvti ka``tNq Dci|

GKw KruDUvti`Z aviY qgZv`Z`vbi msL`vi Dci wvfP Kti| GB msL`v mvariYZ 0mktjv0 (2-Gi kw³ 10=1024) A_ev 0tgm0 (2-Gi kw³ 20)-tZ cKvk Kiv nq| GKw KruDUvti`Z aviY qgZv 0064 wktjv ka00 ev mstqtc 64 Word Gi A_ GB KruDUvti`ZtZ 64 x 1024 = 65,536 msL`K`Z`vb AvtQ|

KruDUvti GK m½ GKw ka` wbtq KivR Kti Ges GK GKw ka` GK GKw`Z`vrb msvqY Kti| ubt`Kkv Ges Z_` evBvix c_lvq Encode ev msvKwZK Kti`ZtZ ivLv nq| GK GKw`Z`vrb mvariYZfite GKw ubt`Kkv A_ev Z_` ivLv thtZ cvti|

mZivs c0Z`Kiu vbtK Avjv`vfite mbr3 Kivi e`e`v vKv c0qvRb A`f tKv_vq
vbt`RkV AvtQ, tKv_vq ev Z` AvtQ Ges KLB tKv_v t`tK vbt`RkV A`ev Z` cotZ
nte- KivuDuvitK Zv RvbtZ ntj c0Z`K v`vbi GKiu vKvbr vKv `iKvi | `Szi
c0Z`Kiu v`vbi GK GKiu mjbw`0 Avjv`v 0vKvbr0 (Address) AvtQ, hv msL`v v`tq
bvqKiY Kiv nq| GB AvtW`mi mrvv`h` H vbw`0 v`vbi i`vqZ tWUv mn`R mbr3 Kiv
hvq| tKv we`kI Z` `Szi th vKvbrv v`vbi 0tj Lv0 nte H Z` H vKvbrvZB i`vqZ
nte Ges 0cv0 Kivi mgq H vKvbrv v`vbi t`tKB 0cv0 Kitz nte|

KivuDuvitii `Szi vnmvte mvariYZ tmvgK0vKui I PzK e`i e`envi Kiv nq| vKQyvKQy
`SztZ `vqvfite Z` msi`vY Kiv thtZ cvti | mZivs tm`tjv t`tK i`ayZ` 0cv0 Kiv
thtZ cvti, bZb Z` tj Lv hvq br| Ab`vb` `Szi t`v`t` GKb v`vbi A`f GKb vKvbrv
GKiu Z` g`Q Ab` Z` tj Lv hvq Ges bZb tj Lv Z` msi`vY Kiv hvq|

GZ`vY ch`i th `Szi K_v evj nj, Zv KivuDuvitii vbr`^ `Szfivdi (Main
Memory)| GB gj- `SztZ i`vqZ Z` Avi vbt`RkV we`kI Y Kti KivuDuvi Zvi mg`I
KvRKg`Kti |

KivuDuviti tKvb tc0M0g Kiv ntj tmB tc0M0g me00g KivuDuvitii Af`šhi b `Szi
fivditi Rgv nq| v`vbi BD GB Z` `Szi fivdi t`tK mSM0 Kti Ges cv`v Z` we`kI`Yi
ci Zvi DEi v`vbi v`vbi d`v D`v| G Qvov H GKb DEi KivuDuvi cvi P`v` Z v`vbi
gva`tg Kiv`R Qv`v`v m`e|

th me h`šj gva`tg KivuDuvi Zvi DEi etj tm me h`šK GK K_vq AvDUCy v`vbi BR
evj nq| KivuDuvitii m`t` th mKj mrvv`Kvix h`šj v`vbi v`vbi Zv`i`K tcvi`div
(Peripherals) h`šj etj | thgb- v`vbi BD (Video Display Unit), Kx tev`v, v`vbi,
M`v`K U`v`j U, g`Wg BZ`v` |

Bbcy Ges AvDUCy v`vbi BR QvovI KivuDuvitii m`t` Avtiv GKiu evovZ msh`v` j v`vbi
nq| tmU ntjv evovZ `Szi fivdi (Back up Storage)| GuUj KvR ntjv `iKvix tc0M0g
`vqvfite tiKw`Kti ivLv hv`Z KivuDuvi Ad Kti v`tj I tiKw`Kiv tc0M0g g`Q bv
hvq| gvB`v KivuDuviti 45 RPM B`v tiK`W` gZ t`L`Z d`v v`vbi (Floppy Disc)
bv`g GK iKg tP`K v`vbi evovZ `Szi tiKw`Kti ivLv nq| G Qvov tek KtqKiu
gvB`v KivuDuvitii Af`šti Ggb e`e`v Kiv v`vbi, hv mrvv`h` mvariY Mvb tkvbi
K`v`m`UB KivuDuvi tc0M0g tiKw`Kiv hvq| G mKj tc0M0g Ggbfite tiKw`Kiv nq
hv`Z KivuDuvi tUc t`tK AvZ mn`R Zv cotZ cvti |

KivuDuviti hv vKQytc0M0g Kiv nq, tmU Bbcy v`vbi Ri mrvv`h` `e`v`ZK `ú`tb
i`cv`šhi Z n`q KivuDuviti c0ek Kti | `ú`b tmvRv P`j hvq KivuDuvitii Af`šhi b `Szi
fivditi | KivuDuvi cvi fivq G`K Main Memory ev gj- `Szi evj n`q v`vbi |

gj- `Szi fivditi (Primary Storage) `v` Ask v`vbi | GK Astk Bbcy v`vbi BR t`tK
AvMZ tc0M0g Rgv nq Ges Aci Astk AvtM t`tK v`vbi v`vbi KivuDuvitii v`vbi

~ž Ae GWžKkb

KivRjvc ubqšžYi tcŃMŃg| wŃZxq Astki tcŃMŃguU KivúDUvi ubgžZivivB ~žZ fivĐvfi
fŃi t`q| GB tcŃMŃgi minvth" KivúDUvi Zvi hvezxq KivR-Kg@WKfite Kivi ubt`R
civq|

~žZ fivĐvfi cŃg Ask thLvfb AvgvŃ`i ~žwi tcŃMŃg Rgv nq, ZivK etj i`vg ~žZ
fivĐvi; RAM K_vuU GŃmŃQ Random Access Memory t_ŃK| i`vg ~žZ fivĐvfi Avgiv
hLb Ljx bZb Z_` mĀq KitZ cwi, Z_` coŃZ cwi Avi B"Qv Kitj me Z_` gžQ
tdjžZ cwi | Bbcy wvfvBR t_ŃK AvMZ mg`ŃtcŃMŃg i`vg ~žZ fivĐvfi Rgv nq|

~žZ fivĐvfi wŃZxq Ask, hvŃZ tKivúvbx t_ŃK KivúDUvi cwi Pvj bv Ges nivB tjžfj
tcŃMŃgs fivlv t_ŃK KivúDUvi teva" hvišK fivlvq AbgŃ` Kivi tcŃMŃg wj wce×_vŃK,
ZivK etj ig ~žZ fivĐvi | ig ~žZ fivĐvi t_ŃK Z_ŃK iaycov hvq wKŠ`cwieZŃ Kiv
hvq bv| Read Only Memory K_vuU msuŃB KŃi ROM kĀuU GŃmŃQ| ig ~žZ fivĐvfi
tKvb fiteB bZb tcŃMŃg tj Lv hvq bv Ges tj Lv tcŃMŃg KLb| gžQ tdjv hvq bv| MvŃbi
tiKŃwŃP gZ GB ~žZ t_ŃK tKej wj wce× tcŃMŃgB eri eri cov hvq| KivúDUvfi
civl qvi mŃP Ad KŃi wŃj I ig Gi Z_` AveKZ._vŃK|

i`vg ~žZ wKŠ`fivj vUvBj (Volatile), ZivB KivúDUvfi civl qvi Ad Kitj B gŃžZŃP gŃa"
i`vg-G mĀZ tcŃMŃg ev Z_` gžQ hvq| thgb, Kivj Kžj Uvfi tggix, Guvl GKvU i`vg
~žZ|

gj ~žZ fivY|Wvfi ig I i`vg GB Dfq cKvi ~žZ e`e`vi cŃqvRb AvŃQ| ig hv` i`vg
~žZi gZ nŃZv, ZivŃj KivúDUvi Ad Kitj B mg`Ń ~žZ gžQ thŃZv| Zivci Avevi
KivúDUvi PvjyKitj H weŃkl ubt`Ńki Afite KivúDUvi tcŃMŃgi ubt`R eŃžZ bv tŃi
t_Ńg _vKZ| tmB Rb" ig-Gi ~žZŃK wPi`vqx Kiv nŃqŃQ Ges evBŃi t_ŃK fiv
tcŃMŃgi Z_ŃK mĀq Kivi Rb" Avjv`v i`vg ~žZ fivĐvfi e`e`v ivlv nŃqŃQ|



cv#VvEi gj`iqb: 6.1

A) iPbvqj-K c#kæ

1. Kiv#úDUvi #K?
2. #m#BD #K #K Ask #btq M#VZ?
3. Kiv#úDUv#i i gva`tg #Kfv#e Z_` c#uqvKiY Kiv nq?
4. GK#U Av#bK Kiv#úDUv#i i c#vb Ask_#jvi bvg #j L#y|
5. c#vb tggwi i KvR #K?
6. i`vg I i#gi g#ã` cv_#R` #K?
7. K#U#j BD#b#Ui Kv#e#j eY#v Ki#b|
8. A`mi_#g#U#K/#j #RK BD#b#Ui KvR #K?
9. e`#Ks t#vi ej #Z #K tev#Sb? Z_` #K#mi g#ã` Ges #Kfv#e msi #Y Kiv nq?
10. K`vk tggwi #Z Z_` KZ mg#qi Rb` i#Lv nq?
11. c#vb `#Z I mnvqK `#Zi M#v c#uqv #P#I i mnv#h` eY#v Ki#b|
12. Dcv#E c#uqvKiY ej #Z #K tev#Svq? GK#U c#Y#% Dcv#E c#uqvKiY P# #P#I i mnv#h` c#k# Ki#b|
13. K#qK#U mnvqK `#Zi bvg #j L#y|
14. D#vq# `#Z #K? D`mi Y #b|
15. `vq#fv#e Z_` msi #Y#i Rb` e`e#Z K#qK#U gva`#gi bvg #j L#y|
16. M#v#Z#K/#j# A#k #K ai#bi KvR ms#N#U#Z nq?
17. Kiv#úDUv#i i `#Z #K? GB `#Z#K Kq fv#M fvM Kiv nq? K#qK c#Kvi c#vb `#Zi bvg #j L#y|
18. Kiv#úDUv#i i #eim# ej #Z #K tev#Svq?
19. Kiv#úDUv#i i `#Z#K Kq#U fv#M fvM Kiv hvq? #Kvb `#Z #Kvb Kv#R j v#M?
20. Kiv#úDUv#i i KvR Kivi c#x#Z eY#v Ki#b|

cW 6.2

KwúDuv̄i e“envi

Dʒik“

GB cW tkʒI Avcwb—

- KwúDuv̄i e“envi K tʒʒ̄, tʒvi bʒ ej tʒ cvitʒ Ges
- mʒvRK Rʒtʒi wwfbrʒʒ̄ KwúDuv̄i cʒqM I cʒve e“L“v Ki tʒ cvitʒ|

KwúDuv̄i e“envi Avʒt“i “bw“b Rʒtʒi cʒq cʒZw tʒʒ̄B cʒvi jvf Kʒi tʒ| ZvB eZʒvb hM KwúDuv̄i hM wntmte wPwYZ ntqʒQ| evsʒ vt“kʒKI cʒwʒ i GB bZb cʒvtʒ AskMʒY Ki tʒ nte| MwYwZK cʒqvRʒb KwúDuv̄i Rbʒ ntʒ I AvRʒKi w tʒ Rʒtʒi cʒZw tʒʒ̄ Gi e“envi cwi jʒʒZ nt“Q| GgbwK, AtʒK tʒʒ̄ Gi e“envi Acwi wʒhʒtʒ cʒtʒQ| KwúDuv̄i ewotʒZI “z cʒek Ki tʒQ| Nʒi etmB wcm Awdʒmi gj- KwúDuv̄i mʒ½ hʒ Kʒi Riʒix KivR, tʒv Kiv nt“Q| Awdʒm hvZvqʒZi aKj tʒB| Ggb w b Av i tʒ bq hLb ᶏ-KʒtʒR hvl qvi cʒqvRb dʒi tʒ hvte| KwúDuv̄i gva“tʒB wKʒZ cvitʒQ fivl, A¼ Av i wÁvb| G Ovov ewo etm e“vstʒKi KivR, t“vKivʒi tʒKivKiv meB Kʒi tʒjv mʒe|

Avʒiv cʒg cvʒV tRʒbwQ AvʒbK wʒwRuvj KwúDuv̄i cʒwU cʒvb Ask:

- Bbcʒ tmKkb: Gi gva“tʒ KwúDuv̄i tʒK wwfbrʒZ“ I wbt“R t“l qv nq|
- KʒUʒj tmKkb: Gi KivR Ab“b“ wfvʒMʒi mʒ½ mʒwKfvte thvMʒthvM ivLv I wʒqʒY Kiv, hvʒZ wbt“R gʒZv KivR mʒúw“ Z nq|
- A“wi_tʒwUK Gʒ j wRK tmKkb: GLvʒb wmvw-wbKiv I Zʒbv Kiv nq|
- tggwi: GLvʒb wwfbrʒZ“, wbt“R cʒwZ. msi wʒZ_vʒK|
- AvDUcʒy wʒfvBʒmm: mʒvʒtʒi dj Ges Av i cʒqvRbʒq Z“ hv Pvl qv ntqʒQj Zv KwúDuv̄i gva“tʒ Rwbʒq t“q|

G, tʒvʒK KvʒRi wʒwʒZ wfvM Kiv ntqʒQ- Zvi gʒtʒ GB bq th, GKUv Ask KʒUʒj, Av i GKUv Ask tggwi | Giv wʒtʒ wʒtʒ Rʒotʒ_vʒK| tggwi, KʒUʒj, A“wi_tʒwUK j wRK BDwbUʒK GKmʒ½ ej v nq tmʒUʒj cʒwʒms BDwbU (wʒwBD) hv KwúDuv̄i cʒY|

ZvovZwM MwYwZK KivR Kʒi t“l qvi Rb“ KwúDuv̄i D“e ntʒ I eZʒvb Gi kZKiv 80 fivM e“envi nt“Q AMwYwZK KvʒR| hvʒvK, wÁvbK Mʒel Yv I wÁvb mʒúwKʒ KvRKg©, e“emv-ewYR“, mi Kivix kvmbKiv© wʒí, thvMʒthvM e“v, hvbeirnb, wKʒv, wPwKrmv cʒwZ. tʒʒ̄ GgbwK tLj vʒjvi Avmʒi I mʒʒZi RMʒZI KwúDuv̄i cʒqM mʒk evotʒQ| bivri Kg KvʒR th me tʒveʒU i e“envi nt“Q, th, tʒjv wʒqʒY I bKkiv Zwi Kivq KwúDuv̄i Dʒj wʒthvM“ fʒgKv AvʒQ| AvʒbK wÁvbʒi AMwZi cʒZxK th gʒvKiv GgW tʒwʒ

Avrthvb, KuvuDUvii mnvnh` Qvov Zv mae ntvb v| th AtUvtgkb ev` qsuuqZv wevfbae KivRKtg9 YMZ gvb emotq w`t`Q, chwvi Z Kti w`t`Q gvbjyi KvRi cwiwa, tmB AtUvtgkthi c0Ytk>`nj KuvuDUvi |

GKK_vq KuvuDUvi AvR RbRretbi me`ti Abg0ek KtiitQ| GB htšj mnvnh` t`tki wevfbaeAAjt Avdm-Av`vj tZ IqvW0mims-G wPwvCt gyY, Z_` msi qly I evtRU c0Yqb Kiv ntv`Q| e`emv-emvYtR`i tqtit ctyi`i c0Zw`thi muq-wemq, Pwn`v, Drcv`b gvb wqšy, Drtmi e0všl wevq ceffim, cyvMviti ZivqYKfivte grtzi Ae`v, wmv msi qly I Zvi LvZl qvix wetk0Y, `qsuuq wbf9 AvWU wivt0U0I e`vtj Y mxU c0Yqb, e`vstki wmv wkvk, tctbi Avmb msi qly BZ`w` G htšj mnvnh` Kiv ntv`Q| tiwvI-wvrf, wvBwfs jvBtmtyi Uvkv M0Y Kiv ntv`Q| exqv c0Z0vth c0Zw`b exgvi wkw`I Rgv tbiqv, exgviixi Ftyi Uvkv c0vb, FY cwitkvitai wkw`I M0Y, exgvi Uvkv cwitkva, etkqv wkw`li wmv ivLv, eU ntq hvI qv exgv bZb Kti PijyKiv ntv`Q| 0cwv`K gwmb0 vrtg LvZ 0tmwU Kvw0 w`tq hLb ZLb A_`0tZijv mae ntv`Q| wvCvU0gUvj t`v`ti evitkvwi mnvnh` tKvitePv, tWUv Kgyv0Kkb, B-tgBj, ftqm tgBj t0tyi KvR KuvuDUvi e`euZ ntv`Q| tkqv evRvi ,tjtZ IqvBW Gvi qv tBU qvK0(Iqv) Ges tjvKj Gvi qv tBU qvK0(j`vb) wmv`g c0Z0bi dtj wekji th tKvb`vthi wevbtqvMKvix tkqv evRviti wevbtqvM KitZ cvi0Qb| tKvb c0Z0vth Kgvixi msLv, Zv`i Kge`xwZ, `wqZ; Kgv0Uv, Kge`i wZ, Qv0Uv, Abg0w`zi nvi, g0vthvM, `qZv, e`v0MZ Z_`vejx, Kge`rciZv BZ`w` Z_` wek0tyi gva`tg k0k0ti e`v0MZ Ae`v hvPvB Kiv nq| Kj KviLvq w`vZ KuvuDUvi Zvi `qsuuq tmYi e`v` 0viv wevfbaeDvE M0Y Kti| Givkvi kni ,wj tZ evqy t`tyi Ab`Zg KviY ntv`Q Mvov t`tk wvM2 t0vqj j 0`bi GKwU tKvuvv0x KuvuDUvi wvfiEK GKwU Ujv0KU D`v0eb KtiitQ evqvK cwi gY`w`Z ntv`Q, evq0Z wK cwi gY wvlv`3 c`v_0vM2 ntv`Q tm e`vcitai AvMvgx KtqK e0ti GKwU aviv GB Ujv0KU e`enviti gva`tg cvl qv hvte|

Ki, we`y, M'v BZ`w`i vej `Zvi Kiv ntv`Q KuvuDUvi w`tq| KuvuDUvi tkLvtZ cvti bZb tKvb wvq Ges fivv| wkvvvt0t wkvvq Drcv`b e`q Kvhvvi Zv, wkvvvgj-K Mtel Yv I Z_`vejx msi qly, cixqvi gvK0U `Zvi, fiv`cixqvi djvdj c0vkv, jvBteixtZ eB tjbt`b I tidviti Y eBtqi mUvb BZ`w` KvRi GwU e`euZ ntv`Q| G Qvov gnvk0b` Mtel Yv, iy0KŠkj, tUvj thvMvthvM BZ`w` tqtit KuvuDUvii D`4j fivel`r m0v0Z| Ggvik wekji wevfbaeM0viti i`qZ eB, mvq0vK Ges weAvvfiEK Z_`mn wevfbaeZ_` KuvuDUviti AvR mdj Zvi mvt_`msi qly Kiv ntv`Q| Gi dtj Mtel Yvi Rtb` KuvuDUviti gva`tg Z_` mieivtn GK bZb hv m00 ntq0Q| B`vbs Avevi tW`Uc wvmtK wvW-i`tgi mvt_` GKwI KiY Kti Kgc`v± wv`v-wvwm vrtg evRviti t`Lv hv`0Q| Gme wvwm I wvW-ig GZw`b Avjv`vfvte evRviti wevq nZ| eZ0vth tW`Uc wvmtZ `vKtQ we`v-Bb wvW-ig wvBf hv c0Z Z_`, wP` I m0xZ cv0 BvA wvWv gta` msi qly KitZ cvti| wvW-i`tgi A_`0j - Kgc`v± wv`v-wv-I biv tggvi (Compact Disk Read Only Memory)| Gme wvW`i Z_` t`Lv I tkvbv hvq| G ,tjv c0Z`KwU 680 tgMevBU tWUv A_`0 Avov B q c0v tggix avitb m`qg| dtj Drcv`b evx` cvt`Q I Avq evotQ|

cwi evt`ii mKj m`tm`i kvixiK Ae`vi DVvbrgvi Z`I KivúDUvi AvcbvK RvbrZ
cvti | weivU emoi emZ, d`vb, Iqniks tguktbi mBP ubqšY KitZ cvti KivúDUvi |
tKvb Nti cvLv Pj tQ, Ute cwb coťQ wK bv, `eVK Nti Ah_v emZuU Rj tQ wK bv, Zv
KivúDUvti t`tL, KxteW`w tQB ubqšY Kiv m`e | Rvcvrb GLb Avdm t`tK tUvj tdiv
Kti KivúDUvi tK etj w`tj B ntjv, Avcb Avdm Z`vMi AvtMB Kkvti fiv ivbwe nevi
mstKZ cvteb, wK mgťq Gqvi KivDkvi Ab ntq NiUv VvDv Kti ivLte | KivúDUvi Gme
tŷt`R Rvtebi mv_x ntq I tV |

c`KŠkj ubgŷ cwi Kíbv Z_v wVRvBb-Gi tŷt`R KivúDUvi Amva` mtab KitZ cvti |
GKRb WdUmgb GKwU Pvi Zjv emoi wLz bKkv cŷqb KitZ 6 Nuv ntZ `ia Kti
10/15 w`b e`q Kti v`tKb | wKŠ KivúDUvi G KvRUv gvĪ `yGK Nuv gta` mŷcYfite
m`uv`b Kti t`q |

weAvtbi DrKtIŷ GB h`M KivúDUvi GLb wPivKrmťKi fvgKvq AeZvYŷ Avcb hv
cvi tmbvj KivúDUvti CHES (Computer Health Enhancement Support
System) aiti tKvb tBU qvK`mshŷ Ktib `v` m`u`wKZ AťB mgm`vi B mgvavb w`tq
w`te KivúDUvi | Gi gva`tg e`envi Kvixiv AťB Wv`vix c`k`ev DEt`ii A`v`Ki
w`lq, t`v t`tK gvŷ tctťQ | G aiti c`x`zi gva`tg w`b-i`wĪi c`ZuU g`ťZ`v`i`Mxi
gťb ntZ cvti Zvi m`v`B GKRb Avf`Á Wv`vix itťQ Ges tm th tKvb g`ťZ`v`w`f`b`e
mgm`vi `iaZcY`civgk`ťctZ mŷ | Dbz w`tki AťBtKB GLb wPivKrmv mspvš,
mdUI qvi t`v`Mg Ges Ab-jvBb, tWUvteBR Avi m`v`cU`M`c, t`v t`tK Zv`i `v`
mŷŷlvq e`e`v`cĪ m`Mh KitiQb, hv wK bv wKQv`b AvtMI wQj Kíbv AZxZ | GB bZb
Uz, t`v t`v`Mx`i Av`k`wPivKrmv tmev c`v`b KitiQ |

**KivúDUvi tK wK
evj`gvb ej`teb?**

KivúDUvi AťB KvR KitZ cvti | cwi Pjv bv m`ťctŷŷ wekvj wekvj RvUj Av` KitiZ
cvti | `w`b`b wKí mŷ KitiZ cvti Avil AmsL` KvRvvi Zv eYŷv Kiv hvq | wKŠ Gi
cĪil GKwU KivúDUvi tK wK evj`gvb ej v hvte? m`eZ ej v hvte bv | Kvi Y KivúDUvi Gi
w`R`ťKvb mRbKxj Zv tB | hvŷ w`f`ĪK wKQy`ťkĪ Y cwi Kíbv ev Avil Ab`vb` wKQyKvR
KitZ cvti | wKQyKQye`Avb Aek` KivúDUvi ev GB RvZxq hš; t`v tK hvšK evj`m`šZ
etj tQb | GB evj`g`Ev gvbtĪi evj`g`Ev ev gbťbi tťq AťBKUv w`f`b` gvbtĪi evj`g`Evi
gťj tPZbv I AvMh KvR Kti Zv GB hš; Abz`w`Z |

**Avgt`i wK Kiv
DvPZ?**

RvZxq DbzťZ weAvtbi GB bZb Avme`vtii Ae`vbťK ZjvšZ Kivi Rb` KivúDUvti
m`v` Z` w`lgbťqi gva`g w`tmte gvZf`vvi e`envi Avek`K | evsjv e`envt`ii dtj
KivúDUvi tK Avgt`i Rvtebi c`ZuU tŷt`R e`envi Kiv m`e | me`ťi evsjv e`envt`ii
AťB w`ťbi c`PóvťZ Gi Ae`vb nte h`MvšKvix | Bst`i`RťZ w`f`ŷ, mnR Ges ZivvZvno
tjLv hvšK th mKj mŷ`aw` w``gvb, evsjv fivlťK me`ťi e`envi Ges mKťj KivQ
MhYxq Kivi Rb` evsjv e`envt`ii tŷt`R I tm mKj mŷ`aw` ev`evqťb mťPó ntZ nte |
KivúDUvti evsjv e`envit`K `iasvĪ evsjv IqvW`c`m`ms-Gi MvDi gta` mŷgve`x Kiv
Avgt`i DvPZ nte bv | KivúDUvti evsjv e`envi ejťZ Avgt`i KivúDUvti w`ťqj UvBg
e`envi, KivúDUvi thvMťhvM, evsjv Aŷi mbr`KivY, KivúDUvi tBU qvK`c`f`w`ZťZ |

evsj v e'envi i cᶒqvRbxqZv eᶑtZ nte Ges tm e'vcvfi mᶑPó t_ᶑK Avgvᶑ iᶑK G_ᶑZ nte|

KivúDuv i Z_ cᶒyᶑ

KivúDuv i kivᶑkvj x Ges e'ecvK e'e'vcvfi mᶑvqK | Z_ cᶒyᶑ i h_v_ᶑGes mgᶑqvPZ cᶒqvM MvZ I mᶑvxbZv evᶑᶑᶑ e'e'vcv i cᶒkvmbK `ᶑZv evx KᶑZ cvfi | KivúDuv i nj Z_ cᶒyᶑ i mᶑᶑᶑK>`ᶑ Zᶑ_ i e'e'vcv GKvU t_ᶑki A_ᶑᶑvZK AMᶑMvZ mᶑvᶑb AZ`ᶑcᶒqvRbxq fvgKv i vLᶑZ cvfi | Drcv`ᶑbi kZᶑᶑᶑ thgb- fvg, kᶑ, gj-ab, cᶒyᶑ BZ`v i gv b Dbᶑᶑ Kᶑi KivúDuv i tgvU RvZxq Drcv`b evx KᶑZ cvfi |

KivúDuv i vᶑᶑv`vb

KivúDuv i e'envi Kiv x gvᶑB vᶑvMv tMg (Video Game) mᶑᶑᶑKᶑRvᶑbb | KivúDuv i i gvaᶑᶑ tPvi-cvᶑk tLj v, Mvᶑᶑ WᶑBvᶑs, vᶑgvb Pj b v, ᶑvᶑ Kᶑi vᶑgvb fcvvZZ Kivi tLj v vKsev hy-hy tLj v, ᶑj v tmᶑKᶑj nᶑᶑ hvᶑ"Q | Mᶑᶑᶑ. Gvᶑᶑᶑb I t_ukvᶑ Bᶑᶑᶑᶑ c_ aᶑi KivúDuv i Pᶑj GᶑmᶑQ GLb Pj vᶑᶑᶑᶑ AvᶑObvq | vᶑᶑ Ae cvmᶑᶑ, vᶑᶑᶑᶑ, WvBbvᶑᶑ. , nvUᶑAe Pᶑᶑᶑ, t_úm tKvᶑᶑ ÷ BZ`v tᶑᶑMᶑᶑᶑ vᶑj Pj vᶑᶑᶑᶑ Kᶑᶑᶑᶑᶑ |

mᶑvDᶑ Kivᶑ, gvᶑᶑᶑᶑᶑᶑ BZ`v i Kᶑ vᶑY mᶑvK Pj vᶑᶑᶑ vᶑᶑᶑᶑ mᶑᶑᶑᶑᶑᶑ KᶑZ cvfi KivúDuv i | KivúDuv i cᶑZ DbvZ mᶑvᶑᶑi dᶑj Mᶑᶑᶑ. vᶑRvᶑB Av i tKv b mgmᶑvB bq | vKᶑᶑᶑ AvM chᶑᶑ fᶑᶑi Qvᶑi fᶑᶑZK i `k_ ᶑj v cᶑᶑᶑ vKsev tgKvᶑᶑi gvaᶑᶑ Kiv nᶑZv | GᶑZ `xNᶑmgᶑ ᶑj ᶑM thᶑZv Ges e`q nᶑZv cᶑᶑ | GLb KivúDuv i B G mg`ᶑKiv R Kᶑi |

gvᶑᶑᶑᶑᶑᶑ cᶒyᶑ e'envi i mᶑᶑᶑ Av i AvZMvZkᶑj Bᶑvᶑᶑᶑ e'e`v Pj vᶑᶑᶑᶑ qvi ci KivúDuv i i Kiv R eᶑ_ᶑY teᶑo tMᶑQ |



cvᶑvᶑi gj`vᶑb:- 6.2

A) i Pbvᶑj-K cᶑᶑ

1. vK vK Kiv ᶑY KivúDuv i i e'envi GZ e'vcK?
2. vᶑᶑᶑᶑᶑᶑᶑ KivúDuv i i cᶒqvM vᶑᶑᶑ Avᶑj vPbv Kiv b |
3. mᶑᶑᶑᶑᶑ Rvᶑᶑ KivúDuv i i e'envi i dᶑj mᶑ cᶒZᶑᶑᶑᶑ vᶑᶑᶑᶑ KᶑᶑKvU v`K vᶑᶑᶑ Avᶑj vPbv Kiv b |
4. e'emv-emvᶑᶑR`i tᶑᶑᶑᶑ KivúDuv i i cᶒqvM vᶑᶑᶑ Avᶑj vPbv Kiv b |
5. KivúDuv i e'envi i ᶑiᶑZ; Avᶑj vPbv Kiv b |

ḡ Ae GW#Kkb

wj | úvBW iáj i ḡ Ask eo GKú Pl ov t-áj i gvtS GKú Kvúv LúRi gta emi#bv
_vtK miæt-j | miæt-j UvtK H LúRi gta eo t-j Uvi Dci G cvk I cvk úvBW Kfi
mi#bv hvq | GB iáj th DEi cvl qv hvq Zv t-áj i Mvtq tj Lv t-#K co#Z ntZv | úvBW
iáj K#qK ermi Av#Ml tek Rb#cú #Qj |

1642 mvtj gvĪ 19 eQi eq#m d#tYi M#YZÁ, c`v_#e` Ges `vk#K teR cv`vj cĪg
mdj h#šK K#úDUvi `Zwi K#Z m#lg nb | cv`vj G hšjU `Zwi K#i#Q#j b gj-Zt Zvi
everi cĪqvR#b | KviY Zvi ever ZLb miKvix Ki Auct#m P#K#x K#Z#b | #ewf#eKi
#bY#qi Rb` tm mgq Zv#K #eivU #eivU th#M Avi #etq#M Kivi K#R e`-#vK#Z ntZ |
everi K#Ri P#C Kgv#ZB cv`vtji GB A#e`vi | G#U Gi ce#Z# me_#j h#šK
K#úDUvi t-#K Avj v`v cĪ#Zi #Qj |

cv`vtji hšj c#vb Ask #Qj K#qKú `vZlqv# P#Kv, A#bKúv #Mq#i gZ | GB
P#Kv_#tjvi tgvU `kú Kfi `vZ, cĪZ `#Z 0 t-#K 9 msL`_#tj# Lv #Qj | tgvUi M#oi
gvBj #gU#i th b#vZ, A#bKúv #mB b#vZ#ZB `Zwi ntq#Qj hšjU Ges G hšjU tP#v#v
#Qj AvR#Ki #b#i tgv#bK`vj tW`-K`vj K#j U#i gZ | c`v`vtji G hšj_#tq tKej
th#M I #etqv#Mi K#R nZ etj e#v#R`K mdj Zv AR# Kiv m#e nq#b |

1833 mvtj K#úDUvi R#Zi m#gv#v c#v#i Z K#Z G#M#q G#j b #e#Uk M#YZÁ P#j R[©]
e`#teR (1792-1871) | e`#teR tckvq #Q#j b tK#R #ek#e`vj#qi Aa`vcK | #Z#b
A#e`vi K#i#Q#j b B#vZ#v# #eL`vZ `#j K#úDUvi, #M#d#i Y B#Á#b ev #etq#M Kivi hšj
Ges ÁA`v#v#j #Uk`vj B#Á#b ev #etk#l Yx hšj #Kš` hšj `#j GKú#Kl #Z#b m#úY#j#
#tq th#Z cv#b #b | `#LR#K ntj I, #mB mgqKvi Z#b#vq e`#teR #P#š#q I tPZ#v
#eK#t#K #Q#j b A#bK A#M#v#x |

e`#teR e#š#Q#j b GKú Kv#R#i# M#v#hšj`Zwi K#Z `iKvi:

- GKú h#šK tggix ev `#Z#v#v#i thLv#b tWúv I djv#dj Rgv_#K#e;
- GKú A`#v#_#g#Uk B#b#U thLv#b th#M, #Y BZ`#v` K#R Kivi #b#`R cv#Á K#W#P
gva`tg t`lqv n#e mKj cĪ#v#i mgva#b cĪ#qv#KiY Kivi Rb`;
- GKú K#U#j B#b#U, hv #Mq#i I `#di gva`tg tWúv Ges djv#dj tggix ntZ
A`#v#_#g#Uk B#b#U t#Y K#Z cv#e;
- B#cy I Av#Ucy B#b#U hv#Z M#v#v K#h#P ci DEi#v# Q#cv# ntq #e#i#q Av#e# |

e`#te#Ri G c#iK#i#v# tm h#M `iayZ#E# m#gv#x #Qj, G hšjU #Z#b `Zwi K#Z m#lg
n#b#b | Gi KviY `#j; cĪg KviY nj ZrK#v#j b c#v# #Zgb D#z# #Qj #v hv #tq
e`#te#Ri gZ cĪZ#v#i K#P#K cĪZ#dj b N#v#Z cv#Z#v# | #Z#x# KviY gv#ly ZLb G a#b#i
GKú B#Á#b#i e`#v#v#i D#m#K #Qj R#v#Z#v#v# | tm Rb` e`#te#Ri tm `c#e`c#B i#q t#M#j |
Zey#v#te#Ri GB h#šK#v#ix #P#š#i #v#v#v# Ges cĪP#v#i Rb` Z#v#K#B Av#v#K K#úDU#i#i
R#K ej#v#nq |

1854 mvtj RR^oejy (Georg Boole) GK bZb aitbi hʹyʹibô MmYwZK c×wZi (Arithmetical System of Logic) K_v wPšl Ktib| tm me hʹyʹ w elqK mgm'vi wmxvšl evBbwi msL'v c×wZ A_ŕ mZ'wq_v- GB `B Ae`vi mgštq mgvaib mæ`e wQj | GtKB tK>`a Kti wZwb Awe`vi Ktib GK aitbi Gj tRei| GB Gj tReitKB evj qvb Gj tRei ejv nq| cieZʹ mgštq KvdR mibb brtgi GKrb QvĀ `e`yZK eZŕ Ges evj qvb Gj tRei mæúK^ot`LvZ mg_`nb| GiB Dci wFwĒ Kti Mto DřVtQ KæúDUvtii Kih^exwZ|

1938 mvtj Bôk`vbb ixtj mBPs mmmKŕUi wek'k'Y Kitj b evj qvb Gj tRei mrvvth` wbtq| ōixtj mBpŌ Gi `B Ae`v- mBp tLij v A_ev eŪ Kiv A_ŕ we`y' cēvvnZ nt`Q A_ev nt`Q bv| ōixtj mBpŌ Gi ga` w`tq wey'r cēvvnZ ntj mBp eŪ nq Zv bv ntj mBp tLij v _vtK| GB mĀ aŕi wWvRUvj mmmKŕ ev jwRK mmmKŕ-Gi tMvoicĒb nj | GB jwRK mmmKŕ-Gi DbwZ I AMŌwZi dj wWvRUvj Btj KUŭbK KæúDUvi |

cŭg cŕbʹ Pij ŕ e`vtetRi `cŕK cŭg ev`é i/c w`tj b nrvfŕw'wek'ie`ij tqi nl qvW^o AvBtKb| wZwb AvB.we.Gg. tKvæúvbxī mñthvMvZvq 1944 mvtj `Zwi Kitj b cŭ_eri cŭg wWvRUvj KæúDUvi | gvK^ol qvb brtg GB KæúDUvi w BwZnvŕm weL`vZ ntq AvtQ| G hšjU `Zwi Kitj zj tMwQj AmsL` `e`yZK ixtj Avi tMvQv tMvQv Zvi | hšjU wQj mgprr Avi Zvi MwZi wQj `g | ZvB Zvi cŭqvM mæbevl wQj LgB mxiqZ Zey tm mgštq AtbK RvUj MmYwZK tUvej `Zwi Kiv Qvovl G hšj mrvvth` wŌZxq wek'htx'i mgštq Kvgvŕbi tMvjv, tŕŕcbv`i BZ`w`i MwZc_ Kŕl tei Kiv nZ| GwUB wQj meŕŭg `qsvŕq KæúDUvi | cieZŕZ Aek` WrtqvW I UřtqvŕWi Awe`vti i dtj ōgvK^ol qvbŌ Gi Amŕeav `Ĥ nq|

cŭg Btj KUŭbK KæúDUvi `Zwi ntqvŕQj 1946 mvtj AvtgvwKvi tcbvŕmj fvbqv wek'ie`ij tq| GKvU^o Ges gPij G hšj; `Zwi Kŕi Zvi bvg w`tqvŕQj b ōBibqvKŌ (Btj KUŭbK wbdřgvw K'vj BbvUřMŌi GŌ K'vj Křj Ui) ōgvK^ol qvbŌ Gi Zřbvq BvbqvK KZUv DbwZ wQj Zv GKUv D`vniY w`tj B ešv hvte| GK NsvUvq BvbqvK th MYbv Kitj cvi Z tmB KvR Kitj ōgvK^ol qvbŌ mgq wBZ GK mBvŕ| BvbqvŕKi I Rb wQj 30 Ub Avi RvqvMv `Lj Kŕi wQj 1500 eMŕŕ| G hšjUřZ 19,000 WrtqvW I UřtqvW evj; e`envi Kiv nq| G Qvovl 70,000 tiwR÷vi 60,000 mBp I 10,000 K'vcvmmUi mšthvMvZ wQj | GwU Pij vtZ 130 wKřj vl qvU we`y' kv^oi cŭqvRb nZ| cŭZ tmřKřŌ 5000wU MYbv mæúbæKitj mŕŕg ntj I GwU tKvb Z_` avi Y Kitj cvi Z bv| GB hšj; wŌZxq wek'htx'i mgštq tŕŕcYvt`j MwZc_ wbaŕřtYi KvřR e`envi Kiv ntqvŕQj |

G cŕřbʹ KæúDUvtii gvařgb tçŭŕŕŕg I tçŭŕŕŕgi fvlv e`envitii mPbv ntqvŕQj | G mgq Aek` tçŭŕŕŕgs Kitj nZ hmvšK fvlvq, hv kb` (0) I GK (1) Gi gvařgb web`-ŕ|

wŌZxq cŕbʹ 1951 mvj t_řK 1958 mvj chšřmgqKvj řK KæúDUvtii wŌZxq cŕbʹejv nq| KæúDUvtii wŌZxq cŕřbʹ mPbv ntqvŕQj Btj KUŭbK evřj; cwi etZ^omij W t÷U Uřbvŕ÷vi e`envitii gvařg| UřtqvŕWi tPřq Uřbvŕ÷vtii mŕeav AtbK teŕk| GřZ cřo hveri gZ wdj vtgU tbB; GwU AvKřti tQvU, `řZ Kgŕŕg, we`yZ LiP Kg, teŕk Mig nq

~ž Ae GwžKkb

bv| GB Ušbŕ÷vi tK UšqvšWi gZ mšP ũnŕmte e'envi Kti th me KŕúDUvi žZwi nj Zŕ' i bvg t' l qv nj ũZxq cRtbš KŕúDUvi |

ũZxq cRbš t_tKB KŕúDUvti nvB tjtj j'vs_tqR ev tcMšgs Kivi mnR fvlvi e'envi i iæng| nvB tjtj j'vs_tqR tK hŕšK fvlvq cŕieZš Kiž KŕúBjvti i D'ŕe nq| Ušbŕ÷vi e'envi Kivi dtj ũZxq cRtbš KŕúDUvi cŕg cRtbš tPtq AvKvti tQvU ntq hvq| nvB tjtj fvlv ũnŕmte diU'vb (FORTRAN), tKŕtej (COBOL) D'ŕeZ nq|

ŕeÁvxiv G ũbtq mšš _vKž cvi tjb bv| Zviv tPŕv Kiž j'vMtb ũKfŕte GKŕak Ušbŕ÷vi, tŕR÷vi l K'vcŕŕŭi ŕtq žZwi GKŕU tQvU mnKšK GKŕU Ušbŕ÷vti i gZ tQvU Kti tdtj hvq| ŕeÁvx' i ũbij m cšPŕvi dtj Aŕ' ŕtbi gŕa' Mšo DVj žZ' GKŕU mnKš| GB žZ' mnKšK BŕUšMšUW mnKš ev AvBŕm (IC) ejv nq| GB AvBŕm e'envi i dtj KŕúDUvti i AvKvi Avil tQvU ntq tMj | ZLb KŕúDUvti i žZ' evotž ũMŕq Zvi gvc Avil eŕav ntq ŕwvj bv|

ZZxq cRbš AvBŕm žZwi Kti ŕeÁvxiv t_tg _vKtjb bv| Zviv AvBŕm A_ŕ Btj KŭbK eZšK mž t_tK mžZi Kti tZvj vi Rb' MŕelYv Pjvtž _vKtjb| GfŕteB žZwi nj ŕFGj GmAvB cŕŕZ- hvi cŕj bvg nj šŕfŕi jvR' t' j BŕUšMšUW | Gi mnŕth' GLb GKŭv tMŭv KŕúDUvti tK cŕKŭ K'vj Kž Utii gvc žZwi Kiv mšš ntqš| GB cRtbš KŕúDUvti tK ejv nq ZZxq cRtbš KŕúDUvi |

PZZ cRbš ŕgŭb KŕúDUvti e'ŕcK cšj b, jvBb ŕcŭvti i Avŕeŕe, BŕUšMšUW mnKšŕŭi eŭj e'envi BZ' ŕ Dbŕtbi gva'tg PZZ cRtbš AMŕŕv| G cRtbš tMŕvi ŕtK KŕúDUvti i mŕt_ gvDm mšŕŕvRZ nq| WMjvm GŕjŕeU' 1968 mŕtj mŕbdŕŕmŕKvi GK Kbdvti t' Kx-ŕeŕŕŕ cŕkvcŕmK Bbclj ũŕfŕBm ũnŕmte gvDm D'ŕeŕtbi K_v tNvl Yv Ktib| hv cieZšZ e'envi Kvi x KZŕ. ŕecjŕte mgv' Z nq|

G cRtbš tej j'ŕeŕi ŭvi i šŕb KŕúDUvi ŕeÁvx KZŕ. D'ŕeZ nq UNIX Operating System| tcMšgs j'vs_tqR cŕmKj l (PASCAL) G cRtbš B Dcŕvi | GfŕteB Pjtž _vtK KŕúDUvti i D'ŕivEi DbŕZ| G cRtbš KŕúDUvti i šZ D'ŕeZ ntž _vtK|

eZŕŭb hšMi KŕúDUvi mŕgt'ŕ' i GK'Qŕ AvacŕZ ŕej tMŭn Ges cj A'vj b 1975 mŕtj gvBŕŕvmdŭ Kŕcŕikb cŕZŕv Ktib| Giv šŕb ŕeŕfŕe tKŕúvbx KZŕ. cšZKZ. KŕúDUvi mgŕni Rŕb' ŕeŕfŕe ŕtbi mdŭl q'vi žZwi Kiž i iæKtib, gvBŕŕvmdŭ ũŕ' Acŕŕi ŭs ũnŕ÷g (GgGm-Wm MS-DOS) žZwi Kti Giv ŕecj RbŕcŕZv ARŕb mŕŕg nb|

cÁg cRbš 1981 mŕtj RŕcŕtB AbŕšZ tPŠ' ŭ t'tki KŕúDUvi ŕeÁvx' i tNvl Yvq 1995 mŕtj i ci t_tK Avŕe'Z. KŕúDUvi mgŕtK cÁg cRtbš KŕúDUvi ũnŕmte

AvL`vqZ Kiv nq| weÁvbx`i aviYv G cRtb#i KivúDUvimgr Kúlg eyx m`ubent| G cRtb#i KivúDUvimgr gvb#i i fvlvtK ubR`^fvlvq ifcvšli Kti Kihfej x m`uv`b KitZ cvi te etj I weÁvbx`i aviYv| svLSIC e`eüZ cÂg ev fivel`r cRtb#i KivúDUvimgr cüz tm#K#đ `k t`_tK GKkZ tKvU jRK wmvšl MhY KitZ cvi te etj aviYv Kiv n#Q| gvb#i i b`vq G cRtb#i KivúDUvimgr ubR`^wePvi eyx cüqvR#bi gva`tg we#k#Y KitZ cvi te etj I Avkv tcvlY Kiv n#Q|



civv#i gj`vqb: 6.3

A) iPvqj-K c#æ

1. A`veivKvm wK?
2. AvavbK KivúDUv#i i RbK tK?
3. `eivkó`mn weifb#cRtb#i KivúDUv#i i Kiv#xwZ Avtj vPbv Kiab|
4. Pvj # e`v#eR tK wQ#j b? KivúDUv#i i AMhZi tcQ#b Zvü Ae`vb Avtj vPbv Kiab|
5. cü_g B#j KUvb. KivúDUv#i i biv wK? tK, tKv_vq Ges KZ m#tj GB KivúDUvi`Zvi K#i b?
6. mst#t#c tcvMü_g tKšktj i weeZB Avtj vPbv Kiab|
7. RR#ej tK wQ#j b? KivúDUv#i wK Ae`v#bi Rb` wZvü cvi wPZ?

i`vg I igtK Pjyev eU Kivi ubqšy mmiK| GB umicBD cjiUvB eZvrb GKuU gvT umij Kb wPc Z_v gvBtμvcmmi w`tq `Zwi | KivúDUvi tK th me Bbdi tgb I ubt`R t`lqv nq tmiU cU`tg GB umicBD tZ tXv tK| Zvici GLvb t`tK KivúDUviti ubw`R RvqMvq cmmms-Gi Rb` hvq| KvR tkl ntj umicBD djvdj mslMh Kti AvDUC tU cvw`tq t`q|

GKuU AvajbK gvBtμvKivúDUviti eK WvqMög Avktj mntRB tevSv hvq umicBD wKfite mg`l KivúDUvi tK ubqšy Kti Ges GKB mt½ wKfite ig G i w`qZ Firmware tCMMög, ubqšy Kti mg`l KvR Kwi tq tbq|

GKuU AvajbK KivúDUviti eK WvqMög

wKfite wefbaetcwi tclwi qvj m t`tK C, P, U G Z_` hvZvqvZ Kti Zv ubtgè Qie tZ t`Lvb ntq tQ|

1. umicBD (tggi x, KtUj , A`vwi_tgUJK j wRK BDubU ug tj umicBD)
2. Kx tevW®
3. Ab`vb` Bbcly wWfvBm
4. ig
5. tm tK Dvix
6. i`vg
7. wfwWBD
8. wCÜvi
9. w`úP&w`štnvBRvi
10. g`Wg|

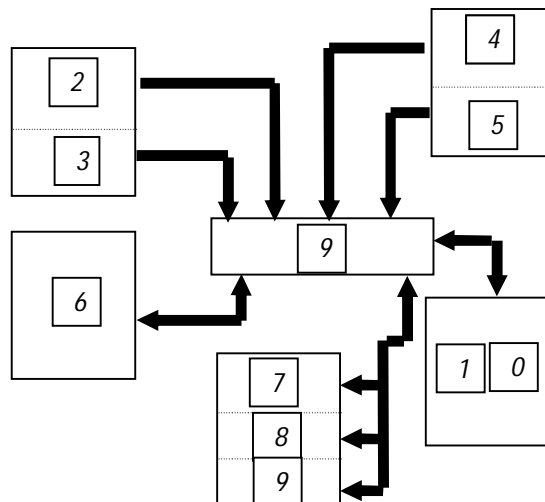

gvBtμvcmmi (Microprocessor) ev qjz`c`μqvKvi K

qjz`Kwzi GKuU gvBtμvcmmi wPc Avgv`i Pjy -Pj b, AvPvi -AvPi Y, iaP I tPZbvtevamn msmv`i i hveZix KvRKg®, msev` Av`vb -cÜvb, hvZvqvZ e`e`v, Awd tmi KZ`Kg`BZ`w` m`úY`f`c cvtè w` tqtQ| Qie i G wRwbl wU GKuU ÖgvBtμvcmmi wPcÜ| GuU nvRvi nvRvi qjz`wZ`qjz` Btj KUwbK mmiK`Ui Avevmfug hv KivúDUviti KvRKg`K ubqšy Kti | GB wPc Btj KUwbK m`k`i i Avgj -cwi eZ`B mrvab Kti tQ| wefbaetšcwiZ, mvrmi Ävg I tLj bvq GB wPc e`env`i i c_ Awne`vi Kti tQ| Giv GLb meP`| MmwtZ, nvZ -NmwtZ, tkj vb tgvktb Ges gvBtμv l tgf Pj vq| Giv ev`Pit`i tLj bvq, K`vtg ivq, wgm vBtj, i tK tU| c tKU K`vj K tU vi, KivúDUvi Pwvj Z K`vk ti wRóti, Gqvi K`zvi, gvBtμv l tgf P`z, cwi ewi K wPEw`b DcKi Ymgr` thgb wfwWl wW` e`e`v, wfwWl

փ Ae GWKkb

tMgm ևւրf, ւրւմAvi, ւրւմուc, tUij tdlv tmU BZ ււ hտճj cՕZ`Kււյi ւbqՏY tKտ` ւ_ւթK GK ev GKւաK ՕգւBտմւcՕմմi ւPcՕ| GB gvBտմւcտմմi ւPc ւտգ ՚Zւi tQvU tQvU cւiտմb`յj KւււDււiտK gvBտմւv KւււDււi etj | Giv ւK? Giv mgւՏZ մմւKՅ| tQvU GK ւPj tZ ւմւյ Kb hv ւեԱւbտ`i MտելYւմvi t_տK AտbK ւKQտKB փb փb Rտետbi e`enւhՕ cւիտեթk ւbտգ GտմտQ| tQvU GB ւPc hv GKւv ev`Pւi AvOտj i bտLi tտթl tQvU, ւեԱւbտ`i AտbK eo eo AvւեՕտii gZB AտbK ւKQտB cւիeZՅ KտիտQ| Giv ւեMZ ւտտbi AտbK մտթqY ւdKkbտK ev`եe iթc ւտտգտQ|

ՕգւBտմւcՕմմi ւPcտKՕ AտbտKB տմKտյj i Mւoxi PւKv ev AտՏ փ BւԱտbi (Steam Engine) mgZտ` etj գտb Kտիb| KւiY AտՏ փ BւԱb GK mgq mgւրտK thfvտe cւիZՅ KտիւQj, AտbտKi avi Yv ՕգւBտմւcՕմմi ւPcՕ տմ iKg Avi GKււ միցւմRK ւեեe NUտZ մթղg| e`Z Avգտ`i AvրտKi RMZտK KւււDււi փւիափտe cՓւեZ Kտի PտյտQ| AZGe, G ւրւb lււ ւK, Gււ ւK KւR Kտի Ges Rտեհւի`vi գւb Dbտթb GտK Avգiv ւK KւրR e`enւi KտիZ cւի Zv AZ`տՏ, iաZjմնKտի Dcյւä KտիZ նտել

gvBտմւcՕմմi

gvBտմւcՕմմi GKււ AvBւմ ev BււտմՕւււ մմւKՅ| Gււ gvBտմւvKւււDււiտii ւմւcBD ev tK`տգ cՕւգւKիY Ask| GKււ նւրvi նւրvi ղճտZղճտ GKտFZ Bտյ KււbK eZՅտK gvBտմւcՕմմi ev ղճտՕւգւKւiK ejv nq| GKււ tcՕMտցi ev`եղb GB gvBտմւcՕմմտii Af`տՏi մսMււZ nq| GKււ gvBտմւcՕմմտii Af`տՏi ւթK GKււ ւմւcBD Ges ւմւcBDi Af`տՏi ւթK MYbv ւեfvM (A L U), Gւc տիւR÷vi (Appropriate Register) Ges KտUտյ մմւKՅ| eZՅտb LSI (Large Scale Integration) tUKտbvյ ւRi et`տյ tZ gvBտմւcՕմմiտK GK ev GKւաK AvBւմi գտ` cտյ tտյv մեե նտթտQ| gvBտմւcՕմմi t_տKB gvBտմւv-KւււDււi K_ւււi DրcւE| tKւb GKււ tcՕMտցi ev`եղտbի մտ՛ th mg`l c`տթc ւեRւոZ տմ, տյv նտյv GK տիւR÷vi t_տK evBւմi Z` Aci տիւR÷տի tcՕY Kտի Ges Z` տյտK ւbտգ MYbvյj-K l հյճյj-K KւR մաւ`b Kտի|

ւմւcBDi Af`տՏi AտbK տյv տիւR÷vi ւթK| G տիւR÷vi տյտK tւււv մԱտյi KւրR Ges KւււDււiտK ւbտ` R t` l qւi KւրR e`enւi Kiv nq| KւււDււiտi ւմւե ւbKտիK Rb` evBււix c×ււZ e`enւi Kiv nq| G c×ււZտZ մետթտq eo iււk 1 Ges մետթտq tQvU iււk 0| `kւցK c×ււZտZ thgb 0 t_տK 9 chտՏ 10ււ iււk ւթK GտZ tZցւb 2ււ iււk ւթK| Avգiv th c×ււZտZ մսL`ւ ւյււ տմււ `kւցK c×ււZ, `տի ւրւEտZ iւPZ| Avգiv `kւցK c×ււZտZ Af`տ` նտգ cտուQ etj B evBււմi c×ււZտK GLb AտՏ գտb նտ`Q| Avգiv hLb KւււDււiտK tKւb Aթյi, մսL`ւ, ւթտյi գւա`տգ tKւb Z` տ` B Zւi մեB տմ MտY Kտի 0 Avi 1 A_տ` նւ (YES) Avi bv (NO) ւտգ Mու մսL`ւi fvտյq| ZւB G c×ււZi bvg evBււix c×ււZ| KւււDււiտii tթտտ evBււix bvտvi e`enւi Kivi մետթտq eo մյեav, Gււ ւdւRK`յj ւիտՕRտUk b հտճj մւնտ` cՕււk մեե| ՕՕevBււixտՕ GKււ j`ւււb kա hւi A_ ՕՕ`տՕ| evBււix ւմււRտK մտթտc etj ՕւեւՕ| GKտտ KտգKււ evBււix մսL`ւթK evBււix tKււ etj| cՕZււ Aթտii GKււ Kտի evBււix tKււ ւbտ` Kiv AvտQ| thgb 011000101- GB evBււix մսL`ւ հյյււ A`ւմK tKււ Abյնտի BտիւR ՕՕGՕ նի dտK ւbտ` R Kտի| KւււDււiտii Kտգ ՕՕGՕ նտյv KZK տյv 0 l 1 Gi mgւո| մBP ււcտյ thgb

Avřjv Rjv Ges bv-Rjv Qrov Avi ZZxq uKQymřebv tbB uVK tZgub UřbıR÷vři i třřřř I
me`jř cřvř nI qv Ges bv nI qv eřř` ZZxq tKıv e`e`v tbB| GB evBbvıx cřıZ Avıe`vi
KřııQřj b eıj břřg GK BřřıR MıYZÁ Ges ZviB j uRřKi Dci uřıE Křı Mřo Dřvřo
thvM, meřqm, ı Y I řvM|

GB evBbvıx msL`vi (1 Ges 0) th tKıv GKıu msL`řřK (1 ev 0) uEU eřj | BIT kãıu
GřmřQ Binary Digit kã hMj t_řřK| gıBřřıvKıřıúDUvi Pıjřřbv nq GK_`Q meřui
gıvřřg| GK_`Q uEU u`řřg `Zıı nq I qıWř` uEU_řř`Qi mgřřř MıVZ I qıWř`řřj v uıřřbře
gıBřřıvçřřmřřı uıřřbřeı Kg nq| gıBřřıvKıřıúDUvi mıvıvYZ th me kã ev I qıWř`e`enıv
Kıv nq řm me I qıWř` mıvıvY mıBR nř`Q 4, 8, 12, 16 ev 32 meřui | AřřK
KıřıúDUvi Aveı uıřřbřeKıřıRı Rb` uıřřbřeımsL`K meřui kã e`eüZ nq| Avı uEU GK
evBU Ges GB Avı meřui evBU řvıv Ařřı, msL`v I Ab`ıv` cřřıvRbıx uPıy uıv`ř Kıv nq|
th tKıv GKıu eY`uPıy thgb`ııo, Kgv BZ`ıı` GK evBU RıvMıv`Lj Křı|

KıřıúDUvi i gřa` meřkl evZřıuıbgq, evZřımAq BZ`ıı`i Rb` th řıvıv e`eüZ nq, Zıv
`Zıı nq msL`v u`řřg| gıvřřıı cřřıj Z řıvıv GK-GKıu kã thgb`Zıı nq uıřřbřeAřřı
u`řřg, msL`vi řıvıv tZgub GK GKıu kã MıVZ nq uıřřbřeıuıRU u`řřg| evBbvıx cřıZřř
ııııRU gıv`řřı; KřřıKıu uEU uıřřg GK GKıu kã `Zıı nq| KıřıúDUvi i KıřıRı mgq GB
kã GKK uııvıře e`eüZ nq| mg`ııı křãı AvıKıřı mıv`Z_řřK Ges `ıvıřřıı Z nq|
kã u`řřg tKej th msL`řřK cřřıv Kıv nq, Zıv bq, Zıv gřa` uıııRřıı uıřřbřeııvıv
Abıvıx uıřřbřeAřřı, meřkl meřkl uPıy BZ`ıı`řřKı cřřıv Kıv hvq| GK GKıu křã meřui
msL`v 1 t_řřK 100 çřřı nřřZ çřřı| AřřK KıřıúDUvi 8 meřui kã e`enıv Kıv nq-
mıvıvYZ GřK eıj v nq evBU (Byte)| GB 8 meřui evBbvıx msřKZ řvıv meřıvıu 256ıu
Ařřı ev K`řřı KUi řřLıv nq| Zıv Qıvıv 12, 16, ev 32 meřui křãı I hř_ó cřřı b AvřQ|

řřııřřı řıvıv (Programming Language)

řıvıv nřřıv thvMřřıřřıı gıv`g| gıvıy řıvıvı gıv`řřg çı`řřıı gřa` řıřeı Av`ıv çııv
Křı| KıřıúDUvi GKıu řřıkb| Zıv uıR`^řřıv řıvıv bıv| řm BřřııR, eijsjv, Avııe, D`ř
BZ`ıı` tKıv řıvıv eřř bıv| `ıay řřıkbı řıvıv řřııřřıı uı Lřřı B řm eřřřZ çřřı|
řřııřřı G řıvıv_řřıřřK uıZb řřıı řıvıv Kıv nq| h_ıv-

- uıgře`řřıı řıvıv (Low Level Language)
- gıv`řřıı řıvıv (Mid Level Language)
- D`P`řřıı řıvıv (High Level Language)

uıgře`řřıı řıvıv

G řıvıv KıřıúDUvi řřıkbı uıR`^řıvıv| G řıvıv evBbvıv msL`v Ges msřKZ e`eüZ nq|
řřıkbı řıvıv uııLZ řřııřřııK object řřııřřıı eıj v nq|

- řřıkbı řıvıv (Machine Language)
- A`řřııřřıı řıvıv (Assembly Language)

ᶿ Ae GWᶿKkb

tguktbi fvlv: 0 Ges 1 w`tq evBbwi c×vZtZ th fvlv tj Lv nq tmiUB tguktbi fvlv| G fvlvq tcᶰMᶰg tj Lv AZ`šl KwMb Ges mgq mvtcᶰᶰ e`vci | G fvlvq tj Lvi Rb` KivúDUvtii cᶰZiU wbt`R I ᶿZ`vtbi cᶰKZ.Ae`vi aviYv _vKtZ nq| G fvlvq GK aiᶰbi tguktbi Rb` wj uLZ tcᶰMᶰg Ab` aiᶰbi tguktbi e`envi Kiv hvq bv| G fvlvq tcᶰMᶰg wj LtZ ntj KivúDUvi nvlWᶰq`vtii I ci fvj Ávb _vKtZ nq| cᶰKŠkij K KivR G fvlvi e`envi AZ`vek`K|

A`vtmᶰg fvlv: G fvlv wvfbᶰmstKZ mnᶰthvM MvWZ| G Rb` GtK mvtKivZK fvlvi ejv nq| G fvlvi tᶰᶰᶰ wbt`R I Zt`i wKivb evBbvi ev tl vok msL`vi mrvvth` bv w`tq mstKtZi mrvvth` t`qv nq| G mstKtZK ejv nq mvtKivZK ev tbtgmbK tKivW| thgb mÁqtK ivL Gi tbtgmbK LDA| G fvlvi tᶰᶰᶰ I KivúDUvtii Af`šlixY msMVᶰbi Dci aviYv `i Kvi |

ga`ᶰᶰi fvlv

ga`ᶰᶰi fvlvq KivúDUvtii wU chᶰᶰqi tcᶰMᶰgs Gi gra`tg nvlWᶰq`vi wqšY I wntᶰg tcᶰMᶰg iPbv Kiv hvq| G fvlvq D`P`ᶰᶰi fvlvi mᶰᶰta cvlqv hvq Avevi wbgᶰᶰi fvlvi mgKᶰᶰ tcᶰMᶰg iPbv Kiv hvq| w (C) Ges tdv`ᶰ(Forth) G `ᶰᶰi fvlv|

C

C: Avtᶰwi Kvi tej j`vetiUwi tWvbm wvP 1970 mvtj G fvlvi D`ᶰᶰeb Ktib| wntᶰg tcᶰMᶰgs Gi tᶰᶰᶰ G fvlv e`eüZ nq| c`v`vtj i gtZv C GKiv AvajbK Rbucᶰᶰ fvlv| G fvlvq tcᶰMᶰg msvᶰᶰB nq Ges mnᶰR mstkvab Kiv hvq| DcvÉ mÁvj tbi eYᶰvi Rb` G fvlvi mᶰᶰav AᶰbK teik etj fvlvU Ab`vb` fvlvi tPtq AᶰbK teik Rbucᶰᶰ nt`Q Ges eZᶰᶰtbl G fvlvi Dbᶰᶰb KivR Pj tQ| C fvlvi mᶰᶰúúZK Kvtj i Dcfvlv ntj TURBO C ++, G fvlvq tcᶰMᶰᶰgi MvZ Ab`vb` fvlvi Zᶰᶰbvq `ᶰZZi Ges GtZ AᶰbK jvBteix diskb itqtQ| KᶰᶰúBjvi tcᶰMᶰg iPbvi Rb` meᶰPtq teik fvlv wntᶰᶰe C e`eüZ nq| G fvlvq I qvW`vi, tj vUv, wvteR BZ`v` Rbucᶰᶰ c`vtKR iPbv Kiv ntqtQ|

D`P`ᶰᶰi fvlv

KivúDUvtii th fvlvq meRbᶰeva` evK`, eYᶰᶰ msL`v e`envi Kti tcᶰMᶰg iPbv Kiv hvq ZvᶰK D`P`ᶰᶰi fvlv etj | D`P`ᶰᶰi fvlvq tcᶰMᶰgs Gi tᶰᶰᶰ wbtgᶰᶰ mᶰᶰav, tjv cvlqv hvq:

- G fvlvq wj uLZ tcᶰMᶰᶰg th tKiv KivúDUvtii e`envi Kiv hvq|
- G fvlv mnR etj mᶰᶰavtYi e`envi DcᶰᶰvMx|
- D`P`ᶰᶰi fvlvq ZvovZvvo tcᶰMᶰg iPbv Kiv hvq|
- wbgᶰᶰi fvlvi Pvi cᶰᶰvU wbt`ᶰki RvqMvq D`P`ᶰᶰi fvlvq gvᶰᶰ GKiv evK` wj Ltj B Ptj |
- G fvlv e`envi Rb` nvlWᶰq`vi Gi Dci fvj `Lj _vKvi cᶰᶰqvRb tbB|

500mUi gŷZv D`P`ŷii fvlv AvtQ| Gi gta` cÅvb fvlv nj: BASIC, PASCAL, FORTRAN, COBOL, PROLOG, ALGOL, APL, LOGO, ADA, SNOBOOL, PL/1, LISP, PILOST BZ`w` |

BASIC: GiU KŷúDUvŷii GKŷ mnR fvlv| Kŷ_vck_ŷbi Rb` G fvlvi e`envi tevk| GKrb KŷúDUvi fvlv ŷkŷv_ŷ Rb` cŷg fvlv ntjv BASIC| weÁvb, e`emv emYR`, Avdm Ges Mŷni Kvhw` ŷZ G fvlvi e`envi nq|

PASCAL: weL`vZ weÁvbx PASCAL Gi bvgvbyvŷi G fvlvi bvgKiY Kiv ntj| c`v`vŷ fvlvUi D`m`eK bb| fvlvU ŷbgŷ KŷiŷQb mBRvij`vŷDi cŷdmi ŷbŷKvjvm DBi_ (Nicolous Wirth) 1968 mŷj| c`v`vŷ weÁvbK I emYvR`K Dfq KvŷRiB Dchŷ| Avevi e`vP I cvi`úvi K mŷhvM c`wZŷZi Gi e`envi AvtQ|

FORTRAN: tdviUŷbB KŷúDUvŷii cŷg D`P`ŷii fvlv| 1957 mŷj IBM tKv`úvbx weŷklÁiv G fvlvi cŷZŷ Kŷib| FORMULA TRANSLATOR Gi mŷvŷB iŷc ntjv FORTRAN| weÁvbK cŷKŷkij K KvŷR G fvlvi e`envi tevk|

COBOL: Common Business Oriented Language Gi mŷvŷB iŷc nj COBOL| 1958 mŷj Avŷgwi Kv hŷivŷóŷ cŷZiŷv wefvŷmi mŷvŷq mŷhvMvZvq G fvlvi D`m`e nq| GiU emYvR`K cŷqŷmi GKŷ mveRbxb fvlv|

PROLOG: KŷúDUvi cŷwZi Mŷel Yvq G fvlv e`eüz nq|

ALGOL: Algorithmic Language Gi t_ŷK ALGOL kÁmUi Drcw`E| 1958 mŷj BDŷivŷc G fvlvi D`m`e nq| A`vj Mj weÁvbK KvŷR e`eüz nq|

APL: AvBweGg-Gi tKŷb_ AvBfvi mb G fvlvi D`m`eK| A Programming Language Gi mŷvŷB iŷc ntjv APL| G fvlv cŷkw`Ei i`wZi Rb` e`eüz nq| G fvlvq e`envi Kvix Zvi `Zvi ŷbŷ`R e`envi KiŷZ cvŷi| APL G mŷR I mŷvŷŷc RŷUj tcŷMŷg tj Lv hvq Ges UvBg tkqvŷis e`envi Kiv hvq|

LOGO: GiU tQvUŷ`i DcŷhvMx GKŷ mnR fvlv| wPŷvsKŷbi Rb` e`eüz G fvlvi cŷkw`Ei i`wZ e`envi Kŷi KŷúDUvŷii mŷ_ mŷhvM iŷv Kiv hvq|

ADA: Avŷgwi Kv hŷivŷóŷ cŷZiŷv wefvM G fvlvi RbK| 1980 mŷj i RjvB gvŷm G fvlvi D`m`e NŷU| AvawbK KŷúDUvŷii aviYvi Avne`vi K Pjŷ ŷ e`vŷŷRi eüzKwe evqŷŷi tgŷq A`wWv AvMv`vi bvgvbyvŷi G tcŷMŷgi bvg ivLv A`wWv| A`wWv GKŷ epr fvlv| Gi Rb` epr `ŷZweŷkó KŷúDUvi `iKvi nq|

SNOBOOL: dtUv UvBc tmUŷŷq G fvlv e`eüz nq| G fvlv tKvb tj Lvq tKvb kÁ KZevi AvtQ Zv tei Kivi tcŷMŷg iPbvi DcŷhvMx|

ḏ Ae GWžKkb

PL/1: GuU tdviUib fvlvi GKuU ewaZ i/c| 1966 mrtj Bsj v̄tD cġg PL/1 fvlvi DTMe| eÁmbK I ewYwR^K Z_ cġquvKiY Qiorl G fvlv cKZ.mgq (Real Time) cġquvKiYi DchY| GuU epr fvlv|

LISP: msL v̄ tġ KVR bv Kti G fvlv h̄yB v̄ tġ KVR Kti |

PILOST: GKuU uekI cġquvMi fvlv| KivúDUv̄ti miv̄vth̄ w̄kġv I cġkġv̄Yi Rb G fvlv e eüZ nq|



civ̄v̄Ei gj v̄qb: 6.4

A) iPbv̄gj-K cġæ

1. gvBt̄m̄vcġmmi I gvBt̄m̄vKiv̄úDUv̄ti gtā cv_Ŕ w̄k?
2. gvBt̄m̄vcġmmi w̄k? w̄m̄icBD w̄v̄m̄t̄e gvBt̄m̄vcġmmi ub̄tġ Av̄tj v̄Pbv̄ Kiab|
3. t̄K v̄ tġ cġquvKiY Ask w̄k? GB Ask v̄ tġ w̄k w̄k KVR Kiv nq?
4. w̄P̄t̄i miv̄vth̄ Kiv̄úDUv̄ti msMv̄b Av̄tj v̄Pbv̄ Kiab|
5. weU, evBU I Kiv̄úDUvi ej t̄Z w̄k tev̄Sb?
6. gvby I Kiv̄úDUv̄ti gtā miv̄ k Av̄tj v̄Pbv̄ Kiab|
7. Kiv̄úDUvi t̄cġM̄t̄gi fvlv w̄k? fvlvi newf̄b̄e li t̄j v Av̄tj v̄Pbv̄ Kiab|
8. w̄m̄icBD w̄k? w̄m̄icBD-Gi newf̄b̄eAsk eYB̄v̄ Kiab|
9. nvW̄P̄q̄vi Ges mdUl q̄vi ej t̄Z w̄k tev̄Sb? nvW̄P̄q̄vi I mdUl q̄v̄ti gtā cv_Ŕ w̄k?

cW 6.5

m`vtUj vBU

Dt`ik`

GB cW tk`l Avcib—

- m`vtUj vBU wK Zv ej tZ cvi`teb;
- m`vtUj vBUi mweR thvMvthvM e`e`v e`vL`v Ki tZ cvi`teb;
- m`vtUj vBU e`envti i t`q`l mgn wPyZ Ki tZ cvi`teb Ges
- cBt`fU m`vtUj vBUi thvMvthvM e`e`v l Kvh`eg eY`v Ki tZ cvi`teb|

m`vtUj vBU ch`y`g gvbe mf`Zvi BwZvntm GK hMv`Skvix wece| G h`M m`vtUj vBU wmt`÷tgi Abxw`wZi K_v wP`S`B Kiv hvq bv| Gi Afv`te APj ntq cote tUuj thvMvthvM Ari Bluvi`tbU e`e`v, G ch`y`g ZvB Avgt`i Rxe`tbi mvt`_ l Ztc`Z Fv`te Rwo`tq AvtQ|

m`vtUj vBU KvgDwb`tkkb ntj v DcM`h w`bq`w`sz thvMvthvM e`e`v| G ait`bi DcM`ni gZB Avi l Kw`g DcM`h gvby` Zwi Ki tQ Ges Zv evq`g`D`j cvVt`Q A`bKw`b at`iB| c`w`ex th MvZ`te`M w`b`Ri A`q`i Pricv`k Njycv`k Lv`Q tmB GKB MvZ`te`M GB KvgDwb`tkkb m`vtUj vBU, t`j v l N`ji hv`v`Q c`w`exi P`ri w`t`K| t`e`k`i f`v`M KvgDwb`tkkb m`vtUj vBU `v`cb Kiv nq e`F`v`Kvi K`q`ct`_ c`w`ex t`_t`K tgvUvg`w` 36,000 w`Kvg Dct`i| Ari GB KvgDwb`tkkb m`vtUj vBU, t`j vB cvt`e` w`t`q`Q c`w`exi thvMvthvM e`e`v|

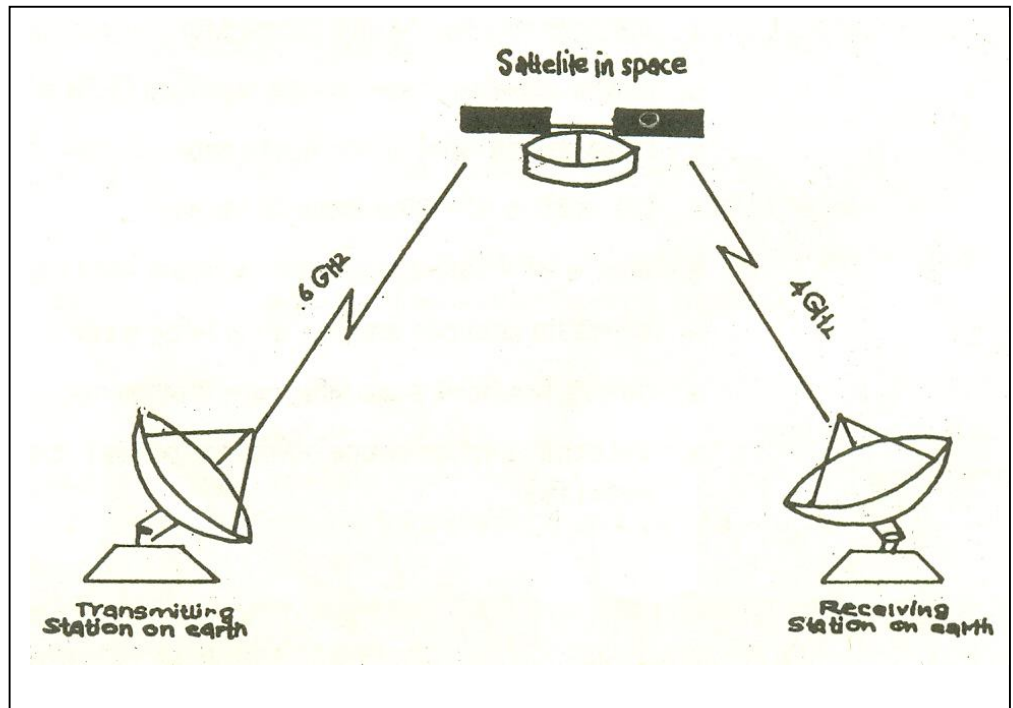

wP`T 6-5.1: Z`_` tc`Y l M`h`Y|

Gt`i KvR j vMtgB Avtgi Kvi tej j`vefi Uvi i ZrKvj xb AwaKZ® Rb cvqvm©1962
mvtj AvKvfk QvotZ m¶g nb c¶g KvgDvbtKkb m`vtUj vBU tUj ÷vi | tUj ÷vi bvtg
cvi¶PZ GB DcMhB c¶g, hvi gva`tg AZj vstKi `gr tKi `tjv t`tki gta` kã, Qve I
Z_` Av`vb-c¶vb m`e n¶q¶Qj | GB tUj ÷vti ARm`e`yZK hšysk ¶Qj, c¶ZUv tKvb bv
tKvb vektl KvRi Rb` ¶PvYZ | ¶KQyhšysk ti¶¶I mstKZ `Zvi Ki¶Qj, hvz c¶_exi
gv¶tZ j vMvbtv A`vUbv, tj v tUj ÷vti Ae`vb vba¶¶Y Ki tZ cvi | ¶KQyhšysk DcMhni
Kvh¶vj x vqšy Ki¶Qj | Zte te¶kivM hšysk B c¶_exi m½ thvMvthvM i ¶vi KvR
Ki¶Qj | hLbB tUj ÷vi tKvb mstKZ cv¶Qj c¶_ex t`tK, DcMh Aev`Z ¶U¶Yc¶vi ¶
bvtgi hšy tmB mstKZ tK c¶q 10 tKv¶U, Y Kti Avevi tmB mstKZ c¶_exi Ab` c¶šl
cvi¶tg v`v¶Qj | Avtgi Kv, Bs j`v¶ I d¶¶Y ivLv ARm`A`vUbv, hvK Av`÷kb l ej v
nq, tUj ÷vti gva`tg Z_` Av`vb-c¶vb Ki¶Qj | GB cvj vqšy e`e`vi m¶¶K`¶¶Qj
A`vDvfi |

1965 mvtj i Gvc¶j ¶Avj`evW® bvtg GKv DcMh Dr¶¶cY Kiv nq | Gi gva`tg
tRvbfvi ¶¶KrmKiv mivmvi Avtgi Kvi gvBtKj tWv¶Ki Kiv ¶r¶ct¶i A¶`yc¶vi t`L tZ
tc¶j b | Gi gva`tg Avtgi Kv l BDtvtci gta` tUj thvMvthvM `vncZ nj |

Avj ¶vW® Dr¶¶c¶Yi ci GtKi ci GK Gi Kg thvMvthvM i ¶vKvix DcMh mvd¶j`i m½
civbtv n¶q¶Q | GLvbKvi DcMh, tj v Avj ¶vW® t¶¶q c¶q 500, Y tekx Z_` Av`vb
c¶vb m¶g | 1974 mvtj Dr¶¶B l ¶q ÷vi DcMh¶U c¶g fmgj qK¶¶` DcMh, hvK
KivKv¶¶ Rv¶¶vi gta` thvMvthvM j vMvbtv n¶q¶Q |

eZgv Ae`v

AvM Kv¶g DcMhni m½ Z_` l mstKZ Av`vb c¶vb nZ ¶Avbvj M¶ mstKtZi gva`tg |
GtZ gj- mgm`v ¶Qj c¶qvRbxq Zt`i m½ Ac¶qvRbxq mstKZ (btqR) vgtk thZ |
AšZ¶Uv l qvi, vj tKvbUv c¶qvRbxq, Zv etS DVtZ cvi Z bv | vMvRv¶j mstKZ cvvbtv
d¶j AvR G mgm`v l `t n¶q¶Q |

GLb AvšR¶ZK tUj tdvb thvMvthvMi c¶q vZb-PZZ¶sk Kiv nq fmgj qK¶¶` DcMhni
gva`tg | i ay tUj thvMvthvMB ev Kx Kti evj, ej tZ nq- G K_v wekpe`vcx ¶Uv¶ tBU l qvK,
d`v- me¶¶¶tB mZ` | G Qvov mvgvi K ¶¶¶ AvRKvj DcMhni gva`tg `vqx t÷kb l
Qyšl Rvnr ev Dtov Rvnr¶Ri gta` l thvMvthvM ivLv nq | GKv DcMh t`tK hv` n mS`K
fçp` t÷kb t`Lv hvq Zte GKB m½ tm DcMh n(n-1)2 fvt¶ f-c¶¶i t÷kb, tj v¶K
h¶ Ki tZ cvi |

cKvif`

GLb Aek` Avi l tek KtqK aitbi m`vtUj vBU vmt÷tgi Avvef¶e Nv¶ ¶Rl vmt÷tgi
e`envi tek Ktg t¶¶Q | thgb m¶v¶Y tgvevBj tUj tdvb Avi tmj¶vi tdvbtK Pj v¶Z
¶RGMGg (tMve j vmt÷g di tgvevBj) m`vtUj vBU e`eüZ n¶¶Q | Ab`v tK m`vtUj vBU
tdvb, tj v Pj ¶Q vj l (tj v-Av`Ave¶) m`vtUj vB¶Ui m¶vqZvq |

c¶vb KvR

m`vtUj vBU thvMvthvMi gva`tg c¶_exi tKv`v l tKD GLb Avi vev¶Qv¶bq | mevB GKv
GKK ¶tMve j v¶tj ¶Ri ¶ evm¶`vq cvi YZ n¶q¶Q | hv` l GB c¶h¶¶ i Drcv¶ l vev¶k
D¶¶k` ¶Qj v¶bt`tk t¶¶qv`vMvix l bRi`vix Kiv, ¶Kš` eZgv Kvh¶ej xi m½ Gi
e`eavb v`li | eZgv vekt; m`vtUj vBU c¶h¶¶ c¶vb th `¶ KvR e`envi n¶¶Q Zv nj :

Dëvtj B GB mg`l tKv`úvxi weÁvcb tPv`L cto| 1995 mvtj Avtgi Kv tdWitj Kgyb`Kkb cu`ex`v`cx tgevbj KvgDvb`Kkb (tmj`jvi tdvb Ges tcRvi) LtZ temiKvix webtqM`K Abtgv`b t`q| dtj Zviv tjv-Av`©Aime`U DcMh emtq`bR`^ KvgDvb`Kkb Mto tZvtj | GB DcMh`wbq`S`Z thvM`thvM e`e`v`K `Bfv`M fvM Kiv nq`weM`ij I Ges`ij U`ij I m`t`÷`g|

weM`ij I m`t`÷`g: G cxwZ`Z GKwU ev`úU eo m`vtUj vB`Ui RvqMvq e`envi Kiv nq KtqKwU tQvU tQvU m`vtUj vBU| GtZ e`eüZ nq tgvU 48wU m`vtUj vBU Ges G`ij cu`ex c`oi 1414 wKvg Dcti Qúv Ztj Ae`vb Kti| GK GKwU Ztj `v`K 8wU Kti m`vtUj vBU| m`vtUj vBU`tjv KvR Kti wicUvi wntmte| GKUv m`vtUj vBU t`K Avti KUvq av`v tL`Z tL`Z wv`e` wKvbvq t`c`úQ hvq t`c`úZ l`qf| tM`e`÷`ti cvlqv hvq l`q`vi`tm, tcwRs Ges tmj`jvi tdvbi m`thvM mgeav|

dvBeri AcwUK chny` hLb chvi jvf KiwQj tm mgq t`KKB `ieZ`P`thvM`thvM gva`g wntmte GKB mgq l`q`vi`tm| weKv`k jvf KitZ `v`K| Awki `kK t`KKB m`vtUj vBU chny`i `Z`S; wKQy`enkó` d`U D`V, Zvj M`DD t`÷`k`b e`qeüj bq Ges c`P`z tjvKetj`il c`úqvRb nq bv| tKej (Cable) tbU`l`qv`K`P`gZ c`v`v`ox A`Á`j wKsev gi`af`ig`Z KóKi KgZrci Zv Pjv`v`Z nq bv, G mKj `M`Z A`Á`j tKej (Cable) `v`cb ev P`i i tKv`b m`thvM `v`K bv KvY m`vtUj vBU thvM`thvM Gqvti i gva`ig Kiv nq| hM hM a`ti e`v`cK Dbq`b`i avivq m`vtUj vBU thvM`thvM GKwU Kv`h`R`i Ges wek`l`gva`g wntmte Mto D`v`úQ, cvwb ev gi`af`ig wKsev Ab`f`v`te we`f`b`w`R`b`M`v`xi Rb` GB gva`g c`k`w`Z`x`f`v`te D`E`g|



cv`V`E`i gj`v`qb: 6.5

A) i P`b`ig`j`K c`k`e

1. m`vtUj vBU wK? Av`_`q`÷`kb wK?
2. m`vtUj vB`Ui m`v`v`th` thvM`thvM e`e`v` wK`f`v`te Mto D`v`úQ Zv e`Y`v` Ki`ab|
3. m`vtUj vBU thvM`thvM e`e`v`i` q`w`Z`Ki w`K` wK` wK`?
4. Dcv`E` m`st`h`v`M e`e`v`q` f`-DcM`h`ni` i`æ`Z`j`Av`tj`v`P`bv` Ki`ab|

cW 6.6

tbUI qvK®

DჭiK

GB cW tkქI Avcb—

- tbUI qvK®K Zv e`vL`v KiჭZ cviჭeb Ges *მეწარმეები* tbUI qvK® bvg ejჭZ cviჭeb;
- tbUI qvK®ენი i tქქ, tქv e`vL`v KiჭZ cviჭeb;
- KიუDUvi tbUI qvK®e`vL`v KiჭZ cviჭeb Ges
- tbUI qvK® Rb` e`e`Z msthvMKvi x Dcv`vტი bvg ejჭZ cviჭeb Ges Dcv`vb, tქvi cv`R` e`vL`v KiჭZ cviჭeb/

tbUI qvK®kაიუ KიუDUvi RMჭZ AvRKij მეჭტq AvtქmPZ/ Avcb hLb Avcbvi e`Uჭ მიჭ_ tUij tდvტი K_v ej tQb ZLb გიუ nჭ`Q tUij tდvტი tbUI qvK® Avcbvi KიუDUvi ი`ტq ხი` Avcb Avcbvi e`Uჭ KიუDUვი i მიჭ_ thvMჭhM Kტიb Zტე გიუ nტე KიუDUvi tbUI qvK® მრავი Yფიტე KიუDUvi tbUI qvK®tქv `B ev ZტZმაK KიუDUvi Gi gტა` thvMჭhM/ gტბ Kiab, Avcb Ges Avcbvi Avi `kRb cჭZტეკx cჭZტKB Zv`i ემოტZ KიუDUvi e`ენი Kტიb/ GLb ხი` GB KიუDUvi, tქvტK Zvi (Wire) ი`ტq Ggbfიტე Rტო t`I qv hვq hტZ Kტი GK KიუDUvi t`ტK Ab` KიუDUვი Z` Av`vb cღvb Kiv m`e nq Zvntქ B `Zვი nტე GKიუ tbUI qvK®Avi GB aiტი tbUI qvK®ტK ejv nq Local Area Network ev LAN/ LAN მრავი YZ Aí RvqMტZB mქgve`_vტK/ tKv-გი qvj tქეჯ ev UBტóW tcvitქ msthvMKvi x Zvi ინტმტე e`ენი Kiv nq/ j`vb KivW`AmZვი³ nვWჭq`vi ინტმტე cჭZიუ იცმტZ (Personal Computer) hჭ Kiv nq/

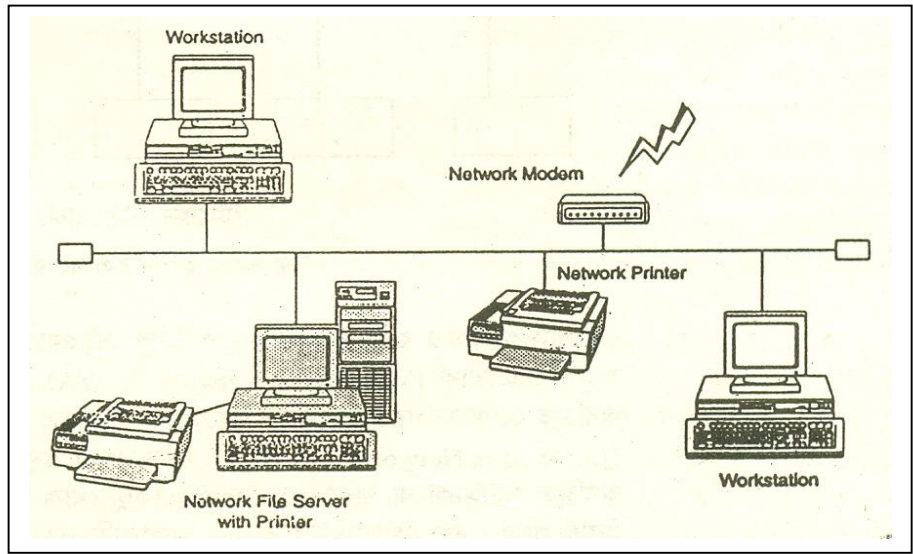

იPტ 6-6.1: tbUI qvK®WvqvMტg/

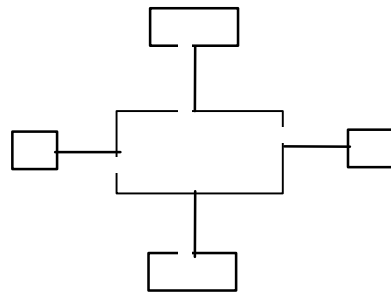

÷vi tbUI qvK

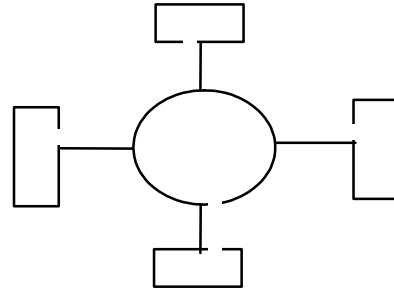

wi s tbUI qvK

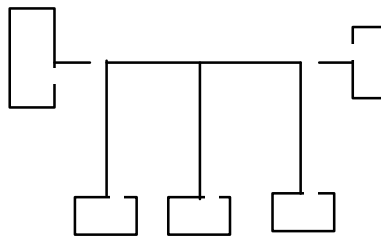

evm

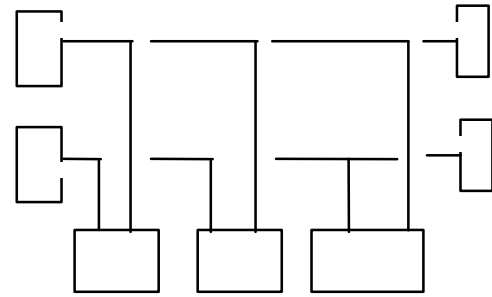

gwië evm tbUI qvK

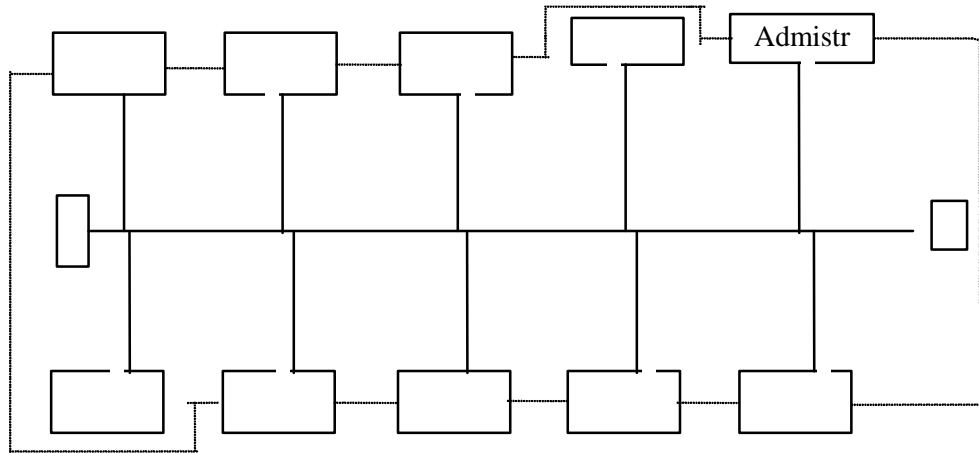

tUvKb tbUI qvK

uPÎ 6-6.1: newfbæcKviti i tbUI qvK®

tfŠtMvj K mŋvri e`vB Abŋvqx KvıúDvri tbUI qvK® newfbæbvg t`qv nŋtqQ| we`Z. AÂj tbUI qvK®(Wide Area Network ev WAN) `k t_ŋk kZ vKtj vŋUvri `iZj Aew`Z thvMŋthvMi hšj tjtZ msthvM w`tZ cvti| Aciv`ŋk mŋvZ AÂj tbUI qvK® (Local Area Network ev LAN) ev j`vb msÁv Abŋvqx 2-5 vKtj vŋUvri we`iZ.i gta` Aew`Z AÆvj Kv ev Nubôfvte Aew`Z vKQvrsL`K AÆvj Kvi gta` thvMŋthvMi mŋvav w`tZ cvti| `k vKtj vŋUvri ev Gi KvQvKvQ `iZj gta` Aew`Z newfbæAÆvj Kvq

ᄡ Ae GW#Kkb

thvM#thv#Mi Rb" th tbUI qvK©Zwi nq ZvtK ejv nq tqtU#ciw Uvb Gwi qv tbUI qvK© (MAN) | mwgZ, weZ. I tqtU#ciw Ub AÅj tbUI qvK©tj v#KI tMBUI tq (ᄡ wfbce tbUI qvtK# gta" BvUv#dBm) I we#Ri (ᄡ GKB iKg j vb-Gi gta" BvUv#dBm) gva"tg msh# Kti GKw vekj tbUI qvK©Zwi ntj ZvtK ejv nq tMvej tbUI qvK#

ᄡ ev ZtZvnaK K#úDUvi Ges K#úDUvi Rivxq hšc#vZ thgb w#úvi, wv W#BF, c#vi BZ"v GKw m#Z wbgq Abgvqx ci"úi ci"úti m# GKw mvaviY gva"g w"tq thvM#thvM vcb I WvUv t#Y ev M#tYi th e"v ZvtKB ejv nq K#úDUvi thvM#thv#Mi tbUI qvK©(Computer Communication Network) | epr, ¶Z"ev gvBt#v K#úDUvi wKsev e"envi Kvixi Uv#g#j mn mKj Avb#v#K hšv B G ai#bi tbUI qvtK# mvt# msh# ntZ cv#i; c#B m#av, tjvi gta" D#j L#thvM" nt"Q- (1) e"qeúj m#ú#i m# I mgq f#v#v#M Kti e"vK e"envi, (2) wevfbg#x c#qv#Mi m#tebv, (3) Z" ev tWUvi w#v#v#v I w#f#thvM"Zv, (4) i¶Yvte¶Yi m#av Ges K#úDUvi I Avb#v#K hšc#vZi m#Z gvb wba#Y | B#j KU#bK WvUv c#m#ms (Electronic Data Processing ev EDP), ᄡs#v#q Av#dm (Office Automation), B#j KU#bK tgBj (Electronic Mail), w#i c#Z#v#b ᄡs#v#q e"v (Industrial Automaiton), Zvr¶w#K (Real-Time) k# I Q#e t#Ymn tUvj m#v#j b (Teleconferencing) BZ"v eú#ea c#qv#MB K#úDUvi tbUI qvtK# gva"tg m#e |

LAN-Gi Aaxb K#úDUvi, tjvi gta" AšZ GKw K#úDUvi c#jv tbUI qvK©e"v#úK c#v#v#v#v Ges w#qš#Yi v#q#Z; w#tqv#RZ v#K, hv#K K#úDUvi tbUI qv#s-Gi c#v#v#v#v ejv nq Server Av# m#f#-Gi mvt# h# Ab"vb" K#úDUvi, tjv#K ejv nq I qvK©#okb | LAN-Gi "e#k#" ntjv Gi AšM# K#úDUvi Ges Ab"vb" w#v#v#v#v (thgb-w#úvi, Secondary Storage Device, Modem BZ"v) GKw #úw# # m#v#v#v#v#v t#¶T i gta" GKw#i mvt# Aciw m#v#v#v h# v#K | GLv#b w#v#v#v t#¶T w#v#v#v ntZ cv#i GKw K¶ ev GKw c#jv v#v#v wKsev GKw GjvKv |

Avevi aiab, Av#v#v Av#v#v evsjv#tk Av# Av#v#v GK eúZAv#v#v USA-tZ | GLb Av#v#v i e"eúZ K#úDUvi, tjv#K hv" c#Z"¶f#v#v GKw#i mvt# Ab"ú#K Zvi w"tq R#j w"tZ P#B Zvntj Zv m#e n#e bv | Z#e Telecommunication Ges Microwave Satellite Communication #v#v GB ᄡ K#úDUvi Gi gta" c#v#v#v#v#v m#thvM vcb Kiv m#e | Av# GB c#v#v#v#v tbUI qvK©K ejv nq Wide Area Network ev WAN-Gi c#v#v#v#v "e#k#" ntjv th, Gi Av# Zvaxb K#úDUvi, tjv c#v#v#v#v th tK#v v#v#v Q#v#v#v v#K#Z cv#i Ges G# i gta" c#Z"¶ ev m#v#v#v#v tK#v m#thvM v#K bv eis Aci GKw thvM#thvM e"v#K Ae#v# Kti w#tR# i gta" m#thvM v#v#v#v gva"tg Z" w#v#v#v Kti |

tbUI qvK©-Gi gva"tg c#jv c#v#v#v AvR n#v#v#v g#v#v G#b t#jv m#e | Db#z we#k# m#v#v#v Y#v#v#v#v K#úDUvi tbUI qvK©GLb GKw Aciw n#v#v#v#v | w#v#v, e"emv, c#v#v#v, c#Zi¶v, w#v#v#v#v, c#v#v#v#v#v, i#Zc#v#v#v#v, tjv#Z K#úDUvi tbUI qvK©Gi c"v#v#v#v#v v#v#v#v#v thb GKw AK#v#v#v e"v#v#v |

tbUI qvtKʻ gj- Df`k` `z Ges wbfʻthvM` Z` thvMvthvM ntj l, GB tbUI qvK[©] AeKvVtgvZ itqtQ eúnea DcʻthvM| Lʻ tQvU cwi mi t_ʻK wcl quU j ʻʻ Kiv hvK| GKU tQvU Awclm cʻwU KúDUvi AvtQ| wKš` Búvi tbU mjev e`envi i DcʻthvMx KúDUvi AvtQ gvĀ GKU| Gʻʻʻt meivBʻK B-tgBj ev eʻDwRs-Gi Rb` H wv` ʻ KúDUvi wB e`envi KiʻZ nte| GiKg Ae`vq KLtbr` ʻRb e`envi Kvix GKmʻ½ Búvi tbU e`envi KiʻZ cviʻeb br| Zte H Awclmi KúDUvi ,tjv tbUI qvK[©] e`e`vcvri gva`tg ci`úti i mʻ½ hʻ ʻvKtj e`envi Kvix wB wB KúDUvi eʻtmB Búvi tbU mjev e`envi KiʻZ cviʻeb| iayZvB bq th tKvb AvKwZi dvBj GK KúDUvi t_ʻK Ab` KúDUvi ciVtZ cviʻeb| G Qvov tbUI qvK[©] cwi tēk Ab` KúDUvi i vʻʻʻZ GucʻKkb Ges tWU dvBj e`envi mʻe| Avmtj tbUI qvK[©] cwi tēk wvfbwv tvmʻthgb- wclUvi, dvBj, Guc- tKkb tclMg cʻwZ. tkqvi Kti e`envi Kiv hvq| hv mveR wmt`tgi `ʻʻZv eúj vsʻk eʻx Kti |

gʻtb Kiab-

ev`e D`niY

AvR Awclm thʻZ cviʻtj b br wKš` GKU AZ`š` Ri a`x wguUs AvtQ| hv` AwclmU j`v b Gi Ašfʻ nq Avi Avcbri eimvq e`eúZ KúDUvi w hv` H tbUI qvK[©] Gi mvt` msthvM `vcv KiʻZ cviʻi Zvntj Abvqvm eimvq eʻtmB Avcbw wguUsU tmti tdjʻZ cviʻeb| wKsev gʻtb Kiab, Avcbri AwclmU 7g Zjvq A_P cviʻki `vj vʻbi 10g Zjvq GKU , iazcʻy[©] WKzʻU ciVtbr` i Kvi | LAN `vKtj Avcbw i`ayWKzʻU Gi wclU KgvDwU w`tq w`teb, Avi Aci cʻʻ Zv` i wclUvi t_ʻK WKzʻU-Gi wclU AvDU tctq hvte| AʻtbKw b mʻʻʻvrb tbB Avcbri `tj `vKv wclURbU i mvt` | WAN-Gi eʻšjʻZ Zvi gʻy`QwēʻK gēʻZ`btq AvmtZ cviʻeb Avcbri KúDUvi i `tēb; Avjvc Avtj vPbv Pij vʻZ cviʻeb Ggbvte thb wZwb Avcbri mvgʻtb eʻtm AvtQb| KúDUvi tbUI qvK[©] e`envi Kti Avcbw Nti eʻtmB M`vm wj (Electric Bill) Rgv w`tq w`Z cviʻeb| tmti tdjʻZ cviʻeb wvU AstKi e`vsuKs tj bʻ b| wKtb tdjʻZ cviʻeb AvšRwZK tkqvi evRvʻi tKvU UvKvi tkqvi | wbgMantZ cviʻeb Z` ` Avtbi gnmgtj` [Aek` G mg`Imjev GLtbr Avgt` i t`k Pij yq bvB|]

Avgt` i t`k KúDUvi tbUI qvK[©]-Gi e`vck cʻhvi cʻqvrB| wKʻv, cʻkvb, e`vsuKs cʻwZ. tʻʻʻt KúDUvi tbUI qvK[©]-Gi e`envi Gʻtb w`Z cviʻi bZb MvZ|

GKU cʻZvʻbi K_v aiv hvK, hv kvLv mgt` mgMŏt` ke`vcx Qwotq AvtQ| GB Awclmi me kvLvi Z` KúDUvi ivLv ntj tKvb e`e`vcʻKi cʻʻ ZvrʻwKfite GK ev GKwaK kvLvi cʻqvrBxq Z` Rvbr mʻe bq| wKš` kvLv Awclm ,tjv hv` tbUI qvtKʻ gva`tg tnW Awclmi mʻ½ hʻ ʻvK Zvntj tnW Awclm kvLvi th tKvb Z` ZvrʻwKfite msmŏh KiʻZ cviʻe| Gi cvkvcwK tnW Awclm th tKvb , iazcʻy[©] tNvi Yv `z kvLv Awclm ,tjv tK RvbtZ cviʻe| e`vsuKs-G tbUI qvK[©] mvdj` AvKvPzʻ| Avgt` i t`k cʻʻj Z e`vsʻKi e`e`vq GKvDvU mgwšZ wv` ʻ kvLvi evBti tj bʻ b mʻe bq| tKvb e`vsK Gi t`k Rʻjo Qwotq `vKv kvLv ,tjvi gʻa` hv` Dchʻ tbUI qvK[©] AeKvVtgv `vK, Zvntj MŏhK XvKv eʻtĀ GKvDvU Lʻj wmtjU eʻĀ t_ʻK UvKv DVtZ cviʻeb| Avgt` i t`k AwZ m`uZ GB e`e`v i i`antqtQ temi Kvix GGbtRW Mŏtj R e`vsK Ges ÷`vDw[©] PvUw[©] e`vsK|

ᄡ Ae GWKkb

Avgiv th tμWU Kw^{ev} UvKv Dĕĕj tbi Rb" AĕUvĕgUk tUj i tĕk^b (GUUGg ev ATM) e"envi Kwi tμLvtbi mmei qY Ges eaZv wbjcĕYi Rb" e"eüZ nĕ"Q tbiU qvK^fĕK GucĕKkb| dtj Avcbvi tμWU Kw^{hwi}ĕq tMĕj gĕZ^P gĕa" mgM^{etk}ĕ; tμ Lei tĕĕQ w ĕq, 24 NvUvi gĕa" bZb tμWU Kw^q qv m^e|

Dbz wĕkĕ; e"vsKs m^{svš} hveZiq KvR GLb K^uDUvi w^fĕK GucĕKkb| gva"tg Kiv nq| Gici wĕkĕ; GLb P^j yntZ hvĕ"Q BvUvĕtBU e"vsK| Avcb BvUvĕtBU e"vsĕK GKvDvU L^{jt} H e"vsK-Gi m^{1/2} P^z f^z wĕkĕ; th tKvb e"vsK t^ĕK Avcb UvKv t^j bĕ" b KiĕZ cviĕb|

B-veRĕbm

cY" Ges tmev wĕmĕtqi tĕĕĕ tbiU qvK^{thvM} KiĕQ bZb GK gvĕv| dtj Nĕi eĕmB GKRB tμZv Zvi cY" c^o Kĕi tμWU Kv^w gva"tg `vg cwĕkva KiĕZ cviĕb hvĕK ejv nĕ"Q B-veRĕbm| GgbwK GLb Nĕi eĕmB Dbz wĕkĕ; GKRB b^vMwi K c^o b^x cĕY"i wbjvĕgi WĕK AskM^{hY} KiĕZ cviĕb Ges Zui `vg mĕĕP nĕj AvcbB nĕb Zvi M^e g^{vij} K| Gme tĕĕĕ `i-Z; mgq Ges w^bf^zvĕK GKwĕ Z KĕiĕQ tbiU qvK^q

jvĕĕxi tĕĕĕ tbiU qvK^{etq} GĕĕQ GK h^všKvix cwĕeZ^b| thgb Avĕgwi Kvi jvĕĕxi Ad KĕM^{mi} w^{ef}b^{ai}ĕbi eB, g^vM^wRb, Rvbĕj w^{mv}^{cc}vi c^fwZ. m^{svš} msmni m^{sl}v 6 tK^wiĕ t^{ew}| GB jvĕĕxi Ad KĕM^{mi} w^{ef}b^eZ" GLb K^uDUvĕi m^{sv}ĕ| BvUvĕtBU m^ĕavi gva"tg wĕkĕ; th tKvb `vb t^ĕK GBme Z" msm Kiv m^e| K^uDUvi tbiU qvK^q gva"tg e"env^g aiĕbi jvĕĕxi, t^jvĕK ejv nĕ"Q f^vĕj jvĕĕxi (Virtual Library)| wĕkĕ; eü f^vĕj jvĕĕxi GLb BvUvĕtBUi gva"tg h^y, dtj wĕkĕ; w^{ef}b^cĕĕšⁱ Qvĕ, M^{el}K Zvĕ"i c^oqvRb^x Z" Nĕi eĕmB msmni m^{thvM} cvĕ"Qb|

tbiU qvK^q th me e"envi, t^jvi K^v Avgiv GZ^{qY} AvĕjvPbv Kijvg, G^vĕjv AĕbK Rb^wĕ GucĕKkb| gvĕ KĕqKw| c^zcĕĕ tbiU qvK^{Dbq}b ĕi^e nĕq^{Uj} Avĕgwi Kvi c^ziĕ qv tĕĕĕ M^{el}Yvq djvdj w^{ew}ĕtqi Rb" | GB w^{el}ĕq 1969 m^vĕj c^og mdj Zv AR^b m^e nq| eZ^ĕ Avĕgwi Kvi c^ziĕ qv m^{svš}me `vcbv, t^bĕeni, w^{eg}ibenĕ, `mb", c^ziĕ qv g^švj q, t^{nv}q^{BU} n^vDm GLb tbiU qvK^{AeKv} gva"tg h^y thLvtb Av^gY w^uĕZ nĕ qv gĕZ^P gĕa" c^oqvRb^x c^ziĕ qv e"ĕĕK c^z Av^gĕYi h^{vh} w^bĕ" R R^wĕtq t^q m^e nĕ|

D^gĕ ĕq^v i ĕi

ĕi ĕq^v gva"tg ĕq^v Ges w^{ef}b^cĕĕĕ^{qYĕK} GLbKvi t^tq Avĕ mdj Ges mⁿRfĕ g^vĕi K^vQ t^cĕ^uv^b m^e nĕ| aiv hvK, t^ĕki tKvb w^{ef}v^t w^{ef}b^eRvqM^v c^uĕw w^ĕĕx f^vlv ĕq^v B^w÷w^{DU} AvĕQ| me Kq^w B^w÷w^{DU} nqZ t^ĕlv t^mj d^vmm f^vlv t^klv^bvi ĕq^v t^b| t^mĕĕĕ tbiU qvK^A ĕi f^wel ĕZ G aiĕbi m^ĕav c^ovb Kite th, Qvĕiv w^bR B^w÷w^{DU} eĕmB Ab" B^w÷w^{DU} d^vmm f^vlv c^w M^{hY} KiĕZ cviĕ| ĕay ZvB bq Zvĕv ĕiKvi nĕj thb c^ĕKiĕZ cvĕi t^m m^ĕav c^ovb Kite Av^g w^b ĕi GWKkb tbiU qvK^q Gi c^{ik}v^c me K^uDUvi t^wUvĕR e"envⁱ m^ĕav Zv^vQ^B| Dbz Zi ĕĕ" t^{me}vi Rb" Av^mĕ t^Uvj t^gw^wmb| GB t^Uvj t^gw^wmb t^vixi w^{pv}K^{rm} m^{svš}

hveZxq Z` gúZP gta` Zvi Kbmjv U`wUk tcltQ t`te tbUl qvtKp gva`tg| GB KvR G- -tj, wmlU `vib, Avéš mvdD ucKPri ev G RvZxq hveZxq Z`tK wmlRUvj ifc tbUl qvtKw`tq cvVvb nte hv Kbmjv U`wU D`P qjgZvm`ubregubUti t`Ltz cvteb| tm Abtqvq wZvb tivMxi Rb` h_vh` wPwKrmv wbt`R cvVvteb| GB tUvj tgmwmtbi gj- mjevav nť`Q, wekIÁ thLvfbB_vKb bv tKb ZvtK Avgiv mnťRB tivMxi KvřQ nmlRi KiřZ cvie| Zv Qvov mgMöcixqivi djvdj KivúDUvti i qjYvteqjY evřqv ÷`wmlU÷Km mspvšl MtelYvq wekI mnvqZv Kiře|

wekpe`ij q Ae`vb

wekpe`ij q Gi e`envi nřZ cvti GiKg cŕZw wekpe`ij qvtK WAN-Gi ōviv GřK Actii mřt_ mshš Kiv thřZ cvti| Avi wekpe`ij q, tji v_vKte `Zš; LAN, Gi gva`tg GKB wełtqi wefba wekpe`ij qti Qvř/Qvřxiv wbtRř`i gta` Ávb, Z`, gZvgZ, wełvgřqi weivU mřhvM cvteb| dtj MtelYvgj-K KvR, tji v mKřj i Kvř mnťR Dc`vřtbi gva`tg bZb bZb a`vb-aviYv, wPšř-řPZvri ōvi Dvgš nte| tKvb Rulj GKw wełqřK mgvavřbi Rb` GKřhvřM wefba `řtbi wekpe`ij q/Qvřiv KvR Kivi mřhvM cvteb| t`k weř`tki Ab`vb` wekpe`ij qti mřt_ thvMřhvřM gva`tg cŕB AvavřK ZÉ; Ges Z` tcltQ hvře mKj AvMřx wekpe`ij q ev wekpe`ij q v b Kvix e`w`eřMř KvřQ|

Lg teik w`b AvřMi K_v bq- Ggb GKUv mgq wQj hLb wKQy wKQyeo BDwbFvwmřU wKsev eo eo tKv`úvbx, tji vřZ tgBb tdg KivúDUvi e`envi Kiv nřZ| wKš` GB e`vřviUv ZLb wQj AZ`šře`qeúj | ZvB gmvřtgq wKQycŕZŕv Qvov tgBb tdg KivúDUvi e`envi Kivi K_v tKD wPšřl KiřZ cvřřZv bv| wKš` GLb tclřvřU wřbř mgřqi cvieZřbi mřt_ mřt_ DbřZ nřqřQ tUKřbvřj vRxi | cřhvš i mjevav Gřm hvř`Q gvbtř i nřřZi gřřvq|

A`g` B`Qv kw`i nvj aři gvby cŕli hM, Zvg` hM, ev`ú BwÁb hM tcvřtq gvbe mř`Zv bvřgi ZixřZ Pto AvR cřek KřitQ Hightech Information Age-G hvi mřt_ I ZřcŕZřvře Rvotř AvřQ `w` ká: Computer Network| w`wřwřEK mřL`v ZřÉj Dci wřwřE Kři weÁvřř`i MtelYvi dmj wřmřte cŕq Aa`kZK AvřM AvřřcřKvř KřivwQj th hšřU tmB KivúDUviřK e`envi Kři AvR Mto řZvjv nř`Q wekvj thvMřhvřM e`e`v ev Computer Networking Ges GwUB nř`Q GB Hightech Information Age-Gi gj- wqšřYKZřř evsj vt`ki cŕg temiKvix wekpe`ij q Gb, Gm, BD (NSU) mn Avřl KřqKw wekpe`ij q G třřřř GKw wekI Ae`řtbi iřqřQ| G mg`l wekpe`ij q cŕZw wekpe`ij q Rb` ōŕKivúDUvi wekpe`ij q wekpe`ij q Zvi Pri eQřii wekpe`ij q Rvřřbi Acwřvřh` Ař| Avi Zviv mřhvM cvř`Qb t`řki Ab`Zg tmiv I meřavřK KivúDUvi tmřUvti GB wekpe`ij q MřřYi | NSU wekpe`ij qti cŕq cŕZw KivúDUvi j`vb Gi mřt_ mshš | cřvmb I wekpe`ij q GB `řU třřřřK cŕvřb` wřtg GB wekpe`ij q `řcb Kiv nřqřQ `w` LAN Setup| wekpe`ij q KvR Křib Student Server-Gi mřt_ mshš PC Work Station , tji vřZ| Avi Administrative Server-Gi mřt_ hřř wřwř I qvK`ř-kb, tji vřZ cřvřmbK e`w`eřMř tbUl qvK`G KvR Kivi gva`tg wekpe`ij q v thgb cvřwřZ nř`Qb DbřřZi KivúDUvs Gbvřqi břgřU Gi mřřř Zgřv cvř`Qb břvř i Kg mřhvM mjevav| GKRB wekpe`ij q Zvi wekpe`ij q`i Rb` wbařřř Z GmvBbřgřU, tji v wřtg wřř`Qb mřřřř-Gi GKw Křgvb Gwř qvřZ; Avi gúřřZřvi wekpe`ij q v tmB GmvBbřgřU, tji v tclř hvř`Qb| Solve Kivi ci wekpe`ij q`řm, tji vř Hardcopy wKsev Softcopy Rgv wřř`Qb Zvi cřkřřřKi KvřQ Ges Zvl

tbUI qvK©Gi gva'tgB| Hardcopy0i (Printed Output) Rb" e"envi KitiQb tbUI qvK©
 w0Uvi A_ev Softcopy Rgv w' t"Ob tbUI qvK©Zvi wBR^Gwi qvtZ| Gici c0k0K tmB
 RivMv t_tK Zvi c0E Solved Assignment-Gi i'xZv hiviB KitiQb| weifb0mg0q
 wk0lv_0Z_v e"envi Kivxt` i weifb0mdUI q"vi-G KivR Kivi c0qvRb nq| LAN-Gi mit_
 h0 vKivq Zviv c0qvRbxq mdUI q"viiU th tKiv mg0q mrvf0 t_tK e"envi KitiZ
 civitiQb| weifb0c0Kvi Notice, Broadcast Message, Exam Schedule c0fuz. w' t0
 t` lqv n0"Q Display Area-tZ| dtj GKRb hLbB LAN-G Log in KitiQ mit_ mit_
 tRtb h0"Q H mKj Z_" QvI t` i wk0lv0j-K wbt` Rbv c0vb Kiv n0"Q LAN Based
 Software 0viv| c0kvmibK e"0eM0wb0R t` i gta" gZ weib0gq KitiQb tbUI qvK©e0j w0b
 tevW©Gi gva'tg| c0kvmibK e0 KivR m0ub0Kiv n0"Q LAN 0viv|

eivw0f0k0i mit_ c0Zw0qZ thvM0thvM i 0lv Kiv n0"Q B-tgBj Gi gva'tg| c0B Z_" 0w0t0q
 t` lqv n0"Q mgM0K"v0um G| dtj mg0qi AcPq thgb tiva Kiv n0"Q tZgwb wk0lv_0` i
 KitiQ Dc"vcb Kiv n0"Q Avaj0KZg ZE0I Z_"|



cvtV0Ei gj"iqb: 6.6

A) iPbv0j-K c0k0e

1. tbUI qvK©K?
2. tj vKiv Gwi qv tbUI qvK©ej tZ wk tevSivq? G ai tbi` 0U tbUI qvtK0 bvg wj L0|
3. I qvBw Gwi qv tbUI qvK©K? eY0v Kiab|
4. tbUI qvK©0m0K w0q00 ej tZ wk tev0Sb?

cW 6.7

B>Uvi tBU

Dt`ik`

GB cW tk`l Avrb—

- B>Uvi tBU mK Zv ej tZ cvi tēb;
- B>Uvi tBUi Kvhe`ij x eYv Ki tZ cvi tēb;
- B>Uvi tBUi mKvbn mKfite wj LtZ nq Zv ej tZ cvi tēb;
- I tqe tCR I I tqe mBU mK Zv ej tZ cvi tēb;
- B>Uvi tBU mbqš`Kvi x cŁZv tbi bvg ej tZ cvi tēb Ges
- I tqe `Zni i DcKi tYi bvg ej tZ cvi tēb|

Z` cħny`i t`q`i mek` R`jo e`vcK me`sq miv Kti tQ B>Uvi tBU| GuU BtZvgta` tMvUv cW extK GKU eo Mōtg (Global Village) ifcvšhi Z Kti tQ| B>Uvi tBU GLb mekřevcx Z` cħny`i cŃYtK`` B>Uvi tBU nj Zt`i gnvimgy` meMZ KtqK ermti GuU gvb`i Riebhv`i gvtS mivZ`Kvi At`B GK eo aitbi cwi eZB GtbtQ| Avi Gi cřve iay tKv tbn vbi` t`tki, vbi` RbMtYi Dci GKKfite ctovb, eis Gi cřve mgMōmetk`i RbMtYi DctiB ctotQ| ti mvi, tUvj tdiv, tUvj Mōg meivKQ B>Uvi tBUi RMtZ GK eo aitbi Ae`vb ti tL tQ, ZvtZ tKv m`n tB| G mtei e`envi gj-Z t`stMvj K Ae`vb Ńviv cřveZ ntq v`tK| mKš` tmiv K t`tK B>Uvi tBU thb mgMōmek`K GKB mZvq Ave`Kti tQ, hv AvtM Ab` tKv cħny`i ct`qB tcti DVv m`e nqv| B>Uvi tBUi Kj`vY AvR miv cW ex thb GKU thš` cwi exti cwi YZ ntqtQ| eZv tbi mek`i cŃq GKK mEi v t`tki AvbgvmbK mivto ŃŃtKvU gvb`y B>Uvi tBUi GB mekvj fe`bi evm`v| Avi G mSL`v cŁZv bB evx cv`Q|

B>Uvi tBU mK?

GuU mekřevcx Ńvotq vKv AmsL` KivúDUvi i gta` Avštm`úK`ev thvMthvM e`e`v| tek mKQyKivúDUvi tK tUvj tdiv jvBtbi gva`tg R`jo w`tq `Zni nq GK GKU KivúDUvi tBU qvK` t`z Ktj tRi tQv cwi mti, Rbeúj tKv e``tkni R`jo mKsev Zvi PvBtZI eomo tKv GjvKvq Ńvotq vKv GB tBU qvK` t`j vB nj B>Uvi tBUi cŃve`y Z`z bvgj-Kfite q`z`KvZi GB KivúDUvi tBU qvK` t`j v Avevi th mekvj tBU qvK` Avl Zv f`z ntq ci`úti i gta` Z` Av`vb-cŃvb Kti, tmB mekvj tBU qvK`KB etj B>Uvi tBU| mgMōcW ex R`jo Ńvotq vKv nivrvi nivrvi KivúDUvi (Server) wgtj MvB Kti tQ B>Uvi tBUi Backbone ev tK``q Kivv tgv| GB e`vKt`v tbi cŁZv KivúDUvi Avevi AmsL` KivúDUvi i miv` h`y| GfiteB AmsL` KivúDUvi i mgštq Mto Dv tQ B>Uvi tBU miv`g| A` B>Uvi tBU nj KivúDUvi Rivj | AtbKv gvKomvi Rivj i gtZv| tBU qvK`ev th Rivj cW exi mevfbaRivqMvq Ńvotq vKv KivúDUvi (tmUv Avj v`v Avj v`vB vK` Avl GKm` tRov w`qvB vK`) t`j v`K g`Wg (Modem) tUvj tdiv tbi jvBb Avl miv`Uj vBU w`tq mevi m`z mevi thvMthvM Kivi e`e`v Kti t`q|

B:Uvi tbtUi wPšlavivi Rbŷ nq 1969 mtj | Gtŷŷŷ Kvi YUv iak-gmKŷ Vvŷv j ovB | tm mgq Avtŷm Kvb cŷZi ŷŷv emvbx weŷkl Kŷi wegvb emvbx Ggb GKwU cšv tei Kivi K_v wPšl-fivebv KiwQj thb hŷx i mgq nVvr th tKvb aiŷbi Avŷmgtŷi cŷi l `i-t_tK Zv`i wegvb NwU, tj vŷK wqšŷ Kiv mæe nq | G K_wU cŷg Avŷm gmKŷ mvgwi K w_sK U`vsK i`vŷ Kŷcŷikŷbi GK `eÁvnbK ŷcj e`vŷivbŷ Gi gv_vq | Gi Avŷm gmKŷ mvgwi K thvMŷthvM tbUI qvKwQj mvgwi K U`vsŷKi wKŷj ev tPBŷbi gZ | tPBbUv tKvb GK RvqMvq wQto tMŷj weKj nŷq coZ cŷjiv tbUI qvKŷ gmKŷ mvgwi K weÁvbx cj e`vŷivb cŷjiv cŷ_exi thvMŷthvM tbUI qvKŷ GKwU tPBŷb bv teta GKwU gvQ aivi Rvŷj i gva`tg teta tdj tZ PvBŷj b, hvŷZ Rvŷj i GKwK RvqMvq wQto tMŷj l tbUI qvKŷ e`e`v eRvq ivLv hvq | G weLqW wbtq MŷelYv Kivi `wqZj Acŷ Kiv nq i`wW BŷwUwDŷUi cj e`vŷivŷbi Dci | e`vŷivb Zvi MŷelYv tŷtŷ th wŷtŷvU`tck Kŷib tmLvŷb wZwB gj-Z ŷc`vŷKU mŷwPsŷ bvgK GK cŷhŷŷi K_v Dŷj l Kŷib | thLvŷb wZwB tbUI qvKŷ gva`tg Zŷ`i Av`vb cŷvŷbi Dci , iæZj Avŷivc Kŷib |

B-tgBj

wŷtŷvUŷ gmKŷ wegvb emvbx i nvZ Nŷj GK mgq gmKŷ mvgwi K ms`vi ŷBDGm wWcvUŷŷU Ad wWtdYŷ Gi Aaxb` MŷelYv ms`v ŷA`wWfvY w mŷP`cŷŷŷ GŷRwYŷi [Advanced Research Project Agency (ARPA)] KvŷQ Avŷm | G ms`wU cŷgevŷi gZ hŷivŷŷŷ Pviw wekŷe`ij ŷqi MŷelYv ms`vŷK mŷ_ wbtq GKwU tbUI qvKŷ Pvj yKŷi | Gi bvg ivLv nq AvcŷbU | GB AvcŷbU AvbŷmbKfvŷe Dc`vcb Kiv nq 1972 mtj AvšRwZK Kiv`uDUvi mŷŷŷj b | tm eQŷiB cŷgevŷi gZ B-tgBj tcŷMŷg `Zwi Kiv nq | Giw `Zwi Kŷib tiB wŷgtj bmb | AvcŷbU mŷ_ mŷ_B wŷgtj bmbi tj Lv tmB B-tgBj tcŷMŷg wZv`i tbUI qvKŷ e`enŷi i Rb` MŷhY Kŷi | Avi `ŷ mgtŷi gŷa`B B-tgBŷj i e`enŷi LŷB dj cŷh`wŷmŷe wPwŷZ nq | mŷi `kŷK B-tgBŷj i Av`vb-cŷvb chŷB AvcŷbŷUi e`enŷi mŷgvex wQj | wKŷ` Zv mŷŷj AvcŷbŷUi GB mŷdj `ŷK GKwU eo gvBj dj K wŷmŷe wPwŷZ Kiv nŷq wQj | Avi ZvB wekŷj evŷRŷUi GB AvcŷbŷUi e`enŷi AUŷ_vŷK | KŷqK eQŷi i gŷa`B AvcŷbŷUi mŷ½ hŷ nŷZ `iæ Kŷi hŷivŷŷŷ Ab`vb` A½ivŷR`i MŷelYv ms`v l wekŷe`ij q, tj v | GK mgq ciivŷ`Bi AvcŷbŷUi Dci t`ŷK KwZcq evav-wŷtŷa Zŷj wŷtj ŷouŷo Kŷi Gi mŷ½ Avŷivl mŷaviY wekŷe`ij q, tj v hŷ nŷZ `iæ Kij | Avi ZLbB gj- AvcŷbŷUŷK tŷtŷ`ŷŷv fvŷM fvM Kiv nj : GKwU nj wŷj tŷU Ges AvŷiKwU nj AvcŷbŷU | wŷj tŷU mvgwi K `vcbv, tj vi gŷa` mŷthvM mŷaŷbi Rb` Avi AvcŷbŷU mŷaviY e`enŷi Kvŷx`i Rb` Dbŷŷ Kiv nj |

GfvŷeB tKŷU tMj tek KwU eQi | Avki `kŷK Gŷm AvcŷbŷU GK eo aiŷbi cwieZŷ nq | 1980 mtj GKwU bZb tbUI qvKŷ`Zwi nj, hvi bvg GbGmGdŷbU (National Science Foundation Network) | tm mgq cŷhŷŷi DbwZi dŷj GK wŷtŷŷgi Kiv`uDUvi PvBŷj Ab` wŷtŷŷgi Kiv`uDUvŷi mŷ_l thvMŷthvM KiŷZ cviZ | 1983 mtj Gŷm cŷq me tbUI qvKŷ wŷmŷc Ges AvBwŷŷZ iŷcvŷŷi Z nŷZ `iæ Kij | Gi dŷj `iæ nq bZb GK hŷMi Ges cvkvcwŷk AvcŷbŷUi Dci wŷfŷŷkŷj Zv nŷm tŷŷZ_vŷK | 1990 mtj hŷivŷŷŷ mvgwi K ms`vi wŷt`ŷk GB AvcŷbŷUi wej wŷ NŷU | Avi GfvŷeB `iæ nq AvRŷKi emŷwR`K B:Uvi tbtUi hvŷv |

tUj tBU: Gi gva`tg Avciab Avcbri KivúDUviúUk BvUvibtUi gva`tg Ab` GKúU KivúDUviti m½ mshʻ Kti tmiúUk e`envi KitZ cvtib| tmʻŋtĀ Avcbri KivúDUvi cĀvbZ GKUv Uvngŋvtj i gtZv AvPiY Kiŋe| th KivúDUviti mvt_ Avciab mshʻ nteb ZvtK ej v nq vi tgvU tnv÷ Ges Avcbri úUk ej v nte Uvngŋvj |

dvBj UvYdvi tĀUkKj ev GduUc (File Transfer Protocol or FTP): GiU Ggb GKúU tĀUvUkKj hvi gva`tg Avciab GK KivúDUvi t_úK Avi GK KivúDUviti dvBj Av`vb cĀvb KiúZ cvtib| dvBj ej tZ tĀUg, tU· U, ucKpvi BZ`w` tevSvq| mZivs FTP Gi gva`tg th tKvb tnv÷ t_úK cĀqvRbxq dvBj AvZ mnúR Avcbri nWúMú` Kic Kti AvbúZ cvtib|

ARCHIE: Archie AvcbvúK AmsL` dvBj t_úK ubw`ŋ dvBj úUk LúR tĀZ mrvh` Kiŋe| Zte tnv÷ Ges Uvngŋvj Dfq KivúDUviti Archie _vKúZ nte|

Internet Relay Cat (IRC): Gi gva`tg e`envi Kivixiv ubúRt` i gta` Kx tevúWp mrvh` Avjvc KiúZ cviteb|

Iúqf mrvŋ: mrvŋ gj-Z GKUv AZ`šĀ žZMúZ m=úbæel kiv³kij x KivúDUvi umt÷g| th KivúDUviúU BvUvibtUi mvt_ mveŋWYKfite hʻ t_úK Ab`vb` KivúDUviti mvt_ BvUvibtUi msthvM Nuúq t`q ZvtKB mrvŋ etj | GB mrvŋúU GKúU tUvj tĀvb j vBúbi gva`tg `vqxvite BvUvibtUi mvt_ hʻ _vúK Ges mvari YZ w` bivZ 24 NvUvqB GB j vBb mPj _vúK| mnR K_vq, Iúqf mrvŋi i KvR AúBKUv tUvj tĀvb G· tPúAi gZ, Gi mvt_ mshʻ nte Avciab cĀ_exi wevfbaRvqMvq thvMúthvM KiúZ cvtib|

Iúqe tĀR (Web Page): Iúqe K_vUvi A_úRij ev cŋvj Z BstúR fvlvq tBU| Iúqe tĀR ej tZ tevSvq BvUvibtUi mvt_ tRvov t`qv AvúQ Ggb GKúU kiv³kij x mrvŋ thLvúb ivLv nq tKvb e`w³ ev cĀZŋvbi cwiúPúZgj-K Z_`vej x, weÁvcb, Z_`vPĀ, cwiúmsL`vb BZ`w` | KúqKúU Iúqe tĀRi mgšúq `Zwi nq GKúU Iúqe mvBU (Web Site)| Iúqe tĀR `ZwiúZ GKúU weúkl aiúbi fvlv e`eüZ nq, ZvtK ej v nq GBPúUGgGj (HTML)| cĀZúU Iúqe mvBúUi GKúU ubw`ŋ wKvbn _vúK| Iúqe mvBúUi wKvbn t_úK me Z_`B tRúv úbúZ cvtib| G thb AúBKUv Kvúv emúúMúq Zvi m=úúKúRvbevi gZ GKUv e`vcri | Gi Rb` GúK tnvq tĀRI (Home Page) etj | BvUvibtUi wevfbaAsk AvúQ| mePvBúZ Rvúcbŋ nj World Wide Web (mstŋtĀc WWW)| Iúqe Núji teovevi Rb` th me tĀUg AvúQ (G_új vúK Iúqe eúDRvi etj) tm_új vúK e`envi Kti th tKvb tj vúKi ev cĀZŋvbi Iúqe tĀR t`Lv hvq|

tMUI úq: tMUI úq nte`Q Ggb GKúU KivúDUvi hv`úU tBU qvúKp gta` Ae`vb Kti | GúK tMUI úq ej vi Kvi Y nte`Q GiU GKúU tBU qvúKp Z_` ev tWúvúK Ab` tBUqvúKp DcúthvMx Kti Z_` Av`vb-cĀvb KiúZ A_úR BvUvibtU msthvM Puj yivLúZ mnvqZv Kti | thgb evsj v`k t_úK cĀ_exi Ab`me t`úK BvUvibtUi gva`tg thvMúthvM Kivi tŋtĀ Táu tMUI úq unúte KvR Kti |

փ Ae GW#Kkb

e`envi: B>Uvi#bU c0Z`inK Rxe#b KvRKtg©G#b#Q `ec#eK cwi#eZ#| gub#y GLb Z_`
c#h#y# i GK Amvavi Y mvd#t#j `i k#t#l`©Ae`vb Ki#t#Q| me#k#b c#h#y# I tgavi mg#s#t#q `Zwi
Kiv AZ`#s#l Kiv#R#ix I M#z#k#x#j mdUl q`vi B>Uvi#bU#t#K K#t#t#Q mvd#j `g#b#Z I AZ`#s#l
Rb#i#c#q, th_#t#j#v Av#q#v#t`i KvRKg#k#k mnR, m#y#i I `e#l#P#I#g#q Kivi Rb` Amvavi Y| Gi
e`env#t#i#i d#t#j mg#q th#b#b t#e#l#P h#v#t`Q, t#Z#g#b e`envi Kiv#l# n#t#q DV#t#Q `#q I Kg#e#U#z GB
m#i#k#t#q# I `y#s#l M#z#k#x#j B>Uvi#bU Av#q#v#t`i K#v#u#D#U#ri e`envi#t#K K#t#t#Q e`vc#K#Z#i |

B-#g#B#j e`envi K#t#i L#y# m#n#t#R#B Kg mg#t#q c#l#_#e#i th t#K#v#b `v#t#b Ri#i#x e#v#Z#P#A#v`vb-c#0#v#b
m#e#e#|

I#t#q#e `Zwi i Dc#K#i#Y: L#y# m#v`v#g#v#U#v I#t#q#e t#c#R `Zwi Ki#t#Z h#v`i Kivi Z#v#j I q#v#W#c#0#m#m#i,
g#t#W#g Ges B>Uvi#bU m#s#t#h#M#| g#v#i#e#g#v#W#q#v (t#m#L#v#b Q#i#e, t#j#L#v, k#ā# m#e#B`_#v#K#t#e) I#t#q#e
t#c#R `Zwi Ki#t#Z P#v#B#t#j I#t#q#e A_#w#i#s U#z#m#&(th t#c#0#M#g# v`#t#q I#t#q#e t#c#R `Zwi Kiv h#v#q)
e`envi Kiv D#v#P#Z| G#t#q#t#I HTML Gi L#y#b#v#U# v#k#L#t#Z n#q#b#v#|



cv#W#E#i g#j`v#q#b: 6.7

A) i P#b#v#j#-K c#k#e

1. B>Uvi#bU #K?
2. #U#v#f I B>Uvi#b#t#U#i g#t#a` c#v`_#R` #K?
3. B>Uvi#bU t#K #b#q#s#y# K#t#i?
4. B>Uvi#bU #K#v#b#v# #K?
5. B>Uvi#bU #K#v#b#v# 0#v#i#v #K t#e#v#S#v#q#?
6. g#t#W#g #K?
7. B>Uvi#bU e`envi Kiv#x# t#U#j#t#d#v#b#j#v#B#b e`envi K#t#i t#K#b#?
8. B>Uvi#bU m#s#t#h#M# #b#t#Z #K #K Dc#K#i#t#Y#i c#0#q#v#R#b#n#q#?
9. LAN Ges WAN #K?
10. t#U#j#t#b#U# e#j#t#Z #K t#e#v#t#S#b#? t#U#j#t#b#U# e`envi Ki#t#Z #K j#v#t#M#?
11. A#v#B#A#v#i#m# e#j#t#Z #K t#e#v#S#v#q#?
12. I#t#q#e t#c#R I I#t#q#e m#v#B#U# e#j#t#Z #K t#e#v#t#S#b#?
13. GBPG#g#v#U#G#j #K?
14. t#M#U#I#t#q# #K?
15. I#t#q#e `Zwi#t#Z #K #K Dc#K#i#Y# e`envi Kiv n#q#?

B-tgBj ᄀKfite KvR Kti?

B-tgBj AtbKUv Avgt̃i t̃tki ᄀRᄀcl e. t̃tK ᄀPᄀW Avbvi gZ| hLb Ljx ZLb ᄀPᄀW
cvVt̃bv hvq| ᄀPᄀW, t̃jv c̃c̃t̃Ki ev. ᄀM̃tq Rgv ᄀvK̃te| c̃c̃K thw̃b ev. Lj̃teb,
tm̃w̃bB ᄀPᄀW, t̃jv t̃c̃t̃q hṽteb|

B-tgBt̃j Z_ cvVt̃Z GK c̃c̃t̃šī KᄀúDUṽt̃i m̃t̃½ Aci c̃c̃t̃šī KᄀúDUṽt̃i m̃st̃hṽt̃Mi
`iKvi t̃bB| ᄀKŠ' B-tgBj cvVt̃bvi c̃c̃q̃Rbxq Ab" meᄀKQB ᄀvK̃t̃Z ñte| G Ae ᄀvq XṽKv
t̃t̃K Aṽt̃g̃wi Kvq B-tgBj cvVt̃j ZLb miṽm̃wi cvVt̃Ki Kṽt̃Q P̃t̃j hvq Avevi At̃bK t̃ᄀt̃
c̃c̃t̃g B-tgBj ᄀU ᄀM̃tq t̃c̃c̃t̃e XṽKvq Aeᄀ'Z B>Uṽt̃bU t̃meṽvbK̃vix m̃s̃vi m̃ṽf̃t̃i
(KᄀúDUṽt̃i)| Gici Zv ᄀeᄀfb̃em̃ṽf̃t̃i Ñt̃j c̃c̃K Aṽt̃g̃wi Kṽi th B>Uṽt̃bU m̃st̃hṽt̃MK̃vix
m̃s̃vi m̃ṽt̃ m̃sh̃ᄀ Zvi m̃ṽf̃t̃i ᄀbw̃ᄀ t̃gBj ẽt. Rgv ᄀṽt̃K| c̃c̃K hLb KᄀúDUṽt̃i
g̃vãt̃g Zvi GKṽD>U b̃vg, Zvi c̃ṽm̃l q̃ṽW̃ᄀ t̃q Zvi t̃gBj e. t̃PK Kĩte, ZLbB Zv Zvi
KᄀúDUṽt̃i P̃t̃j hvq| Avi GB c̃t̃j̃v c̃c̃q̃m̃U m̃=úb̃ẽñt̃Z mgq j̃ṽt̃M g̃ṽt̃ K̃t̃qK t̃m̃t̃K̃D|
Z̃te c̃c̃K KLb Zvi t̃gBj e. t̃PK Kĩte t̃m̃U Zvi ᄀbR̃^ẽṽc̃vi, Avi Zvi DciB ᄀb̃f̃ᄀ
Kĩte t̃m̃ KLb Aṽcb̃vi cvVt̃b̃v B-tgBj ᄀU cṽte| Aṽc̃ub̃ hLb t̃Kṽb t̃gBj M̃h̃Y K̃t̃ib ZLb
ᄀK GKB c̃c̃q̃ṽ KvR K̃t̃i |

Aṽg̃iv GB Ãst̃ki m̃vĩsk ᄀbg̃ẽf̃c ᄀj L̃t̃Z c̃vi –

B-tgBj AtbKUv W̃w̃K ẽẽvi g̃ZB KvR K̃t̃i | hLb t̃KD t̃gBj K̃t̃i Zv GKᄀU t̃gBj
m̃ṽf̃t̃i Rgv ñq ᄀPᄀW̃i ev. t̃t̃K thgb ᄀPᄀW̃ ᄀvb̃xq W̃w̃KÑt̃i Rgv ñq| Gici ᄀPᄀW̃ th̃f̃it̃e
GK t̃c̃v ÷ Ãwd̃m t̃t̃K Ab" t̃c̃v ÷ Ãwd̃m cvVt̃b̃v ñq t̃Zgñb t̃gBj m̃ṽf̃t̃i cvVt̃b̃vi AṽM
ch̃š̃ Ãṽq̃ṽit̃e Rgv ᄀṽt̃K M̃š̃t̃ẽi t̃gBj m̃ṽf̃t̃i | M̃š̃t̃ẽi t̃gBj m̃ṽf̃t̃i t̃c̃c̃t̃ẽvi AṽM
ch̃š̃ GB t̃÷vi G̃D dĩl q̃ṽW̃ᄀm̃B̃t̃Kj P̃j t̃Z ᄀṽt̃K| t̃Kṽb g̃ṽt̃m̃R̃ eṽ eṽZ̃P̃M̃š̃t̃ẽi t̃gBj
m̃ṽf̃t̃i t̃c̃c̃t̃j̃ Zv t̃m̃Lṽt̃b̃ m̃sĩᄀZ̃ ᄀṽt̃K h̃Z̃ᄀỸ b̃ṽ c̃c̃K Zvi B-tgBt̃j̃ i t̃gBj e.
t̃PK K̃t̃i Zv M̃h̃Y K̃t̃i |

eZ̃g̃ṽb mg̃t̃q B-tgBj ᄀt̃k̃j̃ mẽt̃P̃t̃q ᄀf̃ẽq̃x thw̃Ṽth̃ṽt̃Mi g̃vãg̃| t̃d̃vb̃ eṽ d̃ṽt̃. i t̃ᄀt̃
ᄀt̃Z̃j̃ Dci ᄀb̃f̃ᄀ K̃t̃i A_ c̃c̃ṽb Kĩt̃Z ñq, ᄀKŠ' B-tgBt̃j̃ i t̃ᄀt̃ t̃m̃ iK̃g t̃Kṽb ẽṽc̃vi B
b̃q| GLṽb t̃t̃K XṽKvi th t̃Kṽb ẽṽt̃K GKᄀU B-tgBj cvVt̃Z th LiP̃ ñte, Aṽt̃g̃wi Kṽi
th t̃Kṽb ᄀṽt̃b B-tgBj cvVt̃Z̃I t̃m̃B GKB LiP̃ ñte| Z̃te B-tgBt̃j̃ i m̃ṽt̃R̃i Dci
LiP̃Uṽ ᄀb̃f̃ᄀ K̃t̃i, A_ ᄀ eṽZ̃ᄀU KZ̃ eo Ges KZL̃vb̃ mgq ᄀb̃t̃"Q Zv GLṽt̃b , ĩz̃c̃Ỹᄀ

t̃KD Aṽcb̃ṽt̃K B-tgBj cvVt̃j̃ ᄀK̃Q̃ỹLiP̃ K̃t̃i t̃m̃U M̃h̃Y Kĩt̃Z ñte| KṽiY B-tgBj ᄀU
c̃c̃t̃g B>Uṽt̃bU t̃meṽvbK̃vix m̃s̃vi m̃ṽf̃t̃i iṼL̃ṽ Aṽcb̃vi t̃gBj ẽt. Rgv ñte| t̃m̃, t̃j̃ṽt̃K
ᄀb̃t̃R̃i KᄀúDUṽt̃i ᄀb̃t̃q Aṽm̃t̃Z ñt̃j̃ ᄀṽf̃w̃eK̃f̃it̃eB Aṽcb̃ṽt̃K B>Uṽt̃b̃t̃U j̃M B̃b̃ Kĩt̃Z
ñte| Avi j̃M B̃b̃ Kĩt̃Z ñt̃j̃ B Aṽcb̃ṽt̃K ᄀej̃ w̃t̃Z ñte| Z̃te t̃m̃Uṽ L̃ᄀB̃ m̃ig̃ṽb̃ Avi Zv
Q̃ṽoṽ Aṽc̃ub̃ hLb B-tgBj cvVt̃ẽb ZLb Aṽc̃ub̃ Aṽcb̃vi t̃gBj e. t̃PK K̃t̃i ᄀb̃t̃Z cṽt̃ib̃|
B-tgBj mgq I Ãt̃_ᄀ Acẽq̃ t̃t̃K g̃ṽb̃ỹt̃K ẽm̃P̃t̃q̃t̃Q| ᄀt̃k̃j̃ ÃM̃W̃Ỹ c̃vĩevi B-tgBj
ẽẽñvi Kṽix̃t̃ i KṽZ̃ṽt̃i m̃ñg̃j̃ ñt̃"Q| c̃K̃Z̃c̃t̃ᄀ B-tgBj g̃ṽb̃ỹt̃K mg̃t̃q̃i m̃ṽt̃ Z̃j̃ ᄀg̃ij̃ t̃q̃
P̃j̃vi t̃ᄀt̃ GKᄀU eo g̃ṽB̃j̃ dj̃K Ãw̃Z̃ᄀg̃ Kĩt̃Z m̃ñṽq̃Z̃ṽ Kĩt̃Q| Avi G KṽĩỸB̃ Z_
Aṽvb̃-c̃c̃ṽt̃bi th t̃Kṽb g̃vãt̃gi t̃P̃t̃q̃ AṽR̃ B-tgBt̃j̃ i R̃b̃w̃c̃q̃Z̃ṽ At̃b̃K At̃b̃K t̃ẽiK Ges
Gi ẽẽñvi Kṽix̃i m̃s̃L̃ṽl̃ w̃b̃ w̃b̃ t̃ẽto P̃j̃t̃Q|

WwK wefvMi gva`tg GKuW wPw (tcr÷vj tgBj) cvVtZ PvBtj thgb cÜK I tcÜtKi bvg wKvbn `úov`ti wbf`fvte wj LtZ nq| tZgub B-tgBtj i RMtZ (mvBevi t`úm bvtg eÜj cPwj Z) GK e`w³ (cKZct`q KuvúDvri) Ab` e`w³i KvQ mdj fvte B-tgBj cvVtZ PvBtj wbf`fvte tcÜK I wekI Kti cÜtKi B-tgBj wKvbn tj Lvi cÜqvRb nq| tcr÷vj tgBtj i t`q`i A`bK mgq wKvbn Am`úYfvte wj Ltj I WwK wcb Zvi e`w³MZ cwi wPw I Awf`AZvi Kvi`Y mWV`v`b wPwW tcÜQ w`tZ c`ti | wKŠ`B-tgBtj i t`q`i tm iKg wku`j Zv Avt`Šl MhY`thvM` bq| tKvb wPw cÜtKi KvQ tcÜv`v`b m`e bv ntj WwK wefvM tmUv tcÜtKi KvQ tdiZ cWvtq t`q| tZgub B-tgBj Av`vb-cÜv`bi t`q`i e`üZ mdu` q`vi w Awewj KZ.B-tgBj tcÜtKi KvQ cWvtq t`q| wK Kvi`Y tdiZ cvVt`bv ntj v tmUvI Rwb`q t`l qv nq|

B-tgBj wKvbn

cÜZw gvb`ti cwi`P`ti Rb` thgb Zvi bvg `v`K, cÜZw tUw`tdvb tm`Ui thgb b`f `v`K, wK tZgub cÜZ`K B-tgBj e`envi Kixi GKuW B-tgBj wKvbn `v`K| GK bvtg GKwaK tj vK `v`KtZ c`ti wKŠ` GKuW B-tgBj wKvbn wekI i`agv` GKuW tj v`Ki B `v`KtZ c`ti | A`b`K B-tgBj wKvbn`K f`ekZt B-tgBj b`f etj `v`K| cKZct`q B-tgBj b`f etj wKQy`b| B-tgBj wKvbnB n`Q mWV` fvlv| GKuW B-tgBj wKvbn c`v`bZ `w` Ask `v`K| thgb- user-name@domain-name| GB `w` A`stki gv`S GKuW @ (at the rate of) GKuW wP`y `v`K| D`vni Y sadik@bangla.net GKuW B-tgBj wKvbn| @ wP`yi evg w`tKi Askw`K BDRvi-GKvD`U bvg ev BDRvi AvBwW (BDRvi-AvBwW case-sensitive bq) ejv nq Ges @ wP`yi Wwbn`tKi Askw`U ōtWt`gBb tbgō bvtg cwi wPZ| ōtWt`gBb tbgō Avevi `w` A`stk wef`³ | wU (.) Gi cō`g Ask n`Q B`vvi`tbU tmev cÜv`Kvix ms`vi cwi wPwZgj-K wR`^bvg Ges wU (.) Gi tk`l i Ask w`tq Gw` wK ai`bi cÜZövb Zv w`b`R Kti | thgb: wK`v`v cÜZöv`bi Rb` (.edn), mvgwi K ewv`bxi Rb` (.mil), miKvix Awd`mi Rb` (.gov), Avš`Rw`ZK cÜZöv`bi Rb` (.int), e`emwqK cÜZöv`bi Rb` (.com)|

A`bK B-tgBj wKvbnq ōtWt`gBb tbgō Gi ci Av`ti Kw`U tKvW `v`K hv w`tq tevSv hvq B-tgBj wKvbnwU tKvb t`tKi A_`w` KvwU` tKvW `v`K| thgb: w`w`v`c`ti i Rb` (.sg), Rv`v`bi Rb` (.jp), A`t`÷`ij qvi Rb` (.au), KvbWvi Rb` (.ca)|

B-tgBj wKvbn Wwbn w`tK t`tK co`Z nq|



cW`v`i gj`v`q: 6.8

A) iPbv`j-K c`k`e

1. B-tgBj wK?
2. B-tgBj tKb e`envi Kiv nq?
3. B-tgBj I d`v` -Gi cv`R` wK?
4. B-tgBj e`env`ti i wbgg wK?
5. B-tgBj wKfvte KvR Kti?
6. B-tgBj wKvbn wKfvte wj LtZ nq? wKvbn A_`w`K?

c0qvRbxq Mtel Yv KtgP we`miz weeiY, wPImgr wKsev wefbae AvbywzK Z`w`
KwudUvi tbUI qvK©e`envi Kti ZrYvYr msMh KiZ cvtib| weAvbix`i G AvKvLv
ciYi Rb` wZwb Ggb GKwU tc0M0g `Zwi Kivi K_v wPŠi Ktib, hvi gva`tg Zt`i
Av`vb-c0vb Avtiv mnRZi ntq DVte Ges mnR Dcvtq wekvj AvKvii Z`mgr cov
m`e nte| G iKg GKwU tc0M0g `Zwi K_v wPŠi KiZ wMtqB Zvi gtb cto hvq eUw`b
AvM `Zwi Kiv 0GbKvqvwi 0 bvgK tc0M0gUi K_v| thwU w`tg wZwb AtbK_sjv Zt`i
GKwUk AciuUi mvt_ hY KtiwQtb| Avi G tc0M0gUi Dci wfiE KtiB wZwb
wmbAviGb-Gi Rb` 1998 mvtj c0g tMevj nVBcvi tu. UwfiEK Ggb GKwU tc0M0g
wjtLb hvi ga` w`tgB gj-Z Iqv`I qvBW I`qtei hv`v`i`æ`nq| wUg wbtRB c0g Iqv`I
IqvBW I`qtei Rb` tc0M0g tjLb Ges GKwU eDRvi `Zwi Ktib| 1990 mvtj i
A±vefi GwU c0`ugKfite cixYv Kiv nq Ges wMtm`ti wmbAviGb Zv`i KvRi Rb`
GwU e`envi Kiv i`æ`Kti| 1991 mvtj t`k GwU Bwvibtu e`eüZ ntZ `v`k| 1992
mvtj wUg AvbqmbKfite G`k 0I qv`I qvBW I`qte0 bvtg AwfwnZ Ktib| Dtt` th, wUg
evb`m j`k Zvi GB Abb` Ae`v`bi Rb` Iqv`I qvBW I`qtei Rb`vZv etj AwfwnZ
Kiv nq| `k eQi cti G`m AvR`k I`qte`k wepebv Kiv nt`Q mg`qi meP`q_sæZcy©
D`m`eb wntmte| G`k Zj`bv Kiv nt`Q_sUbv`mP wcbUs tch, M0vng tetj i tUw`tdvb
Ges gv`kmbi tiwU Avwe`v`ti i m`t`|

`f mg`qi g`a` GwU wekpe`vcx KwudUvi tbUI qvK©0Bwvibtu0-Gi AZ`š c0qvRbxq
Avb`y` cwiYZ nq Ges Iqv`I qvBW I`qte (world wide web) bvtg mvariYi gv`S
Rbwc0Zv jvf Kti| mst`q`c I`qte BwvibtuUi wecy Z` m`v`i t`k c0qvRbxq Z`wU
tPrtLi cj`k Avcbvi mvgtb nvr`i KiZ www Gi tKvb Rwp`tbB|

I`qte nt`Q Ggb GKwU weiq hv I`qtegv`vi KZR.e`e`vcvri Rb` `Zwi Kiv nt`Q|
I`qtegv`vi`i DvPZ gvby`k I`qtemvBtu KihRi e`envi m`ut`k`mPZb Kiv|

I`qte`k Avcbvi c0Z0v`bi `cP wntmte wepebv Kiv DvPZ| I`qte Avcbv`k wv wRvBtbi
m`thvM c0vb Kti| thgb, BwAvbqvwi s tKv`v`mbi t`q`T mgm`vU nt`Q th, wKfite
BwAvbqvwi s Gi m`t` tmj mg`vb m`u`3 Kite| mvariYZ t`Lv tM`Q BwAvbqv`i iv th wRvBb
Kti Zv gv`k0s wv`vU`q`Ui tj`v`Kiv eS`tZ cvtibv|

I`qte G mg`l` w0š jvNe Kite| Avcwb hv` `vU`c0KŠkjx nb, Zvntj Avcbvi Kv`Q
WK`gU Av`Q, hv tmj m I`qtemvBU Ges BwAvbqvwi s I`qtemvBtu wj ¼ KiZ cviteb|
GKRb tmj mg`vb GLb mn`RB RvbtZ cvite tKb Ges wK D`t`k` GKRb BwAvbqv`i GB
wRvBbU Ki`Qb|

AZ`š Rbwc0 I mn`R e`envi`thvM` GKwU I`qte mdUw` q`vi ev eDRv`i`i bvg tgvRvBK
(Mosaic)| 1993 mvtj gvK©GwU`mb-Gi `Zwi G eDRv`i`wU`k evRvRvZ Kti hY iv`to`f
Bvj`bq wekpe`ij`q Aw`Z b`v`k`bv tm`v`i di mg`vi KwudUw` Gw`c`k`k`b| eDRv`i`wU
evRv`i Avmri ciciB I`qte e`envi`i Rbwc0Zv Povš`i`c wbtq`Q| Ab`w`k` G cš`q
Z` c0v`i mnR I m`j`f`n`l`q`v`q we`k`j`i wef`bami`Kw`i I ew`v`w`R`K c0Z0vb, c0Kv`bv ms`v,
wekpe`ij`q`i jvBte`fx wKsev e`w`3MZ ch`q`l A`b`k` tnv`g tcBR (Home Page) Gi

tMvdvi

tMvdvi Gi gva`tg Arcıb AıZ mntR tnv÷ KııúDUvi t_řK dvBj Kııc KiřZ cviřeb Ges Zř`i Ar`vb cřvb KiřZ cviřeb| Avi GKıU eo mııev nř`Q GıU w`řq Arcıb GKıU ııc ııKsev řUj řbU Session I Pıj vřZ cviřeb| Zře Gi Rb` tnv÷ KııúDUvi tMvdvři i Rb` cřqıRbxq mdUI q`vi _vKřZ nře|

I řqe řcBR

BıUvi řbU e`envi Kviř`i ř`Lvi Rb` weřfbet`řki mřfři i vLv dvBj řK Web Page eřj | GıU HTML řvıřq řj Lv nq|

řnıř řcBR

řKıv e`ııři/řKııúıvxi ıbR`^Web Page řK Home Page eřj | GıU mřvıYZ Start Page G řmU Kiv _vřK| e`envi Kviři KııúDUvi řh Web Page ıU Start Page ııřmře řmU Kiv _vřK e`envi Kviři H Web Page ıU řnıřřcBR|



cıřVvři gj`ıqb: 6.9

A) i Pıvıřj-K cřkæ

1. I qıı 9 qıvBW I řqe ııK?
2. I qıı 9 qıvBW I řqře ııK ArřQ?
3. I qıı 9 qıvBW I řqe e`envi KiřZ ııK ai řbi mdUI q`vi e`envi Kiřeb?
4. I řqe eřDRvi ııK?
5. tMvdvi ııK KıřR e`envi Kiv nq?
6. I řqřei RbK řK? ııZııb ııKfvře GıU `Zııi Kři b Zv eYřv Ki ab|

cW 6.10

**gwiëngiWqv I umiW
Dfīk**

GB cW tkfI Avcib—

- gwiëngiWqv I gwiëngiWqv ucim iK Zv e˘vL˘v KižZ cvižeb;
- gwiëngiWqv I Rb˘ cŃZKZ.tcŃMŃgi big ejžZ cvižeb;
- nivBcvi iŃ ¼ iK Zv e˘vL˘v KižZ cvižeb;
- gwiëngiWqv I mvdŃj ˘i KviY e˘vL˘v KižZ cvižeb Ges
- umiW umiW-ig I wvfvW iK Zv e˘vL˘v KižZ cvižeb |

gwiëngiWqv

gwiëngiWqv ktāi A_Ńj AŃbK, tŃv gva˘gi mgvivi | GžZ GKB mŃ½ tŃ Lv, Qme, kā Ges Pj šl Qmei mgvitek NUvŃbv nq | Zte gwiëngiWqv ucim ejžZ hv ešvq Zv ntŃv Ggb GKiu ucim hv ntžZ Avcib Rxeš ktāi cŃZdj b cvižeb | GiW Avcbvi gubUŃi dŃ ˘Ńb, dŃžtŃgkb gvf PŃj vžZ mŃŃg, Qme nte ev˘Ńei gžZv, hv Avcbvi gubUŃi GKiu uUvŃmŃŃU cniYZ KižZ cvižeb, hvžZ Avcib KvŃRi cvkvvuk uUvŃ tcŃMŃgi DcŃfvM KižZ cvižeb | A_Ń KivúDUvŃi gwiëngiWqv ejžZ tmB cŃhŃžK vbŃ ˘R KŃi hv GKB mŃ½ tU˘ U, Mānd˘, GubŃgkb, mivDŃ Ges dŃž tŃgkb wfvW I i mgšŃq Z˘vej x Dc˘vcb KŃi |

hvi v Dbž mivDŃ I Mānd˘ K˘vcviej uUmn AvbŃ˘ i Dm wntmte Ń˘LžZ Pvb ZvŃ˘ i Rb˘ ŃgwiëngiWqvŃ GKiu Avž cŃŃqRbxq uRiŃ | mivúŃZK mgŃq eŃŃ tŃgkb cŃZKvix cŃZŃv, tŃv ZvŃ˘ i cŃZ˘Kiu KivúDUvŃi i mŃ˘B gwiëngiWqv mŃŃhRb KižQ | tmB mŃ˘ cŃZ˘Kiu ucim ntŃq DŃvŃQ GKiu gwiëngiWqv ucim | AZ˘vaybK igDvRK, wntbgr I GWžKkŃbi mŃear NŃi eŃm tctž ntŃ Avcbvi ucimUŃKI GKiu gwiëngiWqv ucimžZ cniYZ KižZ nte |

gwiëngiWqv e˘envi KŃi AvKRvŃ bŃbv iKg tLŃv, iKŃŃvŃg-K tcŃMŃg, iekŃKvI RvZxq tcŃMŃg ˘Zvi Kiv nq | Gme tcŃMŃgi gŃa˘ Avevi nivBcvi iŃ ¼ (Hyperlink) bŃŃg GK aiŃbi e˘v˘vŃK hvžZ iekŃfvŃe iŃPvŃZ ktā gvDm wŃŃq iK KŃiŃ H ielq mŃŃŃ AvŃiv bZb K˘v RvŃv hvq | thgb aiab, AvBRvK vbDUB mŃŃŃ GKiu tŃ Lv coŃQb | GB tŃ Lvi gŃa˘ nqZ Ń˘LžZ b ga˘vKIŃ kāUv Ab˘ GK iŃ0 tŃ Lv ntŃŃQ | ZLb GB kāUvi Dci gvDm wŃŃq iK KŃiŃ Avcib ga˘vKIŃ mŃŃŃ Ab˘ GK tŃ Lvq PŃj hvžeb, tmLvŃb ga˘vKIŃ ielŃq iekŃŃi Z RvŃv hvŃe | A˘ev nqZ vbDUB mŃŃŃ tŃ Lvq Ń˘LžZ b GK RvqŃvq GKiu AvBKb ev cŃžxK iŃPŃ Ń˘qv AvŃQ tmUvi Dci iK KŃiŃ vbDUŃbi GKiu Qme Ń˘LžZ tctŃb |

gwiëngiWqv mvdŃj ˘i mŃŃŃŃq eo KviY nj GžZ e˘eŃŃK AvKIŃxq Kivi Rb˘ bŃbv aiŃbi gva˘g e˘envi Kiv nq | thgb GKiu tRU iekvŃbi Qme Ń˘LvŃvi cŃŃqRŃb tRU GgGW tcŃMŃg

megvbiUʻK Pj ší Ae`vq t`Lvʻtj tmUv teik AvKIʻvq nte; Zvi mʻfU AvKvi AvqZb ešʻZI mjeʻta nte| Zte w`i tRU megvʻbi tPʻtq QʻjU Pj v tRU megvʻb t`LvʻZ cʻPz Z` e`envi KiʻZ nte| ZvB mvariY KivʻúDUvi hZUv teM mʻúbentʻq v`iKvi Zvi PivʻZ gviéngvWqv KivʻúDUvi teik teM mʻúbentʻZ nq, `šʻZI teik jvʻM| `šʻZ kvʻ³ teik _vKʻtj KivʻúDUvi bivv aiʻbi Drm t_ʻK tj Lv, Qve, Pj wʻPĪ, kã Gme tPivʻLi cjʻK c`ʻq Gʻb nviRi KiʻZ cvʻti; GK velq t_ʻK `iKvi gʻZv nviBcviʻij tʻi mivvʻth` Ab` velʻtq Pʻtj thʻZI mjeʻta nq|

gviéngvWqv e`envi w`b w`b we`Z.nʻtʻQ| eZgʻvʻb GKUv eo aiʻbi e`envi nj vKʻʻvi tʻʻtj| weʻkʻl Kʻi wekʻKvʻl RvZvq eBʻZ Gi e`enviʻi mivvʻth` bivv aiʻbi velʻtqi mgvʻvi NUvʻbv hvq| wʻPivKrmwe`v tkLvi Rb` nqʻZv GKUv bKj gvbʻʻi Ici gviéngvWqv mivvʻth` kj`e`etʻQ` NUvʻbv nʻtʻQ; tmLvʻb neykv`we`iv t`LʻZ cvʻtib vKʻfivʻe kixʻiʻi tʻfZʻi weʻfbaʻAsk KvR Kʻi| vKsev Bʻtj KUibʻt` i Ici gviéngvWqv t_ʻK neyʻcʻKšʻkj xiv t`LʻZ cvʻteb Bʻtj KUibʻK mivvʻKʻUvi weʻfbaʻAsk vKʻfivʻe KvR Kʻi|

gviéngvWqv Avl Zv AZ`šíe`vcK| GLvʻtb tU· U, mivDʻB, Qve GvWʻUv, G`vnbʻtʻgkb BZ`w`i mgšʻq Kiv mʻe| G KvʻRi Rb` GWe včʻgqv, GWe AvdUvi Bʻtd±, gvBʻtʻmvdw vj KʻzqW tʻgʻkb, KʻBK UvBq, gvBʻtʻm vj gviWqv R`vʻg Iʻtqevi, v_W v`v v`v g`v· , v`v tʻqUf Iʻtq v`v v`v, Iʻtq v`v v`v, tʻbUʻt`c tʻbivʻfʻMUI, GWe dʻtʻUvkc, Bj v`mʻtʻUvi, tKvʻtj Wʻ tKivqKʻG· tcm, BbivRvBb, tʻcR tʻgKvi, j tʻmʻtʻgʻkb, Gʻtʻgvi v`dʻqʻg cʻf`vZ. mduʻ q`vi , tʻj v e`eüZ nʻtʻQ|

1. Kivʻúv vW`

Avki `kʻKi iʻiʻZ NUj GK hMvšKix D`mʻeb; Gj vmiW (CD) ev Kgc`v± vW` (Compact Disk)- ZvʻZ PivKiv iʻayGKcʻtʻk tiKW`Kiv, GKmʻtʻz WRb `B Mvb tkvʻbv hvq cʻq 80 vjvU Nʻti| Avi Gi aʻvibʻl AvʻtʻMi me vW`-i tʻPʻtq Dbzʻgvʻbi | ZvQov G aiʻbi vW`-i tiKW`evRvvi Rb` vcb e`envi KiʻZ nq bv, vbgʻvʻ³ i mʻ² tʻj Rvi Avʻtʻj vK i vKʻv vW`-i AvZ vjv v LuR t_ʻK kʻtʻai mʻstʻKZ cʻto tʻbq, ZvB hZʻæKʻi e`envi Kiʻtj G vW`-eüv`b tʻUʻK|

Kgc`v± vW`-i mPivPi 12 tmvʻg (4.72 BvĀ) Pʻl ov GKUv wʻfbvʻBj cʻmʻv`-tʻKi PivKiv | Zvi Ici Mʻtʻgʻvʻtʻdv tiKʻtʻWʻP gʻtʻZvB AvZ mʻ² LuR tʻKʻtʻU DʻEzibPz`vʻtʻMi gʻtʻa` Z` mibʻteK Kiv _vʻtʻK| GB cʻmʻv`-tʻKi Ici cʻq tʻg nriev A`ij vjv vqʻtʻgi, Zvi Ici GKUv embʻʻki cʻq c t`qv _vʻtʻK| 1986 mʻtʻj cʻq GKUv wekʻKvʻl (The Academic American Encyclopedia) vmiW-ig-G tʻXivʻtʻbv nq; cʻq Pj wʻPĪ (A Hard Day's Night) vmiW-ig G tiKW`Kiv nq GB gvĪ tmv`b- 1993 mʻj | cʻq cʻq th me vmiW-ig tʻewi tʻqʻQj Zv t_ʻK iʻayZ` cov thZ, vKš`ZvʻZ tʻKvʻb Z` tʻj Lv thZ bv| AvR Avl GUV mZ` bq| AvRKij bZb aiʻbi vmiW-ig tʻewi tʻqʻQ hʻZ Z` eri eri tʻj Lv hvq I cov hvq; ZvʻK ejv nʻtʻQ vmiW-Avi |

umw-ig wBtfi tPq tek tetM| kã, Qie Ges KwúDUvii Z_ mÂq e`e`ri tPqT
GtK ejv nt`Q GK `eciek AMVuz| iaygkKj nj GLbKvi Pjuz umw-ig wBtfi
e`tj Gi Rb` KwúDUvii bZb wwfW wBf e`envi KitZ nq|

wwfWtZ thgb ivLv hvq Mvb, tZgub Pj wPÎ, wfwI tMg Ges Avtiv bivr aitbi eüglx
(gwiëngwqv) kãZtj vKb Abõv| Gi wecy aviY Pgzv AvMvgtZ bivr bZb bZb
aitbi Abõvbi Rbft`te; fivel tZ nqtZv Ggb wfwI cvl qv hvte hvZ iayczi v GKUv
QvqvQie t`Lv hvte Zv bq, tm Qie tZ `kKki cQ`gtZv Kvbvxi mgvB, msjvtci fvlv I
K`vtgivi KvRi fiv½ ubePb Kiv hvte| A_ P` wKQv tbi gta`B wwfW AvRtKi j 0
tc- vqs tiKW, AwI umw, umw-ig I wfwAvi-Gi `vb `Lj Kti tbtel Zte AvR th
me umw wv` AvtQ Zvl envZj ntq hv`Q bv; wwfW wBtfi Kivvgtv Ggbfite `Zwi
ntqtQ th ZvtZ bZb Dbz` chv³ i wwfW wv` thgb Pj te tZgub Pjuz aitbi umw-
igl Pj te|



cvVvEi gj`vqb: 6.10

A) iPbvj-K cãe

1. gwiëngwqv ej tZ wK tevSb?
2. nvBcvi wj ¼ wK?
3. gwiëngwqv e`eüZ tcMv tgi bvg, tj v wK?
4. umw I umw-ig ej tZ wK tevSb?
5. umw I umw-ig Gi gta` cv_ R` wK?

cW 6.11

ukŋv cħyʒ

Dʒik

GB cW tkʒl Avcwb—

- cħyʒ i avi Yv e˘vL˘v KiʒZ cviʒeb;
- ukŋv cħyʒ i A_˘ej ʒZ cviʒeb;
- kēY-˘kθ ukŋvcKiʒYi bvg ej ʒZ cviʒeb;
- cħyʒ i cKviʒf˘ mʒʒU ej ʒZ cviʒeb Ges
- ukŋv cħyʒ i ŋwfbgŋx e˘envi mʒʒúK˘eYθv v ʒZ cviʒeb|

cħyʒ e˘vcviUv fvix gRvi | MvʒQ Dʒv hʒZv Lŋx civKv Avg cvotʒ _vKb, Zvi mʒʒ½ cħyʒ i tKvb mʒʒúK˘ʒbB| ŋKš˘ thB civKv AvgvU ZvK Kʒi ŋKj Qvʒtj b ŋKsev AvKŋk v ʒq AvgvU cvotʒ tMʒj b, Agvb e˘vcviUv cħyʒ i Avl Zvq Gʒm tMj | cvʒq tntU hZ Lŋx ágY KiʒZ _vKb| Zvi mʒʒ½ cħyʒ i tKvb mʒʒúK˘bvB| ŋKš˘ thB Miai Mvotʒ, mvBʒKʒj ev vı· vq Pvcʒj b Agvb e˘vcviUv cħyʒ vbfʒ nʒq tMj | ŋKsev tKvb ˘ŋ evRvKʒi i gʒZv hv GKUv Av˘lgjMx nʒZ atı ˘vZ v ʒq vPvʒtq tLʒq tdtj b, Zvŋtj cħyʒ ʒK Gvotʒ tMʒj b eʒU, ŋKš˘ thB gʒMxUvʒK RevB Kʒi evU v ʒq KʒU bvbv i Kg gkj v v ʒq KovBʒZ Dbʒb Pvcʒtq ivbv Kʒi nvZvq teto ŋcvotʒ ev gv˘ʒi eʒm Lveri cŋvZ vbt˘Qb Agvb cħyʒ i Ketj evav cotj b| cħyʒ Ggb GKvU nvvZqvı hvi mrvvʒh˘ gvby cKvZʒK vbtʒRi i avP I Pvn˘v gZ e˘envi Kʒi vbtʒZ cvʒı | Avi GB cħyʒ ev tUKʒbvj RvB gvbyʒK cŋYx RMʒZi Ab˘vb˘ m˘m˘ t_ʒK c_vK Kʒi tiʒLʒQ| cŋYx RMʒZi gʒa˘ GKgvŰ gvbyB cħyʒ AvqZi KʒiʒQ| thv b t_ʒK gvby cv_i Nʒl Av_b RvjvʒZ ŋKLʒj v tmv b t_ʒKB cħyʒ i hvŰv i iæntjv| AvR chŒıG cħyʒ i AMŋvZ Avi _vʒgvb| Avi tKvbv b _vgʒel bv eis AevK t_ʒK AevKZi ˘ʒı μgvMZ GvMʒq Pj ʒe|

tgŒgvıQi tgŒPvK, eveB cvvLi evmv ŋKsev QʒPvi MZ˘ŋKš˘ cħyʒ bq— G nʒjv mnRvZ cħyʒ ev Instinct, cħyʒY nvRvi eQi AvʒMI I ʒı i ˘ŋZv vQj I BUKzAvRI Zvʒı i ˘ŋZv GKB chʒq, Zvıv bZb ŋKQyʒkʒLvb, tkLvi tKvb ZvM I Abʒe Kʒıvb|

cħyʒ i cħvb ˘enkó˘ nʒjv GUV ŋKvkgŋx Ges Gi ŋKvK NʒU R˘ıgvıZK AbʒvʒZ| cħyʒ i GB ŋKvʒki cħvqıʒZB gvbe mʒ˘Zv eZŋvb ˘ʒı Gʒm DcbvZ nʒqʒQ|

e˘Z PpvŒıvPvʒı cħyʒ MZ ˘ıı ev Dcv˘vʒbi Dci vbfʒ Kʒi Drcv˘b cħvqv, Drcv˘b mʒʒúK˘, mgvR e˘v, mgvR mʒʒúK˘, ms˘vZ, ukŋv, ivRbvZ, cvı Pıj b I ivŏıfc chŒı| gvby AvR cħyʒ i Ggb GK chʒq GʒmʒQ hLb tm tPŏv KiʒQ tmŒı RMʒZi mgv Qvotʒq gnvkʒb˘ cıxŋvMvi ˘vcʒı K_v, fvʒQ Avʒıvı MvZ A_ʒ cŋZ tmʒKʒD 1,86,000 gvBj MvZʒeʒM ARθ Kivi K_v, th MvZʒZ e˘kvʒʒZ i fcvŒıı Z nq (E=mc²)|

AʈbK mgq Avgiv ʈkʈv cʈnyʒʈK Btj KUib. mi Ävgw`i mʈ½ GKvi Kti tdlw | G kZväxʈZ AʈbK NUbv NʈU tMʈQ | Ggb ʈK we`y kwiʒ hwi` wPiZʈi wejʒʈi nʈq hvq Z_wcʈ ʈkʈvʈq cʈnyʒʈi cʈqʈRbxqZv`_vKʈe | ʈkʈvʈi b`vq ʈkʈv cʈnyʒʈi m`j cʈvix | ʈkʈv cʈnyʒʈi ʈkʈvʈµg cwi Kíbv, gj`vqb I cv`vb bevqʈbi mʈ½ weRwZ | ʈkʈvʈYxq weʈq, ʈkʈv`vʈb, Kvʈvʈgv MVʈb Ges cwi Kíbvq ʈkʈv cʈnyʒʈi ev`é cʈKuZi KvʈRwiZv I hʈMvʈthvMzvi cʈyt cʈkʈvʈY mʈzDc`vcbv`áz cwi eZʈkxj mgvʈR e`wʈi Dbqʈb mrvqZv Kti | gvby, hʈj ÄvbywʈzK mi Ävgw`i mgʈʈq MvZ hMcr wµqvKj vtc, cʈmʈ½K ʈkʈvʈ I ʈkʈv cʈvqv DbqʈbKʈi cʈvbZ ʈkʈv cʈnyʒʈi káw D`wZ nʈqʈQ | ʈkʈv cʈnyʒʈi ʈkʈv mspwʈš mgm`vi mʈt_ m`úKʈʈʈ | ʈkʈv ʈqʈʈi Gi `enkö` nʈjv mʈk;LLj cʈvq mRbKxj m`ú` AvniY |

ʈkʈv cʈnyʒʈi A_©

mrvaviY Aʈ_©cʈnyʒʈi ejʈZ Avgiv evʈ ʈKQyʈšcʈwZ, Kw`úDUvi ev`qswµq tKvb e`e`v | Dbz t`ʈki ʈkʈvʈK, ʈkʈv cʈvmK I ʈkʈvʈµg weʈklÁiv cʈnyʒʈiK gʈb KiʈZb ʈkʈvʈi KʈR hʈšj e`envi | ʈKŠ`cʈZcʈʈ cʈnyʒʈi`i ayʈšcʈwZ, Kw`úDUvi ev Riwj tKvb gva`g bq eis Gil cwi Kw`i Z i wZex Kgēšv weʈkl |

Kwgkb Ab BÝUʈKkbij tUKʈbij Rx ʈkʈv cʈnyʒʈiK Gfvʈe msÁvqZ KtiʈQb ʈkʈv cʈnyʒʈi nj thvMʈthvM wecē t`ʈK D`wZ tmB wgvWqv hv ʈkʈvʈK, cv`eB I Ab`vb` ʈkʈi mvgMʈi cikvcwʈ ʈkʈv`vb KvʈR e`eüZ nq |

ʈkʈv cʈnyʒʈi `ʈ fivM wefʈ- nvwʈq`vi I mdUʈ q`vi | ʈkʈv`vb Kvʈe`e`üZ hšcʈwZ, `e`yZK mi Ävg I ʈkʈv DcKiY G_ʈj nj nvwʈq`vi | thgb- tiwvi, wUwf, PjwPĪ, tUcʈiKWʈ, cʈR±i, gyʈhšj PKʈevW`BZ`w` | tKvb weʈqʈi Kvʈʈg cwi Kíbv, cv Dc`vcbv, cv` weʈqe`; Awvi Ges wfwvi ʈZ aviYKZ.weʈqe`; `wBʈw aviYKZ.Qwe, Kw`ʈR AswKZ Qwe I wPĪ G_ʈjv mdUʈ q`vi | ʈkʈvʈKi cvimZv, ʈkʈv`vʈbi cʈz`wʈfʈ½ I AbʈwZ G_ʈjvʈKl mdUʈ q`vi ejv nq |

Ávb weÁvʈbi wewfækvLvq e`vcK MʈelYvi`iaʈ eZʈvb kZväxi wDZxq fivM cv`µg `áz cwi ewZ` nʈq weʈqe`i Kʈjei teto tMʈQ | KvʈRB GB cwi ewZ` cwi w`wZʈZ MZvbmZK avivq cv`vb Ae`vnZ`_vKʈj ʈkʈv`w cʈqʈ GB mwxgZ mgʈq MʈelYvj ä D`Pzi ʈkʈv MʈY m`e bq | cixʈv wbxʈv Kti t`Lv tMʈQ th, mʈzcv`vb AʈbKUv wbfʈ Kti ʈkʈv`vb cʈnyʒʈi Dci | A`eÁvmbK ʈkʈv c`wZ AbʈviY Kiʈj ʈkʈv`vʈbi Dʈi`k` e`_qʈq hvq |

ʈkʈv`w Bw`ʈqʈi mʈ`envi Kti dj cʈn-ʈkʈv`vʈb Ges ʈkʈvʈq tcl Yv mʈw KiʈZ nʈj ʈkʈv cʈnyʒʈi Dcv`vb kēY-`kʈ ʈkʈvʈvKʈiʈyi gva`ʈg bZb ʈkʈv`vb Kgʈwʈ MʈY KiʈZ nʈe | `vfwēK fvʈe ʈkʈv`vʈb cʈvbZ kēY-`kʈ Bw`ʈqʈi gva`ʈg ʈkʈv`w gʈb AbʈwZ mʈw Kiv nq | KviY G`w Bw`ʈqʈi mrvvʈh` 85 fivM ÁvbrB m`e | cvövtZ`i ʈkʈv cʈZövtb Kw`úDUvi mʈthvM Kti bZb AvwʈzK ʈkʈv`vb cūv Pvj yntqʈQ; ʈKŠ`ZZxq weʈk; kēY-`kʈ ʈkʈvʈvKʈiʈyi gva`ʈg ʈkʈv`vb cʈjvcvj m`e nqib | eZʈvʈb AvawbK ʈkʈv weÁvb

ḡ Ae GwKkb

ḡv v Kivhēy-`kḡ ḡvKiy e'enḡi Dci meḡK , iaz; Avivc Ktiḡ Ges
ḡv Di - LthvM Dbḡb j ḡ Kiv hvq Gi ḡgveKivk |

kēy-`kḡ ḡvKiy th tKv melḡ ḡó aviYv MVḡb mivh Kti | tKv melḡ ḡó
aviYv MVḡb mivmwi AwfÁZvB mēfKó. thgb GKU Avg ZLbB Avgiv ḡḡḡḡDcj wä
Kwi hLb Avgiv GKU mivZ Avg t`L, ḡkKwi, MÜ tbB I ḡ MḡY Kwi | GB weivU
RiUj wēkḡi meḡQyGfite mivmwi AwfÁZvi gvaḡḡ Dcj wä Kti tKlv hvq bv | AḡBK
cwi ḡZḡ meKí tKv ḡQy mivh ḡbZ nq | kēy-`kḡ ḡvKiy Gme meKí i
tRvMv ḡ ḡQ |

kēy-`kḡ ḡvKiy ḡvK Aḡḡv ḡvḡK mivh Kti- ḡv v Aḡḡv ḡv
MḡY mivqZv Kti | ḡS' Gi Aḡḡ bq th kēy-`kḡ DcKiy ḡvK cwi kḡ Kwḡḡ
t`q | DcKiy Qvov ḡv v Aḡḡv DcKiy Gi mivh ḡv v KivhḡKRB ḡvKḡK
AḡBK tek cwi Kíbv I cḡḡZ ḡbZ nq Ges Zvi GB AvZwi³ cḡPóvq ḡZvb ḡvḡ
Aḡḡḡv MḡY meḡv cḡḡZ.nb |

AvavK kēy-`kḡ ḡvKiy ḡZb aiḡbi-

- kēy
- `kḡ I
- kēy-`kḡ |

kēy- th mKj hḡšj mivh tKvb hvq ev iḡb Ávb jvf Kiv hvq ZvḡK kēyḡj-K
DcKiy ejv nq | thgb- tiWvI, tUcḡiKWḡ, Aḡḡḡḡḡv |
`kḡ- th mKj hḡšj ev DcKiy mivh tKej t`L hvq ev t`ḡL Ávb jvf Kiv hvq
ZvḡK `kḡj-K DcKiy ejv nq |

`kḡj-K DcKiy ḡ cKivii | (K) cḡRḡW I (2) bb-cḡRḡW |

(K) cḡRḡW: th me e' t`Lvi Rb cḡRḡ cḡqvRb nq, thgb-
ḡdj ḡó cḡRḡ, ḡBW cḡRḡ, Gicḡḡv ev IḡcK
cḡRḡ, I fviḡnW cḡRḡ, ḡvBḡḡḡv BZḡḡ |

(L) bb-cḡRḡW: th me e' t`Lvi Rb cḡRḡ cḡqvRb nq bv | thgb-
PKḡW, dḡḡḡḡḡ, Mḡd, cwióK tevW, ḡvMḡbW
tevW, ḡceB, ḡceB, dḡvK KivW, t`qvj Piv, ḡvḡPḡ,
ḡWj, QweḡZ Mí BZḡḡ |

kēy-`kḡ- th me hḡšj gvaḡḡ t`L I tKvb hvq ev t`ḡL I iḡb Ávb jvf Kiv hvq
ZvḡK kēy-`kḡj-K ḡvKiy ejv nq | kēy-`kḡj-K DcKiy ḡ cKivii |

(K) cʰRʹ±W: Pj wʹPĪ, mevK wdj ʹóč |

(L) bb-cʰRʹ±W: tUwj wʹfkb, cʹžž bvP, cʰkʹx, bvUK, wewPĪ vbʹv, wēZKʹfʹv, wʹqʹv-āgY, KʹwʹúDUvi, gwēwqʹwqʹv BZ`wʹ |

G mKj DcKiY th iayKihʹqʹZv ewx Kʹi Zv bq, G, wj wʹqʹv_ʹ ʹfʹmeK tKŠZəj DĪxcʹb GK HʹRwʹj K cʹfve wē`i Kʹi | G mKj DcKiY e`enitʹi cʹvbxq wēl qe`tK GKwʹtK thgb mRʹe, gZʹI AvKIʹxq Kʹi tZijv mʹe KviY G, tʹjv ZvʹqʹwʹK fʹtʹe wʹqʹv_ʹ ggʹtʹj Mfʹxi `wM KvʹU, Ab`wʹ tK tZgb ʹfʹmeK Pwʹn `v Pwʹi Zvʹ_ʹP dtʹj wʹqʹv_ʹ AvPvi AvPiʹtʹy ewwʹAZ cʹwʹeZʹB mʹwʹAZ nqʹ | mʹwʹgZ Aʹ_ʹP Rb` Avqʹv`i wē`ij q, tʹjvʹZ cʰqʹvRbxq DcKiʹtʹyi Afʹve itʹqʹtʹQ | wʹKŠ` wʹqʹK-wʹqʹv_ʹ mʹwʹsʹj Z cʰPóvq ʹvbxqʹfʹtʹe t`kxq mʹwʹú` wʹtʹq AʹbK wʹqʹvʹcʹKiY `Zwi Kiv thʹZ cʹtʹi |

wʹqʹv cʰnyʹ i e`envi

wē`ij tʹqi wʹbgʹkʹwʹ t_ʹtK iiaKʹi mekʹe`ij tʹqi D`P tʹkʹwʹ chʹš meʹ cʹvʹtK mnRʹeva` Kʹi tZijvi Rb` bʹvʹv DcKiY `Zwi Kiv nʹ`Q | G, tʹjvi cʰZKiʹtʹy Mʹto DVʹtʹQ KviLvʹv | G, tʹjvi DbwʹZ I beZi D`mʹtʹbi Dʹiʹtʹk` PjʹtʹQ wʹbišʹi Mʹtʹel Yv | cʹwʹ_ex mʹwʹi gZ j qʹtʹKwʹU eQʹi i cʹjʹvʹv NUbʹvʹtʹK thgb Kʹvʹtʹgivi mʹwʹvʹtʹh` tʹkʹwʹKʹtʹqʹ wʹPĪwʹqʹZ Kʹi cʰRʹ±tʹi i mʹwʹvʹtʹh` t`Lvʹtʹv mʹe nʹ`Q, tZgʹwʹ qʹžʹwʹZ qʹžʹʹAYyci gʹvYj MʹwʹZwʹeal t`Lvʹtʹv hvʹtʹQ | wʹqʹv cʰnyʹ i wewʹfbʹeDcʹv`vb iaycʹw Dc`vʹcʹtʹbi tʹqʹtʹĪB bq cʰqʹwʹM nʹ`Q wēl qe` `Zwi i tʹqʹtʹĪ, wʹqʹv_ʹwʹg Dbqʹtʹbi Mʹtʹel Yvi tʹqʹtʹĪ, cʹv`vb cʹwʹZi Dbqʹtʹbi tʹqʹtʹĪ, cʹv`vb I wʹqʹv_ʹ AvRʹZ Ávʹtʹbi gj`vqʹtʹbi tʹqʹtʹĪ, wē`ij q cʹwʹi Pjʹv bv I tiKWʹmsi qʹtʹyi tʹqʹtʹĪ | mʹzʹivʹs ejv hvʹq eZʹgʹvʹtʹb wʹqʹvi mʹwʹeR e`e`vʹcʹv I cʹwʹi Kʹi bʹvi tʹqʹtʹĪ wʹqʹv cʰnyʹ i cʰqʹwʹM e`vʹcʹK I KivʹRʹi |



cʹvʹtʹwēi gj`vqʹb - 6.11

iPbʹvʹj-K cʹkʹe

1. cʰnyʹ wʹK?
2. wʹqʹv cʰnyʹ ej tʹZ wʹK tʹvʹtʹSb?
3. wʹqʹv cʰnyʹ nʹwʹPqʹvi I mdʹUʹl qʹvi ej tʹZ wʹK tʹvʹtʹSb?
4. wʹqʹvi tʹKvʹb tʹKvʹb tʹqʹtʹĪ wʹqʹv cʰnyʹ cʰqʹwʹM Kiv nʹ`Q?
5. kʹeY-`kʹ wʹqʹv DcKiY wʹK?
6. wʹqʹv DcKiʹtʹyi cʰqʹvRbxqZv e`vL`v Kiʹab |

hZ,tjv t`uUmkU tcUvng evRvti PvjyitqQ tm,tjvi gta` Avgt`i t`fk metPtq RbucQ I euj cPij Z t`uUmkU nt`Q tjvUvm I qvb-Uz_x| GB t`uUmkU tcUMUgiUi Wm, DBbtWvR Ges g`vKbUK wZbuU ms`iYB cvlqv hvq| GB t`uUmkUUi mnvth` thvM, we tqM, _Y, fivM, MEd I Ab`vb` MvYwZK KvhEjx AZ`S`mnR I my`i fivte Kiv hvq| thgb-

- cwi ewi K evtRU `Zvi |
- tKvb cUzOv`bi mvari Y nmve vbKv`ki KivR|
- teZtbi nmve (Pay Roll)|
- BbtFvU^a(Inventory)|
- evtRU I webtqM wekQ Y|
- t`vKv`b tμZvi vej cUq|
- we`ij tqi cixv`vi djvdj `Zvi |

Dctiv³ KvhEjx QvovI t`uUmkUUi gva`tg Avil A`bK iKg KvhEjx m`uv`b Kiv hvq| thgb-

vbr`E tKvb titAi Dci hLb digjv cUqM Kiv nq ZLb t`uUmkU vbr t`_tKB cUqMKZ. digjv Ablyqx thvM, we tqM, _Y, fivM Kti vbfj djvdj Dc`vcb Kti |

A`bK mgq GbuU^a Kiv tWUv cwi eZB, mstkrab ev g`Q tdjvi cUqRb nq| tm t`q`i th tKvb cwi eZB mvaZ trvK bv tKb t`uUmkU `qsv`qfivteB cwi eZ`Z djvdj Dc`vcb Kti |

A`bK mgq IqvK`U G Kjvg ev mvi BbmU^ev vWij U KitZ nq| tm t`q`i tWUv Kuc ev g`f Kti tWUv`K GK`vb t`_tK Ab`v`vb `vbr`S`i Kiv m`e nq|

tU· U, fiv yev digjv`K IqvK`UUi GK`vb t`_tK Ab`v`vb mn`RB Kuc Kiv hvq| thgb GKwU cUzOv`bi 100 Rb KgPvixi cUz`tKi tgvU teZb (g- teZb, evno fivov, vPvKrmv fivZv, hvZvqvZ BZ`v) djg`jvi mnvth` tei Kiv hvq| G t`q`i tgvU teZb KjvgvU tKejgvI cUg e`v`i t`q`i digjvU cUqM Kti D³ digjvU evKx mvi mg`n Kuc Kitj B mivK djvdj cvlqv hvte|

IqvK`UUi gta` hiv` vKQy tWUv g`Q hvq ev g`f Kiv nq A`ev Kuc Kiv nq Zvntj D³ tWUv ce`e`v`q vchv`tq Avbv hvq|

IqvK`UUi tWUv`K wevfb`Format G wev`v`i Kiv hvq| thgb- tWUvi gta` UvKv (\$), Wjvi (\$), cvDB (£) BZ`v` vPy h`v` Kiv, kZKiv (%) vPy h`v` Kiv, `kvgtKi cieZ^e msL`v vba`Y Kiv, ZviiL cwi eZB Kiv BZ`v` KvR,tjv mPv`i`a`f`c m`uv`b Kiv hvq| G Qvov HvU`K Wv`b, evtg, tKb`v`mvi`tq mvrvtbv hvq|

փ Ae GW#Kkb

c0qvr#b c#jv I qvK#UuU#K Kuc K#i c#yivq e"envi#cvthvMx K#i tZijv hvq| thgb-
tKvb c0Z0#b i eo AvKv#i i GKuU KvR GKuU dvB#j msi#Y Kiv nj | GLb Ab" GKuU
KvR cvI qv tMj hv D³ KvR#U i gZB, mvgvb" #KQMy cwi eZ# i#q#Q| tm t#j#T D³
dvBj u#Z KvR K#i Zv wfb#b#tg save Ki#j B I qvK#Umn D³ dvBj u# bZ# Av#i KuU
I qvK#U cwi YZ n#e|

Z_#mgn# uc0U Kiv qvq, Z_#mgn#K Bold, Underline, Italic, Shading BZ#w` Kiv
hvq|

Dc#iv³ Kv#e#j x QvovI t`u0#kU Gi gva#tg Avi I b#vvi Kg Kv#e#j x m#uv` b Kiv hvq|
me ai#bi tKvqvb#UuUf G#vbj vBimm w#uEK g#Wj `Zwi i Rb" t`u0#kU GKuU e#j
e"e#Z c#u#Z| t`u0#kU e"env#i i L#y m#vaviY t#j#T #jv n#Q c0R# K#v#s G#D
B#f#j #qkb, c0R# tc0dvBj `Zwi Kiv, ti#kI G#vbj vBimm, tmb#m#Uw#uU G#bj vBimm,
th tKvb ai#bi tKvqvb#UuUf g#Wj Kiv| t`u0#kU Zwi g#W#j th tKvb ai#bi m#tkvab,
cwi eZ# m#t#RB Kiv hvq|

PvU#W#GKvD#U#U, wdbv#kq#j G#v#v#j #, Kbm#j #U#U, Bw#v#qvi c#f#Z. tckvR#me hviv
msL#v w#t#q KvR K#i b Z#` i t#j#T t`u0#k#U i tKvb w#K#i t#B|

t`u0#kU w#kvj AvKv#i i GKuU I qvK#U| I qvK#U n#Q KZK_#jv m#vi I K#j v#gi
GKuU e#K| GKuU I qvK#U i m#vi msL#v 1 t_#K 8192 u# Ges K#j v#g msL#v 256 u#|
m#vi #j v#K msL#v w#t#q Avi K#j v#g #j v#K A#j i w#t#q w#P#y#Z Kiv n#q#Q| c0g 26 K#j v#g
0A0 t_#K 0Z0 A#j i w#t#q w#P#y#Z Kiv n#q#Q| cieZ# 26 K#j v#g 0AA0 t_#K 0AZ0
A#j i g#j v w#t#q w#P#y#Z Kiv n#q#Q| Zvi cieZ# 26 K#j v#g 0BA0 t_#K 0BZ0 e#y#j v w#t#q
w#P#y#Z Kiv n#q#Q| G f#v#e t#kI K#j v#g b#v t#0#v ch#s#e#y#j v w#t#q w#P#y#Z Kiv n#q#Q|

m#vi #j vi c0#xK I qvK#U i evg c0#s#Dci t_#K w#P eivei t`L#Z cv#eb| K#j v#g #j vi
c0#xK I qvK#U i Dc#i f#v#M c0Z#U K#j v#gi w#k#i v#v#tg t`L#Z cv#eb| m#vi I K#j v#g
ci`ui th `v#b tQ` K#i tm `v#b GKuU ev. `Zwi K#i | GB ev. #K ev tQ` `v#b#K t#j
(Cell) et#j | t#t#j i c0#xK t`#L t#t#j i Ae`vb m#v#³ Ki#Z cv#eb| K#j v#gi c0#xK I
m#vi i c0#xK GK#T w#j#j Z n#q t#t#j i c0#xK m#v# K#i |

I qvK#U i c0g t#t#j i c0#xK n#Q A1, A n#Q K#j v#gi b#v Ges 1 (One) n#Q m#vi i
b#v| t#j #j v#Z w#v#b#e#i#bi Z_# w#j #L Zv msi#Y Kiv hvq| t`u0#k#U Z_# #K w#b#Ri
gZ K#i m#v#R#q t#b#q hvq Ges Z_# #j v#K M#v#u#ZK cwi MY#v#q e"envi Kiv hvq|
t`u0#k#U i m#v#v#h" Av#iv A#b#K ai#bi KvR Ki#Z cwi; thgb ev#RU `Zwi, em#R
c0Z#e`b `Zwi, Drcv`b e#e`vcbv, me ai#bi cwi msL#vb, BZ#w` | M#v#d#` i m#v#v#h"
t`u0#k#U i Z_# t_#K XY, BAR, LINE, STACKBAR Ges PIE BZ#w` #j L#P#T `Zwi
Ki#Z cwi | GKuU t#W#v#e#mi m#v#v#h" th me KvR Kiv m#e Zvi c0q me #j v KvR
t`u0#k#U i m#v#v#h" Kiv hvq| thgb- m#u#s# ev m#v#v#b, m#v#p#s# ev A#v#y#U#v, t#g#u#s# , w#t#M#k#b,
w#t#k#d#Y BZ#w` | GuU G#b GKuU m#g#v#Z t#0#M#g hviv m#v#v#h" t#Q#U#L#U e"emvi me ai#bi
KvR Kiv hvq|

D`niY:

nvWwV` t`_tK wKfite tj vUvm tcMAtg cOk Kiteb?

1/ KivúDUvtii cvl qvi mBP Ab Kti wKQY AtcTlv Kitj c`q wbtPi tj LwU t`Ltz cıteb:

C:\>

2/ cd Lotus UvBc Kti GvUvi PvcTj wbtPi tj LwU t`Ltz cıteb:

C:\LOTUS>

3/ cıvıq Lotus UvBc Kti GvUvi tPtc wKQY AtcTlv Kitj c`q tj vUvm A`vKtmm wmt÷g tgbw t`Ltz cıteb/

1-2-3 Printgraph Translate Install View Exit
Enter 1-2-3 Lotus Worksheet

1-2-3 Access System
Lotus Development Corporation
All Right Reserved

Gme evZt gta` c`t Dctii Astk cOkwZ 6wU evZtK tgyetj | KvtRi mgq GB 6wU tgyj thwU cOkvRb tmUtk tetQ wbtZ cvıteb/ G Ae`ıq 1-2-3 tj LwU wı fvm`ıstq cıteb A`t tmj ctqbtUi 1-2-3 tj LwUı Dci cıteb A`t 1-2-3 evQvB Ae`ıq cıteb/ Gevi GvUvi PvcTj wKQY ci A`vKtmm tgbw gtQ wmtq c`q 8 Kj vq Ges 20 mwi wekó GKwU IqvKkU tftm DVte/

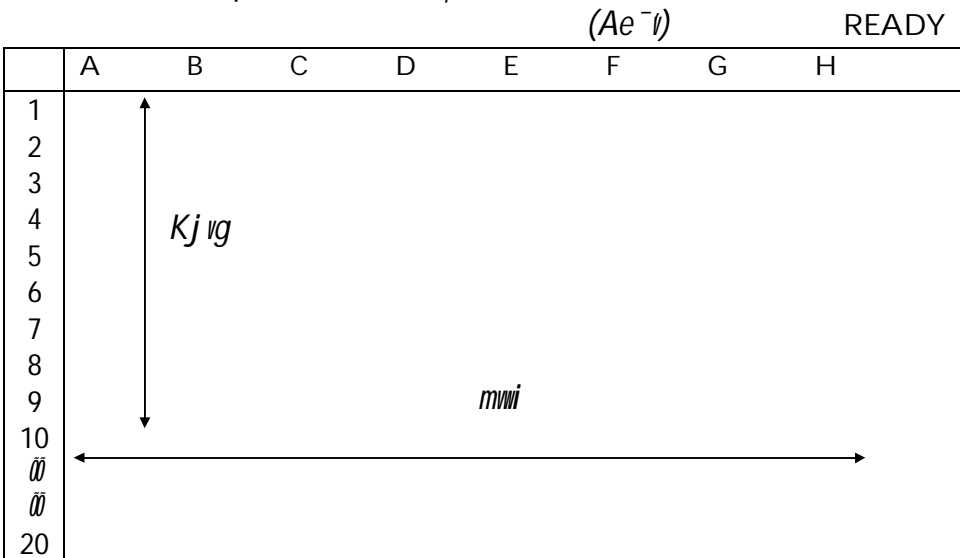

Āē Ae ĠWĶKkb

GLb G Ae Āē I qvKĀU th tKvb Z_ Kjvg űĶtĭvbg, MmYwZK mĀ BZ Āē MĀY Kivi Rb cĀZ _vKte| GKĭU dĭKv I qvKĀtUi ōGŌ Kjvg I 1 bĀt mwi i tQ Āē vĶK A1 tmj ejv nq| I qvKĀtUi Dcĭi evg tKvĀY tmĭj i űKĭbv Ges tmB tmĭj tKvb tWUv _vKĭj Zv t Āē Lv hvte| I qvKĀtUi Dcĭi Wvb tKvYvq eZĠvb KvĀRi Ae Āē ev tgvW t Āē LĭZ cvĭeb| H Āē vĶb ti űW K_ űU tj Lv _vKvi gvĶb nj tj vUvm 1-2-3 GLb th tKvb KvR Kivi Rb cĀZ AvĶQ| GK K_vq GĶKB Avgiv emj ti űW tgvW| AĶi tj Lvi mgq ōtj ĩej Ō, msLĭv tj Lvi mgq ōfĭj yĶgbŷ űbtq KvR Kivi mgq ōĶgbŷ Ges fĶ msĶvĶbi mgq ōĠWUŌ K_ űU H Āē vĶb t Āē LĭZ cvĭeb| tj Lvi mgq fĶ Kĭj 1-2-3 exc kĀ Kĭte| c Āē Dcĭi Wvb tKvĀY ERROR K_ űU űGU űGU Kĭte| ōti űW tgvWŌ űdĭi Avmvi Rb ESC Kx PvcĶZ nĶe|

t Āē űWĶU GKĭU tgybyPwĭj Z cĀĶKR tĀŌMĠg| tgybyĀēni Kĭi mnĶR űnmve, tWUv e Āē vĶbv, MŌd cĀĶqKĭY Ges MmYwZK űĶĶ- IĶYi KvR Kiv mĀē|

Ōti űWŌ Ae Āē vq Slash Āē vĶ Kx tPĶc tgyby gj- KgvĶĬ thĶZ nq| G Ae Āē vq Ōti űWŌ K_ űUi Āē Ķ ōĶgbŷ K_ űU I qvKĀtUi Dcĭi Wvb tKvĀY nmĶRi nĶe| G KgvĶĬ, Ķj vi Avevi KZK, Ķj v mve-KgvĶĬ _vKĶZ cvĶi |

D Āē niY t Ōti űWŌ tgvĶW Āē vĶ Kx PvcĶj c Āē vĶ űbtPi tgyby tĶĶm DVĶe| I qvKĀtUi Dcĭi Wvb tKvĀY Ōti űWŌ tj Lvi űi cwi eĶZ ōĶgbŷ tj Lvi t Āē LĭZ cvĭeb| I qvKĀtUi Dcĭi evĶtKvĀY tmĭj i űKĭbvq A1 tj Lvi t Āē LĭZ cvĭeb| tgyby th tKvb GKĭUĶZ cĶqUvi tiĶL Gűvi PvcĶj H KgvĶĬi mve-tgybyZ hvĶ qv hvq|

A1	Worksheet	Range	Copy	Move	File	Print	Graph	Data	System	Quit
	Global	Insert	Delete	Column	Erase	Titles	Window	Status	Page	
	A	B	C	D	E	F	G	H	I	J
1										
2										
3										
4										
5										
6										

GB tgybyĶj vi th tKvb tgybyZ cĀēk KĭĶZ nĶj, H tgyby cĀēg AĶi UvBc KĭĶZ nĶe A_ ev th tgyby cĀēqvRb tmĶUĶK GB ← → Kx, Ķj vĶK tPĶc űmĶj ± KĭĶZ nĶe| tmj cĶqUvi nĶQ űi fĶmĀiĶĶi cĶqUvi | űi fĶmĀiĶĶi tmj cĶqUvi th tgybyĶi Dcĭi _vKte tm tgybyĶK űmĶj ± eĶj Āē Ķi űbtZ nĶe| tmj cĶqUvi WĶb evĶq Dcĭi űbtP mwiĶq tgyby th tKvbUĶK űmĶj ± KĭĶZ cvĶeb| i iĶZ I qvKĀU mve-tgybyĶK űmĶj ± Ae Āē vq cvĶeb| G Ae Āē vq Gűvi PvcĶj 9űU dĶskb t Āē LĭZ cvĶeb| dĶskb, Ķj v nĶj v:

Global Insert Delete Column Erase Titles Window Status Page

I qvKřKU mveřgbyřZ tiÄ mveřgbřZ cřek KiřZ řtj řmj cřqUvi I qvKřKU mveřgby
ř_řK tiÄ mveřgbřZ řmřřq řbřř tiÄ mveřgbřř řmřřř ± řřq řřře| G Ae`řq GřUvi
Přřřř A_er tiÄ křři cř_g eYřAviřPřřř řbřřPi řgbřř ř`Lřř cřřeb|

Format Label Erase Name Justify Project Unprotect Input Value Transpose

Gřřře Ab`řb` řgbřř cřek KiřZ cřřřeb|

řKřře řcřřř cřřřZ`řř Kiřeb?

řcřřř cřřřZ`řř KiřZ řtj řbřřPi Křřřř_řřř řUřBc Kiřb Ges GřUvi Přřřř|

/QY (slash quit, yes)



cřřřřři řř`řqb: 6.12

A) řPřřřř-K cřře

1. I qvKřKU řK? Avřř řPřř Kiřb|
2. I qvKřřřUi cřřřřřřřřř e`řL`ř Kiřb|
3. řmj řK? řmřř ř řKřřv řKřře ř`qř řq?
4. I qvKřKU e`enřři ř řřř_řřř Avřř řPřř Kiřb|
5. ř`řřřřřř řgbřřř řZ řK řevřřb?
6. I qvKřřřUi řřřř Ae`řř ř_řK řgbřř řKřře řřřř řq?

cW 6.13

Z_ cħny̆

Dŋik

GB cW tkŋI Avcib—

- Z_ cħny̆ ĕvL̆v KiŋZ cviŋeb;
- Z_ cħny̆i ˆenkŏ ĕvL̆v KiŋZ cviŋeb;
- Z_ cħny̆i weifbæDcv̆vb I mdUI q̆v̆ti i bvg ej ŋZ cviŋeb Ges
- Z_ cħny̆i µgweeZᄃ weŋkŋY KiŋZ cviŋeb|

eZᄃvb hM Z_ cħny̆i hM| mvaviYfivte Z_ cħny̆ ej ŋZ Z_ msi ŋŋY, cħµqvKiY Ges GŋK weZiY I ĕenvi Kivi cħny̆ŋK eSvq| GŋK Bbdiŋgkb tUKŋbijwR (Information Technology- IT) ev AvBiU bŋŋ AwfwnZ Kiv nq| tUvj thvMŋthvM, DcMᄃ thvMŋthvM, AwVI wfiwVI mæúŋvi, tWUvtem ĕĕvcbv, mdUI q̆vi Dbq̆b, tbUI qvKs, cħKwZK mæú̆ Dbq̆ŋbi Rb̆ DcvĒ cħq̆M, gŋY I wiŋcM̆ndK cħny̆, weŋbv̆b cħny̆, wkŋY-cħkŋY ĕĕv, Z_ fiŋvi cħny̆ me_ŋjvŋK wgvj ŋq Z_ cħny̆ ejv thŋZ cviŋ| Zŋe KivúDUvi cħny̆ ĕeniv̆ti gvaŋgB Z_ cħny̆i ĕcKZv jvf KŋiŋQ| miwKfiŋte ej ŋZ tMŋj KivúDUvi Ges tUvj thvMŋthvM ĕĕvi gvaŋg hveZiq Z_ msMᄃ, GKĪKiY, msi ŋŋY, cħµqvKiY Ges wevbq̆ ĕĕvŋK Z_ cħny̆ wŋtmte wPivŋZ Kiv nq|

wWvRUvj cæwZ D̆wteŋbi dŋj cħny̆mga GKwĪZ nŋq GKwU wekvj Z_ cħny̆ wkŋŋ cwiYZ nŋZ Pŋj ŋQ| Z_ cħny̆i wZb̆w wefivM iŋŋŋQ|

- **Uvgᄃj**: tUvj ŋd̆vb, d̆v̆, KivúDUvi, wfiwAvi BZ̆w̆ |
- **eivK ev K̆wiqvi**: AcwJK̆vj d̆vBevi, KwĪg DcMᄃ, gvBŋµvl ŋqF|
- **mdUI q̆vi**: AwVI, wfiwVI, tŬ U Ges M̆nd̆ |

Z_ cħny̆ kãw Avgvŋ̆i t̆ŋK KivúDUviqbŋK tevSivZ ĕenvi Kiv nq| hŋivtŏ KivúDUviBŋRkb (Computerization) kãw teivk ĕenvi Kiv nq|

Z_ cħny̆i ˆenkŏ

- mgtqi mŋŋ_ GKB cwi gvY KvŋRi Rb̆ µgvŋŋŋq LiP KgŋZ_vŋK|
- mgtqi mŋŋ_ cZ̆w̆kZ KvŋRi cwi gvY µgvŋŋŋq tetŏ hvq|
- w̆wᄃZ ĕenvi mnRZi Kiv mæ̆ nŋŋQ|
- tKivb cħµqv Aŋ w̆ŋB APj nŋq cŋŋ|
- ˆæZ cwi eZŋbi dŋj ĕenvi Kvix I cY̆ Drcv̆ŋKi gŋă mgŋŋŋq Afiv nq|

- uk`Y I msukó KgRvtÜi MvZ`æZZi Kti |
- AcPq Kgvq |
- e`emv emYtR` j vFRbK cµqv mjo Kti |
- GvU GKvU j vFRbK cñy³ thLvfb Kg Bbcy w` tq tekx AvDUcy cvl qv hite |
- DbæZ cñy³ tj bt`b I Z_` thvMvthvM`æZ cwi eZB mvab Kti |
- eZgub mgfq Z_` cñy³ wKfvte mrvh` KiþZ cvti |

eZgub RMþZ Z_`B meþPfq gj`evb mæú` | GKvU cñZovþbi DbæZ, mÜvšf MhY, evBþii cwi eZBkvj RMþZi mvt_ tKvb cñZovþbi thvMvthvM`vcb BZ`w` velþq Z_` AvZ , iæZcY`fvgKv cvj b Kti |

- KivúDUvi nj Z_` cñy³ i mæytk`q Zþ`i mivK e`e`vcbvq GKvU Rvzi AvZ`K i fcti Lv cvtë thþZ cvti |
- KivúLZ DbæZi Rb` Z_` veÁvb , iæZcY`fvgKv cvj b KiþZ cvti | thgb evsj vt`þk tjvK tekx, Rvq Kg | Zþ`i mivK cñqvþM Kul.Drcv`b evx Ges Rvgi`q e`envi Kiv mæe |

gvbemf`Zvi µgveKvþki mvt_ mó Pvv`v mgvþR cfvte tdþj | DbæZZi Rvæb aviY Ges Rvæþbi gvb Dbæþbi Rb` mgvþR AmsL` cY` Ges tmevi mjo nt`Q | e`e`vcbv I cñy³ gvþþK cY` ev tmev MhþY`q Kti ZþþZ cvti | mgvþR b`vqvþvi cñZov Ges mæúþ` i mlyg evþþbi e`vcti Z_` cñy³ , iæZcY`fvgKv cvj b KiþZ cvti | Z_`vejx Rvþv _vKþj B mgvþRi cñZ AsMvKvi mivKfvte cvj b Kiv mæeci nte | cñy³ I Drcv`b e`e`vcbvq Z_` GLb , iæZcY`fvgKv cvj b KiþQ |

weþk! cþvi gva`g, tUvj thvMvthvM Ges AvšR`K I AvÁvj K ms`vmgæ ci`úþi i Dci wµqvkvj (Interactive) nevi dtþ AvR Avgi v weþk! b v mvi K |

cñMvZnvmK hþM gvbe mf`Zvi AMvZ vQj Lq gšf | ZLb gvþy cñKvZK`þhM I wmsm`eb`Ršf Kej t_þK AvZþi qv Ges cñKvZ t_þK RvæKv mslMni Rb` GZ e`v` _vKþZv th ejþZ tþþj Zv`i tKvb Aemi wQþjv bv | `k nvRvi eQi cþe`hLb Kul. weþtei mPbv nq ZLb gvþþi chþß Lv` I Aemi tRvþU | gvþy wþšfvþv i iæ Kti hšcþwZ e`envi Kti wKfvte cY` I tmevþK Avþiv fiv fvte KvþR j vMvþv hvq | dj kñZ wntþte`þk v eQi AvþM i iæ nq wki weþe | gvþþi gw`þ I mgvR e`e`vi µgk AMvZ ntþZ _vþK |

KivúDUvi GLb gvþþi gw`þk w³ mej KiþQ Ges Z_` veÁvþbi weþe Nvþ`Q | e`e`vcbv c×vZ Ges miKvþi ckvmmvK c×vZþZ KivúDUvi e`vKfvte mrvqZv KiþZ cvti | dtþ Rvæþbi gvb Dbæþ mæe | KivúDUvi kv³ kvjx Ges`ecwæK e`e`vcbv

GBPıUGgGj GBPıUıUıı, wřıWı tUıj řdıv, řj vKıj Gıı qv tbUI qvK,© I qvBW Gıı qv
tbUI qvK,© evBřtbU, KřvřřtbU, I řqeKřg, wřAvı GgGj mn Avřıv AmsL` cřıyř weKııZ
nřřřQ Ges cřZııbqZB nřřQ|



cřřVřři gřřıqb: 6.13

A) iPbıgř-K cřřæ

1. Z` cřıyř ıK?
2. Z` cřıyř i `enıó` ıK ıK?
3. Z` cřıyř i cřřve ıbřř Avřj vPbv Kıab|
4. Z` cřıyř i e`enıřı i KřřKıU řřřřı i bvg Dřjı Kıab|
5. Dcřř řcřY cřřıı qv e`ıL`v Kıab|
6. Dcřř řcřřYi Rb` e`eüZ řřıMřřıM gıı`g, řj vı bvg ıj Lř|
7. KııDııřKkb mđUI qřı eř řZ ıK řeřřSb?

cW 6.14

tWUfem

Df'ik

GB cW tkfI Avcb—

- KwúDUvfi fvlvq tWUv I Z_ eYv KiZ cviFeb;
- tWUv cUqvKiY c×wZ wekY KiZ cviFeb;
- tWUvtefmi msAv w`Z cviFeb;
- wdi , tiKWQ dvBj e`vL`v KiZ cviFeb;
- tWUvtem dvBtj Z_ c`ek, gqZ I msiY KiZ cviFeb;
- tiKWQmsfkvab KiZ cviFeb Ges
- Kzqwi j`vs, tqfR mij BstiwR fvlvq ckwKti Z_ AvniY KiZ cviFeb|

hYivfóí GmUb tUBU (Ashton-Tate Inc) tKvúvnb tWUvtem c`vKR tcMngs D`vFeb Ktib| tWUv ejZ tKvb Z_ ev Information-tK eSvq| thgb tKvb Avdtmi KgRZPI KgPvix`i bvg, wKvbn, RbY Zvwi L, wkYvMZ thvM`Zv, PvKzqZ thvM`vbi Zvwi L I teZb BZ`w` tiwRóvfi tj Lv `vK| e`wMZ tUvj tcvb WvqixZ wevfbetj vKti bvg, wKvbn I tUvj tcvb b`f tj Lv `vK| GB Z_ ,tj vB nj tWUv| AfbK, tjv tWUv ivLvi tUvej tK tWUvtem etj | GKwaK tWUvtefmi mgwóK tWUv e`vsk etj | GKwU tWUvtefmi th tKvb msL`K mvi Yx tUej `vKZ cvi | ci`úi m`úKAY AfbK, tjv tUej (Table) wbtq tWUvtem MwZ nq| GKwU tWUvtem tUvej KZK, wj mwi I Kjvtgi mgstq MwZ| tWUvtem n`Q AfbK mEvi (Entity) Zvuj Kv thLvfb c`Z`K mE`vK wYQKvix `enkó, wj Qviv Avj`v`v Kiv hvq| thgb GKwU tUvj tcvb MvBtW Avcb bvg, wKvbn, tUvj tcvb b`f GB wZbvU mbr`Kvix `enkó (Attribute) wj tL ivLZ cvi | GB `enkó Abjvqx Avcb tjvKti (hvK GLvfb mE`v ejv n`q) Z_ msiY KiZ cvi | Z_ ,wj GiKg nZ cvi:

Name	Address	Telno
Mohsin	10 College Road	9123962
Zibran	40 Central Road	9560278
Sadik	16 Robert Street	8112501
Anwar	5 Elephant Road	8326132

DtjL: me, tjv bvg, wKvbn, tUvj tcvb b`f Kvi wK| ev`fei mvt_ tKvb wj LjR cvl qv tMfj Zv AvKw`K etj ati wbtZ nte|

Avb`v`gK ev mgZj eivei c`Z`K mwi tK tiKWQetj (Each horizontal row is called a record)| GKwU tiKtW`P c`Z`K AvBtUg`K Kj vg ev wdi etj (Each separate item of information is called a field or column)| Dctii tUvej wji Kj vg wktivv`g Name, Address, Telno wbtq MwZ th wekI AvKwZ. ZvK Structure etj | Kjvtgi

welqe`K tWUv etj | `bwb KvtR Avgiv cZw`b G aitbi Avtiv AtbK tWUv ubtq
KivR Kti _mK thgb, bvg, wKvbn, Avq, e`q, mb, ZwiL BZ`w | KivúDUvti i gva`tg Lg
mntR Ges AvZ Aí mgtq mWKFvte G mKj tWUv cUqvKiY Kiv hvq| tUvj tdiv
tUmetj i Kj vg, tj v nj : Name, Address, Telno |

tWUvtem g`vrbRtgU mWk mgtq cUqvRbxq Z_` mieivn Kti mWk m`všl MhY KivZ
mivh` KitZ cvti | GB mnt`-tg Z_` msMwZ KitZ Ggb mthvM itqtQ th, tj vtK wefbc
`vbtKivY t`K t`Lv hvq| KivúDUvti Z_`vej x GKevi tiL w`tj B cUqvq Zv mntR t`Lv
hvq, AbvUvb Pvj vtv hvq, MYbv, cwieZB A_ev cwieaB Kiv hvq| tWUvtem cUqvY
_vKtj BbtfUix KtUvj, tmj m tiKW, gvtKØ mi mivP Ges Avtiv Ab`vb` KivR Kiv hvq|
Z_` tj v mntR tPrLi mvgtb tctj mtefEg m`všl tblqv hvq| tWUvtem mdUl q`vi
itqtQ tcMtg iPvri fvlv| tWUv cUqvKiYi Rb` GwU GKwU DbZ chqqi fvlv|
tcMtg iPvri ci f`z mstkva`bi Rb` itqtQ DbZgvbi mstkvaB c`wZ| c`vKR w`tg
mP divBj mntRB tcMtg e`envi Kiv m`e| tWUvtem tUvej `Zwi KitZ ntj cUtgB
GKwU KvVtgv (Structure) `va KivZ nte| KvVtgvZ wK wK Dcv`vb (Item) _vKte Zvi
GKwU `ag cUqb KitZ nte| `ag Abvqv AvBtUg, tj vtZ cUqvRbxq tWUv tXivvZ nte
Ges AcUqvRbxq tWUv hv` wQy_vK Zv g`Q tdjZ nte| tWUvtem tUmetj wK wK
AvBtUg _vKte Zv cwiKíbvri mgq tUmetj KZ iKtgi tWUv _vKte Zv RvbtZ nte|
tUmetj i AvBtUg cUv aitbi tWUv ev Z_` _vKtZ cvti | aib, tj v nj : Character,
Numeric, Date, Logical, Memo |

C : Character type : evK`, kã, A`ji, hwiPý, wekI wPý, duKv `vb Ges
msL`v hv wmvie ubKv`k jvM bv, thgb, tivj b`f,
tUvj tdiv b`f, tcvó tKwW b`f A_`f GB Kj vtg `iayeY`
wb`KZ tWUv Ašf` nte|

N : Numeric type : msL`v (`kugK msL`v) hv wmvie ubKv`k e`eüZ nte thgb
e`vsk e`ij vY, ci`vqvq cÜB b`f, teZb BZ`w |

D : Date type : Zwi`Li Z_` GB Kj vtg wj wcx Kiv nq| ZwiL
wb`KZ tWUv GB Kj vtg _vK|

L : Logical : GB Kj vtg m`všl gj-K/hv` wb`kR tWUv GKwU A`ji
w`tg tj Lv nq thgb- nüv/bv Gi t`v`T Y/N, mZ`wq_`vi
t`v`T T/F, bviw/cj`f i t`v`T M/F |

M : Memo : GB wdti evK`, kã, msL`v, wPý BZ`w` _vK| GwU
K`vti Kuvri wdti i gZ| tWUvtem mspvšl th tKvb wekI
tbrU hvri mWk `N` Rvbn tbB tmB aiYi tWUvi Rb`
tgtgv UvBc tWUv e`eüZ nq|

~ž Ae GWžKkb

Field width : Kj vtgi mtePP cł~Zv KZ nte Width G Zv vbt`R
Ki tZ nq| dtj tWUv tXvKvevi mg tq cłE cł~Zvi tekx
`tNq tWUv tXvKv tbr hvq br| thgb Name vdti i
Width 12 t`l qv ntj , bvg, vj 12 etYP tekx ntj vdti
tWUv tXvKv tbr hvtebv|

GB cvBv ai tbi tWUvi Rb` GKUv , iaZcYqel q nj cłZ`tki Width-G mtePP KZ, vj
Aqji ev msL`v GKUv tWUvtZ _vktZ cvti| Logical, Memo Ges Date ai tbi tWUv
UvBtč `qsmuqfvte tWUvtm cłqvRbxq Width vbtq tbq| Numeric Ges Character
UvBc tWUvi t`q t`Kj vg Width KZ nte e`envi Kvi x tK tm vel tq vvxvš vbtZ nq| hv
tKvb Kj vtgi Width Kg t`b Zvntj bvg, vWkvbv mst`c Kti vj LtZ nte| Avevi hv
cłqvR tbi Zžbvq Kj vg Width eo t`b Zv ntj vvt`i `vb AcPq nte| vD tgvv K tWUv
UvBtci t`q t`Kj `kvgtki cti KZ Ni cłqvRb tm vel tq vvxvš vbtZ nte|

tWUvtm g`vbtR tgvU vvt ÷ g (DBMS)

A t b K, vj KivúDUvi tcvM tgi mgštq tWUvtm g`vbtR tgvU vvt ÷ g (DBMS) MvWZ|
tWUvtm vbtqšY, mRb, i qYvte qY c f v Z. Kv t Ri Rb` GB tcvM t g c v v Z e`envi Kiv nq|
GB c v v Z msvkó tcvM tgi GKUv Ask| GB c v v Z tWUvtm I tWUvtm e`envi Kvi xi
gta` mgšq Kvi x mdUl q`vi vntmte KvR Kti |

tWUvtm i qYvte qY: DcvE mst hvRb, mst kvab, DcvE g t Q t`l qv c f v Z. Kv t Ri gva`tg
tWUvtm AvayvKiY Kiv nq| tWUvi Abbtgvv Z e`envi tiva, tWUvi m v W K Z v v b o q Z v
`vb c f v Z. v b i v c E v g j - K Kv R I tWUv i qYvte qY t Yi Aš f z |

tWUvtm g`vbtR tgvU vvt ÷ g Acv t i v l s vvt ÷ t gi, tWUv g`vbtR tgvU K t U v j tcvM t gi
m v t _ m v s v j Z f v t e Kv R K t i | D t j L` th, tWUv g`vbtR tgvU K t U v j tcvM t g c l u q v K i t Y i
mgq tWUv Bbcly, tWUv AvDUclY I tWUv msi qY v p q v v b q s Y K t i | DBMS Gi Aš f z
K t q K v U e`envi K tcvM t g nj : K z q v i j `v s , t q R, v i t c v U , tWUv g`v b c t j k b j `v s , t q R
(DML)| K z q v i j `v s , t q R tcvM t g v U m i j B s t i v R i g Z | e`envi K v i x m i j B s t i v R f v l v q
c l e K t i DBMS Gi gva`tg tWUvtm t` t K Z _` AvniY Ki t Z cv t i b | GB Z _` g v b U t i
c l v k z n q A _ e v K v M t R t j L v n q | G R b` t K v b i K g tcvM t g i P b v i c l q v R b n q b v | Z t e
tcvM t g t j L v i c l q v R b n t j DBMS tcvM t g t j L v i K v R t K m n R K t i t`q | G R b`
e`envi K tcvM t g m i j DML t ÷ U t g v U Aš f z Kiv nq| DBMS Gi Aš f z A t b K
`Z v i e`envi K tcvM t g G a i t b i DML t ÷ U t g v U e v B D v U v j v U Aš f z _ v t K | G m e `Z v i
tcvM t g e`envi K t i tWUvtm i m v t _ m s t h v M m v a b e v tWUvtm A v a y v K i Y m v e |

gvB t v v K i v ú D U v t i e`envi t i R b` A t b K i K g tWUvtm c`v t K R c v l q v h v q | G m e c`v t K R
tcvM t g e`envi K t i m n t R tWUvtm `Z v i K i v m v e | A v a K v i s e v v i R`K tWUvtm tcvM t g
e`envi K t i v b g v j v L Z K v R K i v i m v e a v _ v t K :

- tWUvtm `Z v i I m s i q Y |
- tWUvtm t` t K c l q v R b x q t i K v v c o v I g v b U t i c l k b |
- v i t c v U v W K t g v `Z v i i R b` v e v f b a c v b Z _` v j L t b i e`e`v |

tWUvtem c`vKtRi wBR ^fvlvq tcMog wj tL e`envi Kvix bvbv cKvi RvUj cUqKtYi KvR KiZ cvi b| D`vniY wntmte ejv hvq th, BbtfUix, tc tivj (Pay Roll), GKvDwUs, tgyPwv Z DcvE MhY, RvUj wicvU@Zwi i Rb` e`envi Kvix c`vKtRi fvlvq tcMog ^Zwi KiZ cvi teb|

Gevi GKvU tWUvtem dvBj ^Zwi Kti ZvZ tWUv msthvRb, mstkrab, tgvQv, Bbcy Kti Ges Ktqwi j`vs, tqtR mij fvlvq cKvKti tWUvtem t_tK Z` AvniY Kti gvUti cOkK Kti t`Lvtr nj | Create Teladd UvBc Kti GvUvi tPtC Structure ^Zwi i Kvhfg m`uv`b KiZ nte| Structure Gi cZvU wdi -mbr3Kvix `enkO` Field Name, Type, Width Ges Deeimal Places Kj vq wktivbvq `tftb cOkK nte|

- Create Teladd ←

Field Name	Type	Width	Dec
Name	Character	15	
Address	Character	20	
Telno	Character	7	

Adding records to a file

- use Teladd

Since it is already in use, get to the dot prompt and type

- Append

database immediately gives you a blank record at the end of the file to enter your information.

Name

Address

Telno

The highlighted areas show you how many characters you can enter in each field. When you have finished entering information in a field, just press the ← key to move down to the next field.

Now enter the following names, address and telnos:

Habib	6/9 Tajmahal Rd	8123070
Atik	20 Lake Circus	9111038
Sufia	62 Sobhanbag	9120076
Salim	3/15 Iqbal Rd	9113561

⌘ Ae GW#Kkb

To see what the file looks like now, type

- List ↵

Record #	Name	Address	Telno
1	Mohsin	10 College Road	9123962
2	Zibran	40 Central Road	9560278
3	Sadek	16 Robert Street	8112501
4	Anwar	5 Elephent Road	8326132
5	Habil	6/9 Tajmahal Road	8123070
6	Alik	20 Lake Circus	9111038
7	Sufia	62 Sobhanbag	9120076
8	Salim	3/15 Iqbal road	9113561

Dc̣ti i me , tj v Z_ " ṃuYp̣fc Kvi ubK, eiṿlei ṃt_ tKvb ṃv`k` AvKw`gK|

We 'll use the information in the Teladd file, so type and enter

- use Teladd ↵

Now we will be showing the name and address field of a particular telephone number. Type the command and press enter you will see the following record on the screen

- Display Name, Address for Telno = '8112501'

Record #	Name	Address
3	Sadek	16 Robert Street

Now type

- Quit ↵

to end this session.

Dc̣ti i D`vni Yw eStZ Aṃeav ntj Avevi ax̣ti ax̣ti, cob| ṃeav_uḳtj Avcbvi tKvb
c̣Ẓtẹnki ḲṿụDỤti i gva`tg GB tḲsḳj , tj v AvqẒj Ki ab|



c̣ṿṭṾẸi g̣j`ṿqb: 6.14

A) iP̣ḅq̣j-K c̣ḳæ

1. ẉḷtem ẉK?
2. ṭWUv c̣ṃms ej ṭZ ẉK teṿṭSb? e`ṿL`ṿ Ki ab|
3. DBMS I DML ej ṭZ ẉK teṿṭSb? G̣t`i ṂVb I e`envi Aṿṭj ṿPbv Ki ab|
4. ṭWUṿtem dṿBj t_̣ṭK ẉK f̣ṿte Z_` Avni Y Kịteb?
5. ẉK f̣ṿte ṭWUṿtem dṿBj `Ẓwi Kịteb Ẓv e`ṿL`ṿ Ki ab|
6. dṿBj Ḳj ṿtg Ḳq aịṭbi ṭWUv_̣ṿṭK?
7. th ṭKvb G̣ḲụJ ṭWUṿtem ṂVb Aṿṭj ṿPbv Ki ab|
8. ṭWUṿtem c`̣ṿṭḲṭRi D`ṃteK c̣ẒỌṿṭbi ḅvg ẉK?

cW 6.15

jRK tMBUm

Df`k`

GB cW tk`l Avcib—

- wWvRUvj c×wZ e`vL`v Ki`Z cvi`eb;
- wWvRUvj hšj bvg ej`Z cvi`eb;
- jRK tMBUm e`vL`v Ki`Z cvi`eb Ges
- evj qvb A`ij tReivi c`Z`Ki bvg ej`Z cvi`eb|

wWvRUvj KwúDUv`ii tbc`_ t`_k wbj mfvte KvR K`i Pj`Q thme jRK tMBUm tBme jRK tMBUm-Gi Av`oh`Kg`ŕgZv m`ú`K`Rv`v L`B c`q`v`Rb|

KvD`K h`w` c`k`e`Kiv nq— 12975`k 8798 w`tq` Y Ki`j KZ nte? G c`k`e`D`Ei w`tZ w`b`o`q`B tek K`o` nte| w`K`S` n`v`Zi Kv`Q GKwU K`ij K`j`Ui _v`K`j` G c`k`e` D`Ei tei Kiv tKvb mgm`v`B bq— i`ay`K`q`KwU tevZvg tUcvi A`tc`ŕv gv`| i`aye`o` e`o` Y f`v`M`B bq Sine ev Tangent Gi Ab`v`Z A`_ev Log Gi qvb tei Kivi Rb`I Av`v`i` i` mvi Yx NvUvi `i`Kvi tB— K`ij K`j`U`ii tevZvg tU`c` mivmvi Zv tei Kiv hvq| Av`v`K` m`f`Z`vi` _ia`z`c`v`A`me`vi wWvRUvj B`j`K`U`b` | Avi GB wWvRUvj B`j`K`U`b` i` Ae`vb GB K`ij K`j`Ui | wWvRUvj Nw, wWvRUvj tUj`tdvb Ges Avi kZ kZ wWvRUvj B`j`K`U`b` hšj Av`v`i` c`Z`v`i` b`i` R`x`e`b` thvM Ki`Q bZb gv`v`| Gme wWvRUvj hšj Av`oh`Kg` `ŕ`Z`vi` g`j` i`t`q`Q A`t`b`K` _t`j`v` t`Q`v`U` t`Q`v`U` wWvRUvj eZ`v`i` m`b`q`v`š`Z` Kv`h`ŕ`j`v`c`| GBme t`Q`v`U` t`Q`v`U` eZ`v`i` _t`j`v` Avevi `Z`vi` nq Logic Gate ev h`v`ŕ` tMBU bvgK KZK` _t`j`v` Component Gi mg`š`q`| GBme AwZ ŕ`Z`j`RK tMB`U`i` A`t`b`K` _t`j`v` mg`š`q` `Z`vi` nq wekvj ŕ`g`Z`v` m`ú`b`wWvRUvj hšj`sk`|

GB jRK tMBU ev h`v`ŕ` tMBU` _t`j`vi` Kv`h`ŕ`v`i` Zv tevSvi Rb` wWvRUvj e`e`v`w`K` Zv c`ú`t`g`B tevSv` `i`Kvi` | w`m`v`e`-w`b`K`v`k`i` Rb` Av`g`iv` `k`v`g`K` MYbv c×wZ e`envi` Kw`i` | w`K`S` w`m`v`e` I Z`_` t`c`ú`t`Yi` Rb` KwúDUvi ev Ab`v`b` wWvRUvj hšj` _k`v`g`K` MYbv c×wZ e`e`ü`Z` nq` bv` e`e`ü`Z` nq evBb`v`i` c×wZ bvgK mij Zg MYbv c×wZ | `k`v`g`K` c×wZ`t`Z` e`e`ü`Z` nq` 0 t`_k` 9 ch`š`| GB `k`w`U` A`¼` | Ac`i`w` t`K` evBb`v`i` c×wZ`t`Z` e`e`ü`Z` nq` i`ag`v`i` 0 Ges 1 GB `B`v`U` A`¼`|

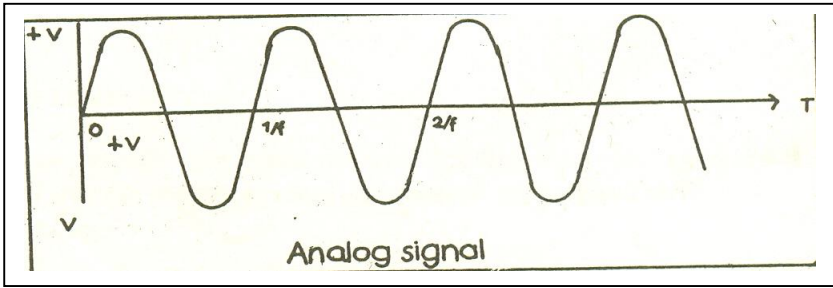

ŕPĪ 6-15.1: wWvRUvj w`m`bvj |

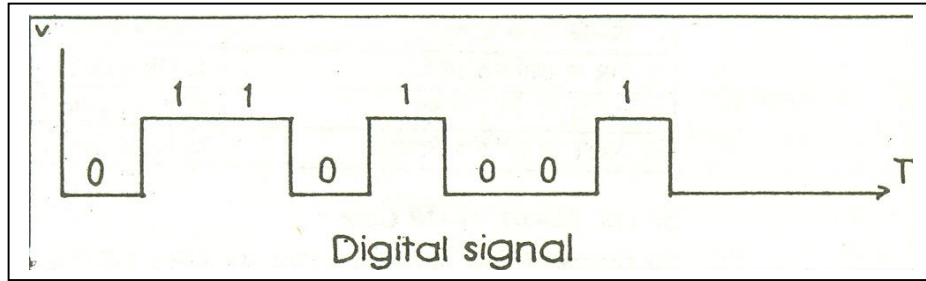

PT
6-
15.
2:
A'v
byj

M mMBvj |

WVURUj cxiZi mvt_ Ab" Btj KUibK cxiZi cAvb cv_R" nTjv Ab" cxiZtZ
 µgcwieZBkxj (Analogue) e`yZK mstKZ e`euZ nq| Aciw tK WVURUj cxiZtZ
 gvT `B ai#bi mstKZ e`envi Kiv nq A_# evBbmi cxiZ e`envi Kiv nq| Avmtj
 WVURUj cxiZtZ mstKtZi `BnU gvT `li _vtK| GKiu D"P wefe `li AciuU wbgawefe
 `li | mvariYZ D"P wefe `li tK 1 weU Ges wbgawefe `li tK 0 weU aiv nq| GB evBbmi
 weUtK jwRK tMBU w`tq cAqvKiY Kiv nq| wKs' GB cAqvKiY Avgt' i cwiwPZ
 exRMwYtZi wbgq tgb Pjt bv| th wbgq GB cAqvKiY Kiv nq ZvtK ejv nq Boolean
 Algebra| 1847 mtj RR#ej (George Boole) bwtg GKRb weAvx hy# A'vj tReiv
 wbgq Kvbly wj wcx Ktib| Zui bvgubymti GtK enj qvb A'vj tReiv ejv nq| GB enj qvb
 A'vj tReivq GKiu PjtKi (tfwi tgetj i) tKej gvT `tUv gvb ntZ cvti | mBP AbU
 A_er AbU er Omuz`U A_er Ov`v hvtk evBbmi 1 A_er 0 w`tq cKvK Kiv nq|

1938 mtj KW g'vbb tUj tcvb mBPs mmiK# wektY Kivi KvR cUg enj qvb
 A'vj tReiv cUqm Ktib| wZub wjtj (Relay) tKwR | Itcb Kivi KvR GB tfwi tgejtK
 KvR jwMb| g'vbtbi GB KvRi OvivB cUkSkjxv Btj KU# enj qvb A'vj tReiv
 cUqtMi er`eZv Abgweb Ktib| Avi tmB t_tK AvR Awā e`envi ntq AvmtQ enj qvb
 A'vj tReiv|

tMBU ejtZ Ggb GKiu eZBx eSvq hvi GK er GKwaK Bbcly mMBvtj GKiu gvT
 AvDUcly mMBvj _vtK| tMBUtK enj qvb A'vj tReiv Oviv wektY Kiv hvq etj GtK
 jwRK mmiK# ejv nq|

Kw'uDUvtii mivtth` BnU evBbmi msL'vi thvMdj tei KitZ ntj , msL'v `BnUi WVURUj
 mstKZ GKiu Btj KUibK mmiK#U cvvtZ nq Ges tmB mmiK# Zr¶Yvr AsK KtI
 thvMdtj i WVURUj mstKZ etj t`q| cTjv e'vcviU wKfvte Btj KUibK mmiK#-Gi
 mivtth` Kiv nq tmU tevSvi Rb" cUtg Rvbn `iKivi enj qvb A'vj tReiv Ges tmB mt½
 Btj KUibK WVURUj tMBU mmiK#_tjvi mt½I cwiPq jvf Kiv `iKivi | wbtP enj qvb
 A'vj tReiv | WVURUj tMBtUi msv¶B cwiPq cvteb|

enj qvb A'vj tReivq i agvT enj qvb thvM I , tYi gva'tg mg`IA¼ Kiv nq|

enj qvb A'vj tReivi wZbuJ tgSuj K wqvqi Dci wfvE Kti wZbuJ cAqv ev`evqtbi Rb"
 wZb ai#bi hy# eZBx e`envi Kiv nq| GBme hy# eZBtK hy# tMBU ejv nq|

Նշանակումը	Նշանակումը
1. OR երեւոյթի տեսակ	1. OR Gate
2. AND երեւոյթի տեսակ	2. AND Gate
3. NOT երեւոյթի տեսակ	3. NOT Gate

1. OR երեւոյթի տեսակ OR Gate

OR երեւոյթի տեսակը բնութագրուած է այնպէս, որ երբ որոշակի մէջէն մէկը կամ քան մէկը 1 (կարգաւորուած) լինի, ապա երեւոյթի տեսակը կ'արտադրէ 1: Այլ կերպ ասած, երբ որոշակի մէջէն մէկը կամ քան մէկը 0 չլինի, ապա երեւոյթի տեսակը կ'արտադրէ 0:

OR Gate-ի A և B երեւոյթի տեսակները մտնելու դեպքերը և արտադրուած երեւոյթի տեսակը C-ով արտահայտուած է հետևյալ աղյուսակով:

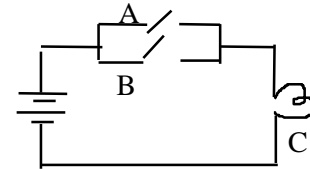
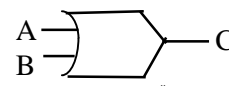
OR				
input		output		
A	B	A+B=C		
0	0	0		
1	0	1		
0	1	1		
1	1	1		

$A+B=C$ արտահայտումը բնութագրուած է այնպէս, որ երբ որոշակի մէջէն մէկը կամ քան մէկը 1 (կարգաւորուած) լինի, ապա երեւոյթի տեսակը կ'արտադրէ 1: Այլ կերպ ասած, երբ որոշակի մէջէն մէկը կամ քան մէկը 0 չլինի, ապա երեւոյթի տեսակը կ'արտադրէ 0:

$A+B=C$ արտահայտումը բնութագրուած է այնպէս, որ երբ որոշակի մէջէն մէկը կամ քան մէկը 1 (կարգաւորուած) լինի, ապա երեւոյթի տեսակը կ'արտադրէ 1: Այլ կերպ ասած, երբ որոշակի մէջէն մէկը կամ քան մէկը 0 չլինի, ապա երեւոյթի տեսակը կ'արտադրէ 0:

$A+B=C$ արտահայտումը բնութագրուած է այնպէս, որ երբ որոշակի մէջէն մէկը կամ քան մէկը 1 (կարգաւորուած) լինի, ապա երեւոյթի տեսակը կ'արտադրէ 1: Այլ կերպ ասած, երբ որոշակի մէջէն մէկը կամ քան մէկը 0 չլինի, ապա երեւոյթի տեսակը կ'արտադրէ 0:

OR Gate-ի բնութագրումը (Parallel) հարկէն կ'արտադրէ 1, երբ որոշակի մէջէն մէկը կամ քան մէկը 1 (կարգաւորուած) լինի, ապա երեւոյթի տեսակը կ'արտադրէ 1: Այլ կերպ ասած, երբ որոշակի մէջէն մէկը կամ քան մէկը 0 չլինի, ապա երեւոյթի տեսակը կ'արտադրէ 0:

OR gate-ի սիմվոլը:

OR, AND Ges NOT GB $\neg Zb \cup tMBU \dagger K$ tgřij K tMBU eřj | Kvi Y GB $\neg Zb \cup tMB \dagger U$
mgřřq evř qvb digřv Abřvqx Ab` $\neg \neg \neg RU$ řj tMBU `Zwi Kiv nq| thgb OR Gate Ges
NOT Gate Gi mgřřq NOR Gate, AND Ges NOT Gi mgřřq NAND Gate,
NOT Ges NOT Gi mgřřq Buffer Gate BZ` $\neg \neg$ `Zwi nq|



cvřVřEi gj`vqb: 6.15

A) iPbřvj-K cřře

1. evř qvb A`řj řReivi $\neg Zb \cup$ tgřij K $\neg \neg$ řv $\neg K$ $\neg K$? GB $\neg \neg$ řv mgřř ev`řvqřbi Rb`
e`eüZ eZřřmgřři břg $\neg K$?
2. hřř Pj K $\neg K$? GB Pj řKi gvb KZ nřZ cvři? GB Pj K řiv $\neg K$ řevřvb nq?
3. $\neg Zb$ Bbcřřekó OR Gate Ges AND Gate Gi $\neg P$ ř, mZ`Kmi Yř (Truth
Table) | evř qvb mgřřKi Y řj \neg ce \times Ki ab|

cW 7.1

Abv̄ubK I Abiv̄ubK ukʻlva ch̄yʻ i e`envi

Dʻik

GB cW tkʻl Av̄ub—

- Av̄ubK ukʻlva ch̄yʻ e`envi i tʻqʻl mgr- PnyʻZ KiʻZ cviʻteb Ges
- Abiv̄ubK ukʻlva ch̄yʻ e`envi i tʻqʻl mgr- eYʻv KiʻZ cviʻteb|

iv̄o^a KZR ukʻlva e`vi `v̄vqZfvi M̄hY Kivi ci thgb GKw̄ tk ukʻlva msL`v me t`tk μgvMZ teto Ptj tQ tZgvb ukʻlvi DcKiY w̄tm̄te eB, LvZv, Kjg, tcwYj, PK tevWʻP mv̄t_ Ab`vb` eūmea wfb̄eagʻ DcKiY m̄shw̄RZ n̄tqʻQ| mgʻtqi mv̄t_ mv̄t_ t`Lv tMj Av̄ubK ukʻlva mev̄B̄K mgv̄fv̄te DcKZ. K̄t̄bv KviY tKvb GKw̄ t`tki me b̄vM̄vi K Dch̄yʻ mgʻtq w̄b̄v̄ ̄ ̄ eqm m̄xvi ḡt̄` GB e`vi m̄shw̄ w̄b̄Z cviʻbv| dtj Av̄ubK ukʻlvi cv̄kvc̄nk Abiv̄ubK ukʻlva e`vi μgk Rb̄v̄c̄Zv jvf Kij Ges Gi c̄v̄Rb̄xqZv Av̄R ersj v`tki gZ Db̄qbkjy t`tk Ab`x̄Kv̄hʻ

m̄v̄viYZ Abiv̄ubK ukʻlvi tKvb `p, Abgbxq ukʻlva μg, cv̄w̄m̄P `v̄Kbv| j`qʻ`tj i Pw̄v̄ I mgq Ab̄v̄v̄i ukʻlva t̄c̄M̄g c̄ʻZ K̄t̄i cv̄w̄m̄P w̄K Kiv nq Ges Zvr̄q̄w̄Kf̄ite m̄vdj` AR̄ Kivi Rb` Av̄RKij G āt̄bi ukʻlva t̄c̄M̄g c̄v̄i P̄j b̄v̄Kv̄ix c̄Z̄v̄b ukLb m̄Av̄j b Kv̄R m̄v̄qZv Kivi Rb` Av̄aK n̄v̄i ch̄yʻ e`envi KiʻZ| Abiv̄ubK ukʻlva m̄v̄viYZ ḡv̄Z cv̄w̄c̄ȳt̄Ki Dci Āt̄bK Kg `īz̄; Av̄t̄vc̄ Kiv nq| n̄v̄ZKj t̄g e`envi i ḡv̄t̄g `z̄ I `v̄q̄fv̄te ukLb m̄Av̄j b Kivi Kv̄R m̄nRj f`, `f̄e`qx DcKiY Av̄aK ḡv̄t̄vq e`envi Kiv nq| w̄gZe`qx t̄c̄M̄t̄gi tʻqʻt̄ G `t̄jv n̄Z cviʻi w̄de P̄v̄U, ēt̄j w̄b tevWʻi īv̄Ob P̄v̄U, BZ`w̄ | eZ̄v̄t̄b Aek` Av̄w̄l t̄Uc K̄v̄t̄m̄U Ges A_ ēv̄B̄ m̄t̄c̄t̄q̄ w̄f̄w̄l t̄c̄M̄g| c̄ʻZ Kiv n̄t̄Q| Rb̄M̄t̄Yi Rb` A_P A_ e`q Kiv m̄x̄e G iKg tʻqʻt̄ CDROM, Internet, Website, Online t̄Kv̄m̄eB Abiv̄ubK ukʻlva Kiʻt̄Yi Āšf̄z̄ n̄Z cviʻi |

cw_exi w̄wfb̄e t`tki, w̄t̄kI Z Db̄qbkjy t`kmḡt̄ni Dvgʻ wekte`ij q mgr Av̄ubK ukʻlvi cv̄kvc̄nk Rb̄MYt̄K Dʻik` K̄t̄i w̄wfb̄e Abiv̄ubK t̄c̄M̄g c̄v̄i P̄j b̄v̄ K̄t̄i `v̄K| ev̄D̄ie c̄v̄i P̄v̄j Z “we love nature”, ōgv̄ I uk̄i i `v̄`v̄, ̄c̄v̄i t̄ek̄O BZ`w̄ w̄wfb̄e Db̄qbgj-K t̄c̄M̄t̄g ḡv̄Z cv̄w̄v̄gM̄i cv̄kvc̄nk ti w̄w̄l /t̄Uj w̄f̄kb m̄v̄v̄t̄i i ḡv̄t̄g cviʻi Ask w̄t̄kI c̄v̄i i e`vi Av̄t̄Q|

f̄v̄iʻZi Rv̄Ziq Dvgʻ wekte`ij q mn (IGNOU), w̄wfb̄e i v̄R` ch̄t̄qi Dvgʻ wekte`ij q c̄v̄Rb̄xq msL`K Abiv̄ubK ukʻlva t̄c̄M̄g c̄v̄i P̄j b̄v̄ K̄t̄i | `v̄Bj `v̄Ūi Dvgʻ wekte`ij q (STOU) Kul. m̄v̄v̄v̄iY Ges t̄Kv̄-Ac̄v̄i w̄f̄ w̄l̄t̄q, cv̄w̄K`v̄t̄bi Dvgʻ wekte`ij q (AIOU) Kul., M̄v̄Q̄v̄j v̄ m̄si q̄Y, ḡjM̄x̄c̄j b, kv̄K-meR̄x̄ P̄v̄l BZ`w̄ w̄l̄t̄q ukʻlva t̄c̄M̄g c̄v̄i P̄j b̄v̄ K̄t̄i | G mg`l̄t̄c̄M̄t̄g t̄w̄ki f̄v̄m̄ tʻqʻt̄ ḡv̄Z cviʻi m̄t̄½ Av̄w̄l /w̄f̄w̄l m̄v̄v̄qK cv̄w̄ c̄v̄i Kiv nq|

wfWV K`vfmU	30 - 60	50 - 99
View Data	1 - 40	5 - 90
Home Computer	1 - 40	10 - 70
Compact Disc	5 - 35	50 - 90
m`v`Uj vBU wUwF	0 - 5	5 - 63
Video Disc Player	0 - 1	5 - 35

mF: wKMvb: 1993

wk`v`v e`e`vq m`u`³ ch`p`MZ e`envi`k tgvUvgw wZbwU c`K `t`at` Lvb hvq:

Btj KUibK gyY e`e`v wbfP Text A_ev cvWmvgM	tKej (Cable), m`v`Uj vBU (Satellite), wfWV wV` e`envi wbfP Lecture-Based tKvm`mvgM	tUuj tcvb, Btj KUibK thvMthvM (e-mail, online) gva`g wbfP Btj KUibK tKvm` mvgM (wbqvgZ I cY-tc`wYK wDUi Ges wk`y`v`xp thS` wUqv wfW`EK)
--	--	---

Gi m`1/2 B`vbxKv`fj h` n`qtQ tUuj thvMthvM gva`g wbfP WWW Gi e`envi, B`Uvi`tbU, AwV I wfWV tUuj Kbdv`i`wYs e`e`v |

Gev`i Avgiv t`Le thme mvgM e`euZ n`Q Zvi g`a` tKvbU GK-cw`v`K, tKvbU w`-cw`v`K ev e`u`-cw`v`K w`g`w`v`i m`v`ebv t`q |

mvi Yx 7.2.2: `hk`y`q ch`p` I thvMthvM gva`tgi e`envi:

GKcw`y`K thvMthvM	w`-cw`y`K thvMthvM
<ol style="list-style-type: none"> gy`Z mvgM Audio/Video Cassettes Audiographics <ul style="list-style-type: none"> Fascimile Slow-scan television Compressed video Telewriting Videotext Videographics wj wLZ wfWV wV` Satellite m`u`v`i 	<ol style="list-style-type: none"> thvMthvM (bb thvMthvM) c`T`i thvMthvM (e`w`³ ch`v`q) tUuj m`v`g` b- Z` (msev`): Audio/Video Computer mie`i`n gva`g: tUuj thvMthvM Instructional Method: `j`MZ Computer wbfP Z` : Audio/Video mie`i`n gva`g: tUuj thvMthvM/gvB`v`vc`m`mi Instructional Method: GKK

mF: wKMvb 1993

tUuj Kbdv`i`wYs e`e`v Dbz t`kmg`ni `hk`v`v`i` cvW Mh`Y mrvqZv Kivi Rb` e`euZ n`Q; m`v`Uj vBU m`y`avi c`v`q`v`Rb nq G`Z |

Dbz w`tk`i` wD`Uwi`qvj e`e`vq wKfv`e` ch`p` e`eyZ n`Q:

- one-to-one telephone tutoring
- audio conferencing
- video conferencing (interactive one-way video)
- teleconferencing: two-way audio programming.

cW 7.3

ıKřıvř tUıj ıfkb: cıÜj ıC cÖZKiY

Dřık

GB cıW tıKřı Aıvıb—

- ıKřıvřj-K tUıj ıfkb cıřVi cıÜj ıC iPbri Kj vřKřkj eYÖv KiřZ cıřeb|

tUıj ıfkb ı- (P tj Lv mřřÜ GB cıřV ıKřıvřj-K ıKÖyAvřj vPbv _vKřQ Ges mıř_ GKıU bğbv ı- (P mřřıvRb Kiv nř"Q|

tUıj ıfkb tıÖMřgi ı- (P cıÜj ıC ıZb cıřıři nř _ıřK:

- cÖıgK ı- (P/cıÜj ıC |
- ıřıvı ı- (P/cıÜj ıC |
- ti Kıvřı ı- (P/cıÜj ıC |

cÖıgK ı- (P/cıÜj ıC: tUıj ıfkb cıřVi Rb" th ı- (P `Zıvı Kiv nř ZıřZ ıbgıřc c`řıřc AıvııY Kiv nř—

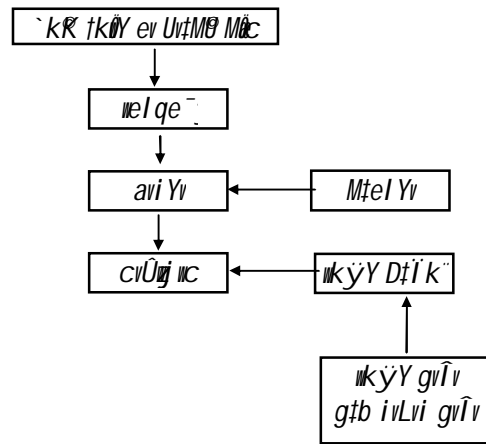

QK 7.3.1: cÖıgK cıÜj ıC cÖıZi c`řıřc|

UřřMÖ Mřc-Gı Pıvıv Aıvıvıx ıel qe" Pqb Kiv nř Ges mřıřıř Mřel Yıv gıvřg mbr³ Kiv nř tKıv arı YıvıU ıKřıv_řı i mıvřb Dc`ıcb Kiv męřPřq Rıaıx| tUıj ıfkb GK Sj K řřL Ges KÉ`ř iřb cıřVi tKıv Ask KZUKzğřb ivLv mře Zı Mřel Yıv gıvřg RıbřZ nř ı- (P cÖYZıřK|

ḡ Ae GW#Kkb

ḡyvgj-K tcMŋg Dc-vcḡbi Df'k" evDwei weifbae-ḡj i tcMŋg KZe:y th QKw e'envi Kḡi b Zvi GKw bḡv ḡbP t' l qv nj | GḡZ GKRB ḡbḡšZ Dc-vcK cvV mḡŰ cŋK Z_ cvb|

OK 7.3.2: ḡbḡm cĪ (bḡvŰ)

tcMŋgi bvg	
tcMŋgi cKwZ	AvbḡmbK (ḡmḡ ÷ vi) AvbḡmbK
tKvḡmP bvg (AvbḡmbK tcMŋgi tḡtĪ ḡvZ eB iḡḡQ)	
ḡbevPZ ḡelqe-	
ḡyY Df'k"	
aviḡYi ZwiL	
cḡḡi mḡe- ZwiL	
AskMḡYKvi xi fḡKv	cvŰḡ ḡc/Kv Kv: i Pbv/Dc-vcb, mḡyirKvi MḡY/cŋvb
Abḡvḡbi ḡvU mgq	
AskMḡYKvi xi Rb" eiVĪ KZ.mgq	
cḡqvRbxq DcKiY	cvŰḡ ḡci Pwv ḡv Abḡvḡi
cvŰḡ ḡc Rḡv vḡbi tkl ZwiL	
ḡḡkl ḡbḡR	

Gfḡte Dc-vcK tRḡb tMḡj b Zvi cvḡVi j y" Mḡci (Target Group) ḡvḡmK cwi c° Zv tKvb chḡḡi Ges Zḡḡ i aviY ḡḡZv KZLwḡ|

Gerī cvŰḡ ḡc i Pbv Kivi cḡqvRḡb Dc-vcKḡK ḡK KiḡZ nḡe ḡyḡbi tḡtĪ A_ḡ ḡZwḡ ḡK tKlḡZ Pvb? `kRḡKi ḡK tKvb ceḡmḡi cḡqvRb? A_ev Ávḡbi th tKvb ḡi B ḡK GB tcMŋḡw Dcḡ ḡi KiḡZ mḡvḡḡ Kḡe?

ḡvḡ ḡ tcMŋḡw tKvb cKwZi Zvi cḡZ Aek"B tLqj iVḡZ nḡe tjLK Ges Dc-vcKḡK| KviY, AvbḡmbK tcMŋgi tḡtĪ cḡZK tKvḡmP ḡvZ cvMvgMḡ iḡḡQ| cḡvi ḡvḡ e'envi Kḡi iḡḡvĪ ḡmB AskUkzDc-vcb Kiv nq hv ḡyḡv_xP cḡy GKv Abḡvḡb Kiv KóKi nḡZ cvḡi| AvbḡmbK tcMŋgi ḡejvq ḡvZ cvMvgMḡ me mgq _vḡK bv ḡKš' GKw mḡvḡ ḡ cvVḡḡ iḡḡQ| PwḡcĪ mḡyirKv jxb mgḡq Dc-vcKḡK G mḡŰ ḡe-ḡw Z Z_ mīeiḡv Kiv nq| mḡḡvs Dc-vcK, cḡhvRK, tjLK mevB Dc-vcbv mḡŰḡḡḡḡ aviYv tḡtj b|

cḡZK ḡyvgj-K tcMŋg cḡZw cvḡV GK ev GKwḡK mḡvḡ ḡ ḡyY Df'k" _vḡK| Df'k" Abḡvḡv cvŰḡ ḡc (Script i Pbv KiḡZ nq| Gici cKḡev Avḡj vPbv mḡ aḡi ḡj-ḡyYxq Ask_ ḡj vḡK tRivḡj vḡḡte Dc-vcb KiḡZ nq| AZGe, ḡyY Df'k" Abḡvḡi tjLK w-i Kḡi ḡbḡPQb ḡelqe-i KZUKzMfḡi hḡḡb| ḡḡ ḡbavPY Kḡi aviYv_ ḡj vḡK ḡj ḡL ḡdj vi mḡ_ mḡ_ cŋK cvŰḡ ḡc ḡwi nḡq tMj |

wfivwi cvUij uc: GB KvR, tjv tkl Kti tj LK wfivwi cvUij uc ij LtZ emtj b Gevi | gvQ
aivi mgq eokxZ dirbv w`tZ nq| me gvtQi dirbv GK iKtgi nq bv| Dc`vcK Zvi
tcMAtgi AvMh mAviKvix GKwU `tk`i eYBv WK Kti tbb| GtK ejv nq Hook ev
eokx| GB `k`wU t`tL `kE Drmivx ntq bto Pto Zvi nvtZi KvR tdtj wkyYxq tcMAtg
tLtz etm hvte|



wP: 7.3.1: Drmiv mAviKvix `k` Hook/eokx|

G mgq tj LK/Dc`vcK eYBvgj-K KvRi K_v wPst/ Ki`eb|

Gici GtKi ci GK `k` cwi µgv WK Ki`eb tcMAtgi tj LK| `k` ci`uiv Ggb nte
thb `kRe,`tK ati ivLtz cvti| Gevi GKwU ci GKwU `tk`i Rb` w`E ij LtZ nq|
ewi`tK Qmei eYBv Ges Wbiv`tK msjvc`vkte| ka Ges `k` Pqb KitZ nq UvtMh
MAtK gtb tittL| cOZ`K `wU `tk`i gta` mautKp Rvj etb t`teb tj Lb hvtz Kti
`k`, tjv thb LvcQvov gtb bv nq| G mgq tj LK wbtRtK GKRB AvMhx `k`Ki fvgKvq
Dc`vcb Ki`eb| tKvb K_v ev tKvb `tk`i mit` wK aitbi hsm1/2Z hvte Zvi WK
Ki`eb wZib cikvcwK| `k` t`tK `kvs`ti hvevi Rb` `kRe,`tK Dchj mgq w`tZ nq|
cOqvRbtevtA GKwU evK` t`tK axij`tq ev` gvi ejteb Dc`vcK G iKg wPst/ Kti
, iazcY`Astki w`E ij LtZ nq| wKs` GKB `k` GKB mit` `gvi t`Lvteb bv| cke
msthvRb KitZ cvtib| ckeKittj `kRe,`tK DEi LtR tei Kivi Dchj mgq`vkte
w`E| wKs` evomZ mgq w`tq uei w3 m10 Kiv thb bv nq tmw`tK j`y` ivLtz nq| wPst/
kw3 i tLB awitq w`tZ nq wkyv`x` i| wKs` tKvb ka, `k` AvPgKv Dc`vcb Kti O`
cZb NUvtbv hvte bv| `k`Ki mvgvRK, wkyYxq cwi`te`ki K_v tj LK KLtbr fjteb bv|

GKevti GKwU gvI Z` w`tZ nq| cOqvRbtevtA fvgKv t`qv DvPZ wKs`
evK` `xN`Ki`eb bv|

tiKwS cvUij uc: Dctii Astki mit` tj LtKi wfivwi cvUij uc iPbv Kiv ntq tMj | gtb
Kiab, Avciub GB cUg GKwU cvUij uc/w`E iPbv Kitj b| AZGe GtK gnov w`E ev
tiKwS w`E Kivi gZ AwfAZv Avcbvi tbb| Avciub Bt`Q ntj ev msthvM tctj tKvb
AwvI e`w3 i mrvh` tteb| G iKg tKvb mrvh` cvevi Avkv bv`vkj th tKvb cOij Z
eB msMh Kti bgbv cvUij uc gtbvthvM mnKvti cob| t`Lteb axti axti e`vcviUv`uo
nte|

Dc`vcK, cvUij uc, cOhvRK, Dc`vcbvi f1/2 me, tj vB GKwU tUij wfkB
tcMAtgi , iazcY`Pj K| Gt`i gta` N10 abvZ`K mautK`vKtZ nte|

~ç Ae GW#Kkb

ti Kwws msµvšl #KQzc#qvRbxq mvstKwZK #Py (wPÎ 7-3.2) Ges kUmg#ni GKwU QK
t`l qv nj Gevi | wfwWI tc#M#g Dc`vcK ntj Gm#ei m#½ Zvü Nubô thwM#thvM`w#cz
nte|

OK 7.3.3: ku eY#v*

ECU:	Extreme close-up (i'agvÎ`k`bxq e`i Ask w#tkl)
VCU:	Very close-up (ga`-Kcij ntZ #Pe# ch#)
BCU:	Big close-up (m#úY#gv_v mg`lc`v#R#jo)
CU:	Close-up (gv_vi Dci ntZ e# ch#, c#t#i tej vq P#B Gi e#v# ch#)
MCU:	Medium Close-up (Dci ntZ e#Ki b#P ch#)
MS:	Medium shot (Dci ntZ t#Kigi ch#)
Knee:	Knee shot (nv#zch#)
MLS:	Medium long-shot (m#úY#Ae# Ges Dci l b#P #KQzAsk)
LS:	Long shot (e`w#i Ae# c`v# $\frac{3}{4}$ ntZ $\frac{1}{3}$ Ask R#jo_v#Kte)
ELS:	Extra long shot (y#z#K#ti e`w#i c#Y#Ae#)

* c#i i c#vi wPÎ`#e` (wPÎ: 7-3.3)

mvavi Y MwYwZK Z`_`

- c#Z tm#K#U wZb#U k# D`P#wi Z nte|
- GKwU wPÎ ev`k` b`b#ct#y 4 tm#K#U_v#Kte c`v#|
- th t#Kib wPÎ ev`k` 2 w#b#Ui t#k GKv#ti c`v#_v#Kte b#|

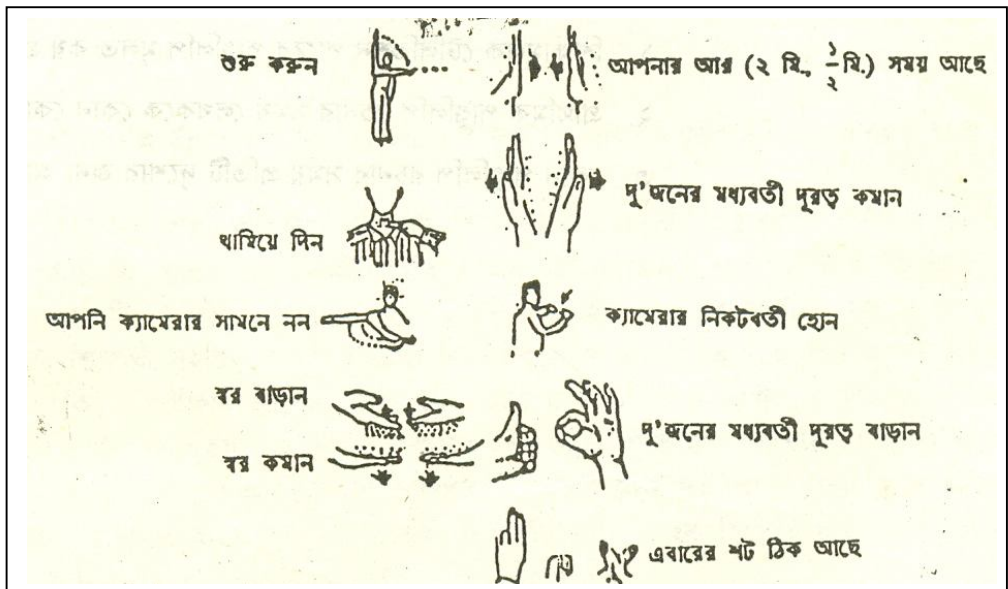

wPÎ 7-3.2: ti Kwws Gi mgq c#hvRK KZR.e`e#yZ w#wfb#mvstKwZK #Py|

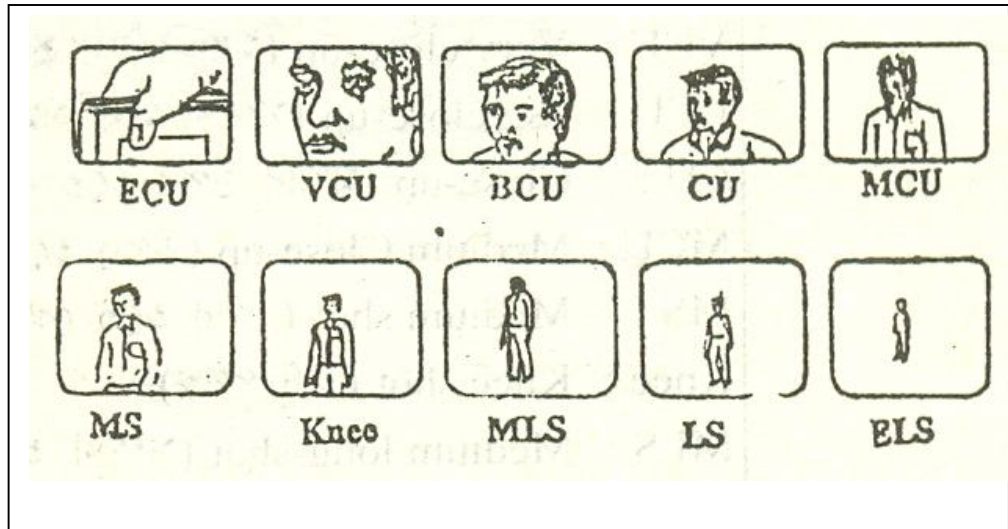

uPÎ 7.3.3: kU eYbV/

eiVvEi gj'iqb: 7.3



A) msuB DEi cke

1. uk'lgj-K tUij wfk b eiVi eiUij uc gj-Z Kq cKv'i i?
2. cU'ugK eiUij uc iPbi mgq tj LKtK tKvb tKvb w' tK `wó w' tZ nq?
3. tKvb eiUij uc iPbi mgq cZwU `tK'i Rb" Avj v`v w' tP_vtK?

hvt`Q| hvt`i Avv`R m½wZ `vKʃe bv Zviv KivúDUvti mnvqZvq th mg`lcvV c0vb Kiv nte tm,tjvi mʒeav MhY KitZ cviʃe bv| dtj 0D>gʕ wkLb0 e`e`vi 0vi meri Rb` D>gʕ `vKʃQ bv|

mʒivs `i-wkʃvi cwi KíbvKvix `j Ges Abjʃ`i gj-wkʃKʃ`i j ʃ`i ivLʃZ nte thb D`P gʃj`i DcKiY, Z` cʃnyʒ, ug-w`lcvKvix cʃnyʒ`i e`envʃii dtj 0D>gʕ wkLb0 Gi gj-bwZ 0meri Rb` D>gʕ0 Ae`vb t_ʃK nvmi tʃq bv hvq|

tlhovi K_v

AvR t_ʃK tek wKQyeQi cʃe-wkʃme`MY we`ij q chʃqi wkʃv_ʃ`i 0wKQywkʃYxq Drill0 AvqEj Kivi Rb` "Programmed Instruction" Ges 0KivúDUvi wbfʃ wkLb0 hʃsʃj e`envi cʃj b Kʃi wʃj b| G Qvovl KivúDUvi KZR.cixʃvi DEicI gj`vqb nZ| cieZʃZ weifbæ wekʃe`ij q wkʃv_ʃ`i DEicI gj`vqb Ges wUDʃUwvi qvj KvʃR KivúDUvti e`envi `iæ nj| D`vniY wntmʃe ejv thʃZ cvʃi Aʃ÷ij qvi KvwUʃ wekʃe`ij q VAX tgBbʃdtʃg LMS KivúDUvi g`vʃbRW wkLb (CML) mdʃl q`vi e`envi Kʃi c0q 12000 wkʃv_ʃ`i AMwZ gj`vqb Kʃi, Aʃ÷ij qvi KBYj`vU cʃnyʒ wekʃe`ij q GK j ʃ`i wkʃv_ʃ`i K enw R wUDʃUwvi qvj mʒeav c0vʃbi KvʃR KivúDUvi e`envi Kʃi|

mdʃl q`vi Dbqʃbi gva`tg KivúDUvi wbfʃ wkLb Abjʃ`i wkʃKʃ`i KivúDUvi weʃkl Áʃ`i mnvqZvq c0qvRbxq mdʃl q`vi cʃZ KitZ nq| G mgq `j MZ chʃqi KvR mʃavi YZ wʃgʃeʒ QK Abʃvʃi Kiv nq|

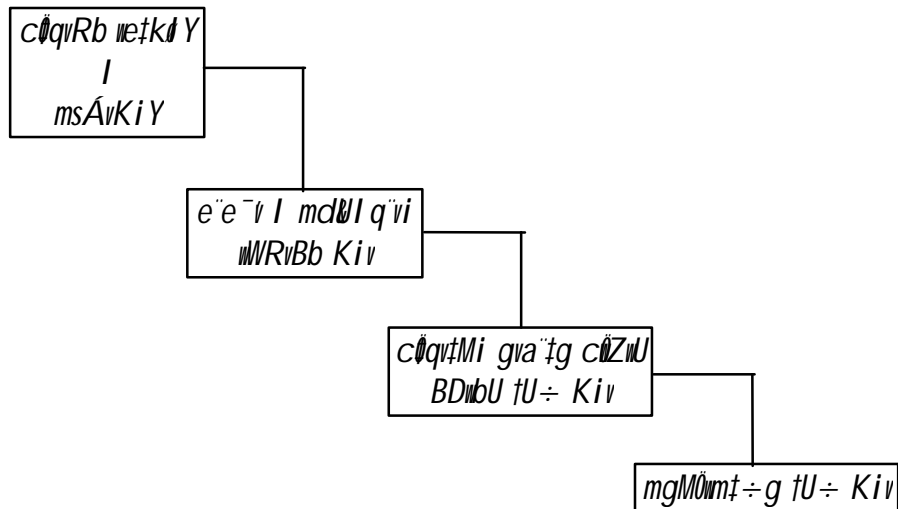

wP 7-4.1: mdʃl q`vi cʃqʃbi 0Rj c0vZ0 gʃWj 0 [Drm: wchij cʃn I tRbwKbʃn (1997)]

Dcʃi wPʃI Avgiv t`LʃZ cww`Q, tKvb tKvʃm`KZUKzGes wK cKwZi cʃnyʒ mʃthvRb Kiv nte Zv 0c0qvRb weʃkl Y0 chʃq wPwYz Kiv nq| Gici wnt÷g wVRvBbvi mdʃl q`vi Gi wVRvBb cʃZ Kʃib| cʃZKZ.gʃWj KvʃRi wKbv Zv c_wKfʃe cixʃʃYi gva`tg t`Lv nq| Gici mgM0wʃ÷gB cixʃʃYi gva`tg hvPvBKZ.nq| Gici tKvm`c0qʃKvix

ḡ Ae GW#Kkb

`j GB Askw#kI#K mgM#Kvm#li Ab`vb` cvVmgM#i mv#_ ms#hvRb K#i Gi , Yv, Y,
KvhR#vi Zv hvPvB K#i b|

gvV ch#qi #KQyk#v_#`i Dci Gi c#q#Mi gva`tg th djvdj cvl qv hvq Zvi Dci
wfv#E K#i #Kvm#li wv#`# #K#v tc#M#tg A#f# Kiv nq|



cv#V#Ei gj`vqb: 7.4

msv#B D#Ei c#e

1. D#g# #kLb e`e`vq K#úDUvi e`env#i i cwi wa KZ`#?
2. `Av#K n#i K#úDU#i e`envi ms#hvRb Kivi dtj D#g# #kLb e`e`v Gi
`D#g#`#`e#k#` nvi#`Q#- e`vL`v Ki#b|
3. md#l q`vi Db#t#i `Rj c#vZ g#Wj`# e`vL`v Ki#b|

cW 7.6

I tpe gva'tg wLb

Df'ik"

GB cW tk#l Avcb—

- փi wq'v_#`i Rb` I tpe gva'tg wLb mvgM c'Z I tcoY tKSkj eYv KiZ cviteb|

Avcbviv BwZc#eB wefba:cv#V WWWW ev Iqv' ©IqvBW I tpe m#t'U mrvaiY Z_` tctqtQb| GB cv#V Avgiv Rvbe wKfite I tpe tCR m#p Kivi gva'tg wq'v tcoMg wq'v_#`i wBKU Dc`vcb Kiv m#e| wefba:wek#e`ij tqi D`vni#Yi gva'tg G m#t'U e`vL`v t` Iqv n#t'Q|

Avtgvwi Kiv h#yivto#i gvUvbr t#U wek#e`ij tqi Kw#uDUvi weAvb wefivM Web-based Introduction to Computer Science I Ges II (CS 301) wktivbvtgi GKw 10 t#vW#Ui tKvm#c'Z K#it'Q| GB tKvm#f#vEK wKQyZ_` Avcbviv GB cv#V cv#t'Qb Ges cv#vUi gva'tg avi Yv cviteb wKfite GB ai#bi cvV c'Z Kiv nq|

GB tKvm#tj vtZ gv#t#vWq#v A_vi Iqv'i (Macromedia Authorware) Ges m#D'U dR(Sound Forge) e`envi K#i I tpe wbf#p cvMvgM c'Z Kiv n#t'Q| c'Z t# GB wq'v tcoM#tgi wq'vKMY w#xv#s#l M#Y K#i wQ#j b th I tpe m#BU Ges w#vW (CD) `#vU gva'gB e`envi Kiteb| th#nZzm#W c'Z K#tj Zv `#ZZvi m#t_ cwi eZ# Kiv m#e bq tmR#b` tKvm#c'Z K#i KMY c'Z wZc#e#w#xv#s#l cwi eZ# K#i i'agv# I tpe m#B#Ui gva'tg cvMvgM c'Z K#tj b|

w#v#gs ch#y# e`envi Kiv nj GB cvMvgM c'Z wZ#Z| GB ch#y#i m#vqZvq wq'v_#`i cvV L'U L'U Astk wef#3 K#i cv#v m#e| dtj c#qvRb#v#ta Gi Askw#t#k#l `fZg mg#t#q cwi eZ# Kiv#l m#e| HTML ev n#Bcvi tU· U gvK#v# j`vs_#tqR (Hyper Text Markup Language) e`envi Kiv n#t'Q GB ai#bi cvV c'Z wZ#Z|

HTML m#t'U we`v#i Z Rv#t#Z n#j t#Kub Av`k#v m#v#b#e Kw#uDU#i eB cot#Z n#e wq'v_#k|

Kw#uDUvi weAv#bi gZ Abj#c th tKvb wq'v tcoM#tgi cix#v#v#i ev j`v#t#i Uixi c#qvRb Av#t'Q| th#nZzDctiv#3 tcoM#tgi cvV I tpe m#B#U Dc`vcb Kiv n#t'Q tm#nZztKvm# c'Z ZKvix Uxg o#cKZ. cix#v#v#i o cwi e#t'Z oAcKZ. (Virtual) cix#v#v#i o avi Yv t#t'Q w#t'Qb Ges Zviv Net Meeting e`envi#i gva'tg wq'v_#`i wB`^Kw#uDU#i m#vqZvq o cix#v#v#i o Av#t'Q Rb K#i#t'Qb| Z#v#q cv#vi m#t# j`ve K#v#Ri m#v#Z i#v# K#i#t'Qb; `# ai#bi j`ve K#v#R m#th#v#Rb Kiv n#t'Q GB tcoM#tgi—

- Bb-j `ve Ges
- ukwDj wj `ve|

tbU ugUUs-Gi Dtg lthvM` eukómgR thgb, Mí Kiv (Chat), mv`v tevW®(Whiteboard) AvvI -wfvI KbdvfiwYs Ges cŕqM fivfvvMKiY (Application Sharing) e`envi Kiv ntqtQ cixŕvMvi e`e`vcbrq| cŕZevi ukŕŕv_ŕZvi KivúDUvfi gva`tg tbU ugUUs WvDb tj vW KtiŕQ (www. emicrosoft.com) | GRb` tbU ugUUs-Gi mvfŕ (cs. mtech.edu) e`envi Kiv ntqtQ| cixŕvMvi KvŕRi mnvqZvi Rb` mnvqK ukŕŕŕKi (Facilitator) e`e`v iŕqtQ GB ukŕŕv tcŕMŕtg|

weŕkl KvŕRi aviv

cŕZvU ukŕŕv_ŕK cŕg cixŕvMvi GKvU lŕqe tcR `Zvi Kitz ntqtQ| cixŕvMvi KvŕRi wŕcV, wbaŕZ KvR (Assignment), cixŕv meB MŕY Kiv nq BvUvŕŕŕUi gva`tg|

gwëvUvqv tj Lbx mvgMŕi e`envi

A`vmtgUk Gi Uŕek (Toolbook), B`YUj kv` Gi tWtgkv` (Demoshield), g`vŕvUvqv A_vilq`vi (Authorware) tj LK mvgMŕi ga` t`ŕK A_vilq`vi 4.0 e`envi Kiv ntqtQj tKvŕvMŕi lŕqe tcR `Zvi Kivi Rb`|

tKvŕvMŕi cŕZKiY

cv`mŕPvU GKvU cŕGKvŕWvK ermŕi 30 Kg`mBvne`vcx wQj, GŕZ 28 vmtg`vi tŕvUv gŕŕbi cv` wQj | Dc`vcŕbi mgq GKvU bZb aviv cŕZŕ Kiv nj - 50 vgvbŕUi DcŕvMx cvV vntmŕe bv Kŕi GKvU aviv ev KŕqKvU mgagŕq aviv GKmvŕ_ Dc`vcb Kivi tKŕkj wAej ŕb Kij b tKvŕvUx|

lŕqe tcR Gi gva`tg th mg`l tKvŕvMŕi Dc`vcb Kiv nq ZvŕZ KivúDUvfi mdwI q`vfi wvfbwAvBKb (Icon) e`envi Kitz nq| gvBŕvUvqvŕZ tgvU 16vU AvBKŕbi ga` nŕZ Dcŕiv` tKvŕvMŕi Uxg cŕZvU Dc`vcb bqU AvBKb e`envi Kŕivŕŕb| cŕZvU g`vc AvBKŕbi gŕa` cŕkŕ (Display), MvZ (Motion), gŕQ tdj (Crase), Aŕcŕv Ki (Wait), KvR w`i Ki (Frame Work), avŕb (Sound), iia Kivi cZvKv (Start Flag), tkl Kivi cZvKv (End Flag), g`vc (Map) BZ`w` wQj |

ukŕŕv_ŕe, Avcbviv hviv KivúDUvfi KvR Kŕi Af` Zviv wŕŕQb AŕŕK gvBŕvUvqv cvlqv cŕqŕU (Microsoft Power Point) KvR Kŕi vŕKb| g`vŕvUvqv A_vilq`vi (Micromedia Authorware) e`envi Kŕi gwëvUvqv wBw `Zvi Kiv cŕq GKB iKg mnR|

ᄡ Ae GW#Kkb

gvUvbn nekpe`ij tqi GB tKv#mP cŃZKviK Uig cŃg erm#i ubeŃxKZ. wkŃv_#`i
gZvgZ msMh K#i#Qb tKvm#Ńi weifbaw K m#fŃ| hLb Zv#`i gta` t_#K Drop-Out
t`i Z_` we#k#Y Kiv nj Zviv Rvbj g#Lvg# ev mbvZb wkŃv c#v#Zi tKvb weK#`i tbB|
Avq#`i t`#k l#qe t#R Gi gra`#g D`P wkŃv t#M#tgi tKvm#Dc`vcb Kiv GB g#t#Z#
m#e bq Z#e eZ#vb K#v#úDUvi c#v#i AM#v#Z mK#j i tR#b ivLv D#PZ| Aek` th
M#Z#Z thv#v#thvM c#v# DrKlZvi GK avc t_#K cieZ# av#c hv#`Q Zv#Z t`Lv hv#e
weifbaw nekpe`ij q AvP#i B wkŃv_#`i Rb` Gi Kg Web-Base tKvm#Z#i Ki#Qb|



cv#V#Ei gj`vqb: 7.6

A) ms#v#B D#Ei c#k#e

1. l#qe gra`#g wkL#bi t#v#t` wk ai#bi h#š#v#Zi c#ŃqvRb nq?
2. l#qe gra`#g wkLb Kv#R K#v#úDUvi md#l q#v#i i_ i#z#; KZLvb?
3. we#v#bi cir#v#v#i ag#tKvm#Ńl#qe t#t#R wkfv#e A#š#f# Kiv nq?
4. l#qe t#t#Ri gra`#g tKvm#v#v#M# cŃZ Kivi tKvb ai#bi AvBKb (Icon) e`envi
Kiv nq| A#šZc#v#Ńv c#v#v# AvBK#bi bvg Ki#b|

ᄡ Ae GW#Kkb

gše

Dctiv³ B-tgBj Avtj vPbvU#Z we#kji newfbæt`k t_#K newfbænk#v c#Z#v#bi weÁvb
#k#KMY AskM#Y K#i#Q#j b| c#k#e#t#j v AZ`Š mg#qvc#thvMx #Qj , we#kl Áe#`i D#i l
h#Mvc#thvMx #Qj | e`Z G ai#bi B-tgBj AvŠR#ZK Avtj vPbvq L# A_#`q l nq bv|
Db# Ges Db#qbkxj we#kji we l q we#kl ÁMY GKB we l #qi Dci Avtj vPbv K#i ev`eag#
#m#v#š#Áv#t#Z cv#i b|

If you can post a flier about the discussion in your school or organization, e-mail Paula Fleming, WEEA's marketing communications director, at WEEACTR@edc.org or call (800) 225-3088; TTY (800) 354-6798.



cv#V#i gj`vqb: 7.7

ms#B D#i c#e

1. Ab-j vBb #k#vq #K ai#bi m#eav cv l qv m#e?
2. Db# we#kji wek#e`ij q ch#q Dc`mcZ Ab-j vBb #k#v#m# D#j #L#thvM` #K ai#bi m#eav Av#Q?

~ç Ae GW#Kkb

Avgi v Gevi gÿYi mbvZb I WwUmc e'e ~vi Zj bvgj-K wPÎ cıvıcvıw k t`Le|

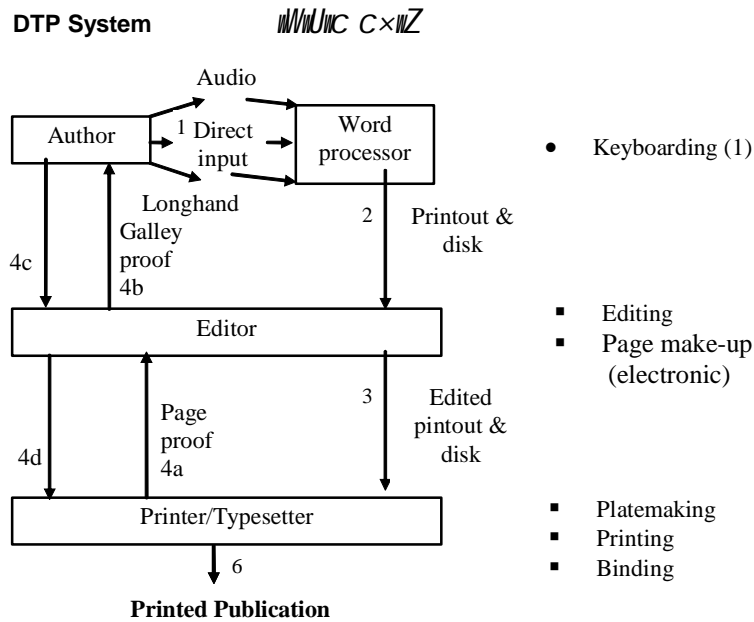
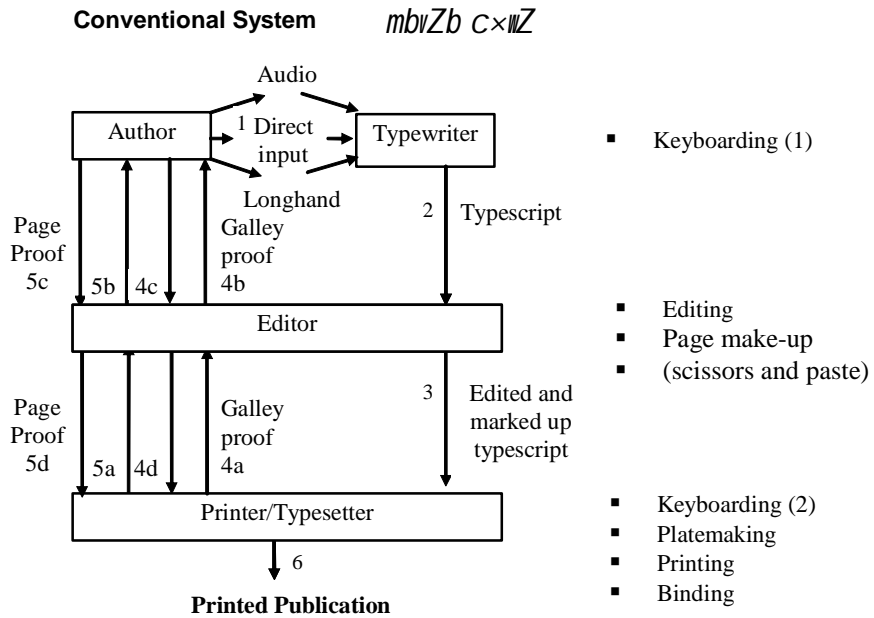

wPÎ 7-8.1: gÿYi mbvZb I WwUmc c×wZi chıqıµg|

wPÎ ~BwUz Bsti wR kâB ivLv nj | Avcbvıv t`Lız cvı"Qb th tj LK mbvZb cÛvq UvBg tgvıktıbı mrvqZv ıbtıeb wKŞ' WwUmc c×wZz wZıb I qvW©cÖmmı e"envı Ktıb| mbvZb cÛvq tcRtğKvıci KvR mgq mıtç¶: KwP Ges Avarı cÖqvRb wKŞ' WwUmc cÛvq GB

Kivru Btj KUbK gva`tg Kiv nq| wP` j` j` Kijt B eStZ cvi`eb wWuuc cXwZtZ Kg mgtg SKStK cwi`QbaeB cvl qv m`e|

mbvZb cUvq thfite cyK gyYi Kiv hM hM ati ntqtQ AvR KivuDviti i mnvqZvq ZvtZ myi- c`hix cwi eZ` GtmQ| GLb Avi QvcvLvbvq klgK`i M`vj x (Galley) mivRvtZ nqbr| eZ`v` Btj KUbK tCR tgKvc tgmktbi mnvqZvq Page Maker, Quark Xpress, Ready Set Go, Ventura Publisher BZ`w` tC`M`gi gva`tg tU- U msthrB Kiv, wP` mWk `v`b emvb BZ`w` Kiv, tj v nq| tCR tgKAvc KivR mgvB Kti cvW hLb KivuDviti `sZ (Memory)tZ msiv`Z nq ZLb ej v nq GuU K`v`giv cU`Z (Camera Ready) Ae`vq i`qtQ|

gj- tU- U wbtg` fite mivRvbr nq-

- Aa`vq wktivbvq|
- wefvM wktivbvq|
- AvŠtefvM wktivbvq|

wWuuc tU- U wK avivq `Zwi Kiv nq?

m`uv`K Ges tj LK i`iaet`tKB KZ, tj v, iaZcY`elq w`i Kti t`teb, G, tj v nt`Q-

- tU- U Gi `N` (tKvb tj Lv 2500 k`ai nte w`i Kiv ntj cieZ`Z Zv 2000 k`a ev 3000 k`a tKvUjB ifc wbtZ cvti br| GiKg ntj AtbKt`j`i m`uv`KtK Zvov`tor Kti NvUvZ ciY Ki`Z nq ev AwK AskUKz`KtU tdj tZ nq)|
- wP` (tj LK wP`, M`d mieivn Kijt ZvtK msL`v, AvKvi Ges cKwZ. `uofite D`j` Kijt nte, thgb 10 x 8 Bw`i wZvU w`i wP`, 3wU gv`c BZ`w`)|
- ÷vBj (j` j` i cU` `w` ti`L fvlv e`envi Kiv nq, gtb ivL`Z nq Zv`i ce`Z` Avtbi cwi`a KZLvb)|
- j` j` (j` j` Abviti Avtbi ch`q w`i Kiv nq| G mgq tLqj ivL`Z nq GKB w`l`qi Dci m` evRviti Avi wK ev KquU eB cKwKZ ntqtQ, BZ`w`)|
- mgq (tj LKtK Ppvš mgq m`xgv m`tU cU`tgB AewZ Ki`Z nte KviY m`uv`KtK w`v` mgtqi g`a` UvBc tmUs, c`d mstkrab Kiv, tgK-Avc `Zwi Kiv me KivRB Ki`Z nq)|
- cU`v`bi dg` (tj LK tj Lvmn Ab`v` Avb`w`K DcKiY wK AvKviti t`teb Zv c`eB w`i Kti wbtZ nte; A` wZvb K`v`giv cU`Z Kuc t`teb br, cvU` wci w`t`U t`teb Zv w`i Kiv nq)|
- m`y`bx (tj LKtK wK aitbi m`y`bx t`lqv nte Zv w`v` Kiv cU`qvRb| Rvb`j` tj LKtK w`v` w`d t`lqv nq Zte cy`Ki tj LK m`vavi YZ iqvj wU tctq`v`Kb)|

